

Tel Aviv University

The Lester and Sally Entin Faculty of Humanities

Department of Linguistics

**Strictly incremental parsing, unconscious deletion
and c-command**

MA thesis submitted by:

Omer Rosenbaum

Thesis advisor:

Prof. Tal Siloni

July 2018

Contents

1	Introduction	7
2	Garden Path phenomenon	7
3	Theta Attachment	10
3.1	Employing Theta Attachment	11
3.2	Optional garden path sentences	17
3.3	Issues with Theta Attachment	18
3.4	Interim Summary	20
4	Review of current suggestions regarding reanalysis	21
4.1	Pritchett (1992) - OLLC and rebuffering	21
4.1.1	Dominance	21
4.1.2	Government	25
4.1.3	Rebuffering	28
4.1.4	Issues with Pritchett's (1992) theory	30
4.2	Structural Determinism	35
4.2.1	Determinism	36
4.2.2	Examples under Structural Determinism	38
4.2.3	Head-final languages	41
4.2.4	Issues with Structural Determinism	52
4.3	Reanalysis by movement - Siloni (2004)	58
4.3.1	Structure building operations	58
4.3.2	Licit Reanalysis	60
4.3.3	Issues with reanalysis by movement	69
4.4	Interim Summary	73
5	Incremental Parsing	73
5.1	Evidence from Garden Path sentences	75
5.2	Evidence from on-line parsing experiments	80
6	The current proposal	81
6.1	Structure construction	81
6.2	Interim Summary	97
6.3	Reanalysis and constraints	98
6.4	Predictions of Unconscious Deletion regarding other garden path sentences	124
6.4.1	Reanalysis triggered by a theta-assigner	124
6.4.2	Garden Path sentences involving scrambling in Korean	136
6.5	Processing phenomena other than garden path	141
6.6	Predictions that stem from the current proposal - easy displacements	145

7	Unconscious Deletion in head-initial languages	152
7.1	Ambiguous “her”	152
7.2	Globally ambiguous sentences	154
8	Discussion	157
8.1	The grammar and the parser	157
8.2	Empty categories and the garden path phenomenon	158
8.3	Is precedence a necessary part of Structural Determinism?	160
8.3.1	Clausal-complementizer/Relative-clause Ambiguity	160
8.3.2	Object/Reduced-relative	163
8.3.3	Oblique-comp/NP-modifier	165
8.3.4	Matrix-verb/Reduced-relative	167
8.3.5	Possible implications	169
8.3.6	Conclusion	171
9	Summary	172
10	Appendix - Sentence Types	175

Abstract

This thesis investigates the underlying mechanisms of the human sentence processor. For this purpose, I consider sentences such as the following:

(1) While Mary was mending the clock started to chime. (Frazier & Rayner (1982))

(2) John told the man that Mary kissed that Bill saw Phil. (Crain & Steedman (1985))

The examples above are called garden path sentences. The human parser successfully analyzes such sentences only after perceptible breakdown and conscious reanalysis.

The garden path phenomenon raises two main questions:

First, given a locally ambiguous segment (e.g., "While Mary was mending the clock..."), what determines which parse the parser initially pursues? Why does the parser consistently prefer the reading where *the clock* is the object of the verb *mending*, rather than the subject of the subsequent clause, as in (1)?

Second, which sentences yield a garden path effect? Many sentences in natural language consist of local ambiguities, and some even involve reanalysis but still do not result in a conscious breakdown. What distinguishes the garden path sentences from other sentences?

Most previous research on this topic has relied on evidence from head-initial languages. I consider three theories that aim to provide answers for the above questions, those made by Pritchett (1992), Gorrell (1995) and Siloni (2004), and show that all three encounter difficulties in head-final languages.

I then provide my own proposal regarding the mechanisms underlying the working of the human parser. I consider the incremental nature of the parser, and provide evidence in favor of strictly incremental processing. Specifically, I rely on garden path sentences from head-final languages to demonstrate that the parser does not store input until the appearance of a licensing head.

I claim that the parser incrementally constructs a tree description during processing, and provide an algorithm to account for ambiguity resolution. Unconscious reanalysis is possible if it consists of adding relations to the computed description, or deleting relations in a very specific structural configuration. These relevant relations and structural configuration have recourse to basic structural notions such as dominance and c-command. This finding suggests that the same structural notions are relevant in both production and processing.

The current proposal accounts for a variety of data from head-initial languages such as English and Hebrew, as well as head-final languages such as Japanese, Korean and Chinese.

Acknowledgements

I have been extremely lucky to be surrounded by brilliant and encouraging people, whose influence on me and on this thesis has been enormous.

First and foremost, I would like to thank my advisor, Prof. Tal Siloni. In the spring of 2016, Prof. Siloni taught an “Advanced Syntax” course, where I first encountered the garden path phenomenon. Her teaching inspired me to keep asking questions about the underlying mechanisms of the human parser. I would like to thank Prof. Siloni for encouraging me along the way, for fruitful thinking sessions and for always pushing me further. Her vast knowledge and passion for syntax have influenced me deeply. I could not have asked for a better advisor.

Noa Brandel has been a mentor for me from the very first time I attended a syntax class, which she taught. First as an instructor, and later as a colleague and friend, she has shaped the way I view syntax.

I am grateful to Dr. Irena Botwinik for her insights, as well as for the motivational and relaxing talks. She taught me that linguistics can be both fun and serious at the same time.

Prof. Fred Landman provided many valuable observations along the way. While presenting him my initial ideas he was quick to identify issues that needed further consideration, and later offered his insights both in writing as well as face to face.

Dr. Aya Meltzer-Asscher has greatly influenced my interest in processing, and processing head-final languages in particular. I would like to thank her for our valuable discussions and for always being happy to offer her wise advice.

I am grateful to Dr. Roni Katzir for making me realize how amazing linguistics is. In the fall of 2014, Dr. Katzir taught a course in computational linguistics, which he let me attend without having any prior knowledge in linguistics. This course, together with Dr. Katzir’s seminars, have led me to study linguistics. I would also like to thank Roni for giving me the opportunity to teach an “Algorithms for Computational Linguistics” course on his behalf.

I have also had the luck of being surrounded by brilliant students, who studied and taught in Tel Aviv University’s linguistics department by my side. Neta Haluts and Yuval Katz shared my growing passion for linguistics, listened carefully to my ideas and offered insights along the way. Our conversations taught me that discussing linguistics at night can be exceptionally fun. Our friendship has been extremely valuable to me. I have also had the pleasure of being guided by inspiring fellow teaching assistants - Yakir Dalal, Hila Davidovitch and Daniel Asherov, who were always happy to help and make the entire process much more enjoyable.

Nanako Kojima has greatly helped me with clarifying Japanese data, asking for judgments from native Japanese speakers as well as providing her own. Kathrin Anne Karsch, Alicja Michalik and Simon Josef Svoboda have provided their judgments and insights regarding German sentences.

Daphne Gray-Grant’s website, “Publication Coach”, has provided me with inspiring as well as technical advice that has greatly helped me with my writing

process.

Prof. Naama Friedmann has greatly influenced my academic path. As head of the Adi Lautman Interdisciplinary Program For Outstanding Students, she has always encouraged us, the students of this program, to follow our interests, and has provided personal guidance that I value very much.

I would like to thank my mother, Orit Rosenbaum, and my father, Dr. Ziv Rosenbaum, for always being a role model for me and supporting me in everything I have done. Specifically, I would like to thank my father, who has read various versions of this work and provided meaningful comments and insights, despite having no formal background in linguistics.

1 Introduction

Much linguistic research has focused on how people understand natural language sentences. In some way, humans combine the words of an utterance and yield the full interpretation of a sentence. Marvelously, this task is something that a functional human brain can achieve efficiently and effortlessly, even automatically. Yet, the task of understanding natural language sentences is not simple, as such sentences may involve various elements, structures, and ambiguities.

Many questions have been raised regarding the human parser. For instance, what representations does the parser use in order to describe the sentence while it is being processed? What algorithms are used in order to construct those representations? How does the parser deal with ambiguous sentences, or parts of sentences? Is the parsing mechanism universal, or does it differ when processing different languages?

One way to investigate the underlying mechanisms of the human parser, is to look at edge cases where the automatic processing done by the human parser fails, even though it is faced with a grammatical string. Sentences of this kind of are called *garden path sentences*. A comprehensive theory of the human sentence processing mechanism should account for these cases and explain why they cause the parser to fail, while also predicting parsing success when processing other sentences.

In this paper, I would like to use the garden path phenomenon in order to investigate the underlying mechanism of the human parser, and provide a comprehensive theory of sentence processing. The outline of this paper is as follows: In section 2, I will describe the garden path phenomenon, and posit two major questions that arise from it regarding the human sentence processor. In section 3, I will review Pritchett's (1992) proposal labeled the Theta Attachment, which describes what drives building operations by the parser. In section 4, I will review three different theories that aim to account for the garden path phenomenon, and provide counterexamples for each one of them - that is, regarding each theory, I will provide examples that the theory fails to account for, particularly in head-final languages. In section 5, I shall consider the incremental nature of the parser, and provide evidence in favor of strictly incremental processing. Then, in section 6, I will suggest my own proposal regarding the garden path phenomenon, as well as the underlying mechanism of the human parser. Section 7 will demonstrate the application of the mechanisms suggested in this paper in head-initial languages. In section 8 I will discuss some issues that arise from the findings presented in this paper.

2 Garden Path phenomenon

Consider the following sentence, taken from Frazier & Rayner (1982):

- (1) _{GP}While Mary was mending the clock started to chime.

The sentence above is an example of sentences that are very difficult for

the human parser to process. These sentences, which the parser successfully analyzes only after perceptible breakdown and conscious reanalysis, are called “garden path” sentences. The name suggests that in the process of parsing the sentence, the human parser is led down the garden path. While parsing a sentence such as (1), humans feel a conscious effect of surprise. At first, the sentence might seem ungrammatical. Yet, this effect disappears once the sentence is successfully reanalyzed. Furthermore, once the parser is acquainted with the sentence, it manages to successfully analyze it again without difficulty. I will mark sentences that cause such conscious parsing difficulty with $_{GP}$, and sentences who don’t as $_{OK}$.

In the process of parsing (1), the parser reaches a point where it is facing the segment in (2a). This segment is (locally) ambiguous - as it may be completed as in (2b), where *the clock* is the complement of the verb *mending*, or as in (2c), which is identical to (1), where *the clock* is the subject of the subsequent clause. While (2b) does not cause any conscious parsing difficulty, (2c) does.

- (2) a. While Mary was mending the clock
- b. $_{OK}$ While Mary was mending the clock it started chiming.
- c. $_{GP}$ While Mary was mending the clock started to chime.

Garden path sentences often involve such ambiguity. Yet, the ambiguity itself is not sufficient to cause the parsing difficulty. Consider, for instance, the ambiguous sentence (3), taken from van Gompel et al. (2005).

- (3) $_{OK}$ The burglar stabbed only the guy with the dagger during the night.

In the above sentence, the $_{PP}$ [with the dagger] can be either attached to the $_{DP}$ [the guy], meaning that the guy with the dagger was the to only one to be stabbed during the night, or attached to the $_{VP}$ [stabbed only the guy], meaning that the dagger was used to stab only the guy during the night. This sentence, like many other ambiguous sentences, does not involve a processing breakdown.

- (4) **Observation:** Structural ambiguity is not sufficient to cause processing breakdown.

Garden path sentences such as (1) suggest that the parser is serial - that is, once facing a (local) ambiguity while parsing a sentence, the parser pursues just a single analysis of the sentence. In that case, there is no guarantee that the chosen analysis will turn out to be the correct one - thus, the parser will be required to reanalyze its initial analysis.¹

¹A parallel parser which fails to transition from an active analysis to an alternative analysis, or drops alternative analyses, may also account for the data described. For example, Gibson’s (1991) model ranks parallel structures according to a set of principles, and drops any structures which exceed a specified threshold. A garden path effect is accounted for if the correct structure turns out to be one that has been dropped.

Discussing alternative hypotheses according to which the parser is parallel is beyond the scope of this paper (see Crocker (1999) for a short discussion). For simplicity’s sake, I will regard the parser as purely serial, since the claims described in this paper apply in either case.

The garden path phenomenon raises interesting questions. Specifically, which analysis does the parser pursue when facing an ambiguous segment? Let us reconsider sentence (1). During processing, the parser faces the ambiguous segment in (2a). As stated above, the parser has two options to analyze the above segment. One option is to analyze *the clock* as the complement of the verb *mending*. In this case, if the final sentence turns out to be similar to (2b), no reanalysis would be required. Yet, if the final sentence has a similar structure to (2c), a reanalysis *will* be required. On the other hand, if the parser prefers to analyze *the clock* as the subject of a subsequent clause, then (2c) will not require reanalysis, while (2b) will.

As noted above, while (2b) does not cause any conscious parsing difficulty, (2c) does. We may thus assume that the parser initially pursues the analysis according to which *the clock* is the complement of the verb *mending*. Consequently, when the parser faces the remaining elements in (2c), it must reanalyze its initial structure and this results in a garden path effect. Crucially, this parsing choice is the one “made by humans uniformly in a variety of garden path sentences of diverse structural patterns” (Siloni (2004)). In fact, in spite of the (temporary) ambiguity, there is no optionality. In (2a), the human parser *systematically* first analyzes *the clock* as the argument of *mending*. Thus, human processing is systematic - and the underlying mechanisms that drive it will be later discussed. When the parser receives more words in (2c), a reanalysis will be required. In this case, the parser cannot reanalyze the sentence unconsciously, and thus the parser will face a processing breakdown.

Yet, not every reanalysis seems to result in a garden path effect. Consider the following sentences:

- (5) a. _{OK}John believed the man.
- b. _{OK}John believed the man cheated.
- c. _{OK}John believed that the man cheated.

All three sentences above are easy to process - that is, they do not cause a garden path effect. When the parser is faced with (5a), *the man* is analyzed as the complement of the verb *believed*. If the sentence ends at that point, no reanalysis is required. However, the sentence may continue as in (5b), where *the man* must be reanalyzed as the subject of the subsequent clause. Yet, this reanalysis does not result in a garden path effect. If we assume that the parser does commit some sort of reanalysis while parsing (5b), namely reanalyzing *the man* from a complement of the matrix verb to the subject of the subordinate clause, then we need to explain why this reanalysis does not result in a processing breakdown, while the one described for (1) does.²

²I regard a sentence as being a “garden path” sentence only if it requires a *conscious* reanalysis. That is, (5b) might be harder to process than its counterpart (5c) which includes the explicit complementizer *that*, leading perhaps to longer reading times that can be attested in psycholinguistic studies (e.g., Sturt, Pickering & Crocker (1999)). Yet, I will not regard (5b) as a garden path sentence, since it certainly does not result in processing breakdown and a conscious reanalysis.

To summarize, when forming a theory that accounts for processing sentences in general, and garden path sentences in particular, two main questions arise:

- (6) a. When facing an ambiguous segment, which analysis does the parser pursue?
- b. When a reanalysis is required, when will it result in a garden path effect?

In order to explain which sentences result in a garden path effect, one has to answer both questions in (6). Yet, despite the clear relation between them, distinguishing these two questions is important.³ Of course, the questions raised in (6) are only a subset of the questions one must answer when providing a full parsing theory. For instance, one should explain *when* a reanalysis is required. I will provide answers to many more questions in the subsequent chapters, but for now I would like to explicitly state the two questions above as the main questions that we will have to address.

Note that the garden path effect invoked by (1) can be avoided by means of adding a comma after the word *mending*, or by setting a context that makes it very clear that *mending* is intransitive. However, the interesting questions arise when the human parser operates “automatically”, that is, without clear cues such as punctuation marks or a specific context: Why, given no specific context, (2c) yields conscious parsing difficulty, whereas (2b) does not, given that neither includes punctuation marks.

Throughout this paper I will consider data from a wide range of languages. I rely on judgments that have been reported in the literature regarding specific sentences as to whether they induce a garden path effect. In some specific cases, where I have constructed the examples, I rely on judgments of native speakers (these cases are noted).

In the following sections, I will review various theories that have attempted to account for the questions posed in (6). I will discuss each in turn, and provide some counterexamples in order to demonstrate that the previous analyses are inadequate. I will then provide my own proposal.

3 Theta Attachment

One suggestion, aimed to answer question (6a) above, that is - which analysis the parser pursues when facing an ambiguous segment, is named Theta Attachment. This proposal was developed in Pritchett (1992), as part of Pritchett’s head-driven parser. In this section I will review this proposal. In section 4.1 I will also review other aspects of the parser described in Pritchett (1992).

In general, Pritchett (1992) claims that syntactic processing is driven by the grammar, specifically - by local application of grammatical principles. He suggests one main guideline that the parser employs, namely Theta Attachment, as defined below:

³This distinction has also been made in Pritchett (1992), Siloni (2004) and other works.

- (7) **Theta Attachment:** The theta criterion attempts to be satisfied at every point during processing given the maximal theta grid.
-Pritchett (1992), p.12 (23)

The “maximal theta grid” in this definition is the theta grid of the assigner, including optional theta-roles (if any). The theta criterion is the one defined as follows:

- (8) **Theta Criterion:** Each argument α appears in a chain containing a unique visible theta position \mathbf{P} , and each theta position \mathbf{P} is visible in a chain containing a unique argument α .
-Pritchett (1992), p.12 (24)

In order to satisfy the theta criterion, each argument must receive a θ -role, and each obligatory θ -role must be assigned. According to Theta Attachment, the parser is aware of the “maximal theta grid”, but the parser does not have to assign optional θ -roles.

3.1 Employing Theta Attachment

We shall now consider the processing of a simple sentence, (9), given a parser which employs Theta Attachment:

- (9) The man hugged Mary.

First, *the man* is encountered. At this point, it is probably structured as a DP (Pritchett (1992), fn.67), and kept in store. Note that the parser suggested by Pritchett (1992) is purely head-driven. That is, structure-building is considered to be derived by heads, which assign thematic roles to their arguments. Thus, TP is not projected before the head (in this case, the verb) has been encountered. Since *the man* is not a theta assigner, no theta roles can be assigned at this point of parsing, and thus no TP is projected.

Second, *hugged* is reached by the parser, given its lexical theta grid, which has two thematic roles - $\langle \theta_1, \theta_2 \rangle$.⁴ Since *hugged* is a theta assigner, and the parser strives to satisfy the theta criterion according to Theta Attachment, the parser is assumed to assign *hugged*'s θ_1 to the DP *the man*, and project the following structure:

⁴ θ_1 symbolizes the predicate's external thematic role, while θ_i ($i \neq 1$) refers to the predicate's internal thematic role(s).

(10)

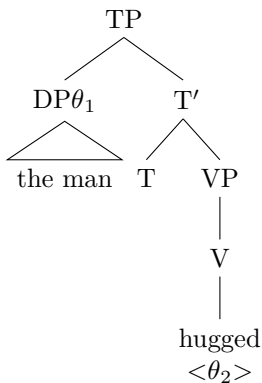

In the above structure, the theta role assignment is maximized given the already-parsed segment, *the man hugged* - as the argument *the man* receives a thematic role, and the predicate *hugged* - assigns it. If the parser doesn't assign the predicate's external thematic role to *the man*, then *the man* remains without a thematic role, and also the predicate remains with both of its thematic roles unassigned. Therefore, this would not maximize theta role assignment.

At this point, the parser encounters *Mary*. Since the predicate *hugged* may assign its internal thematic role to this argument, the parser will pursue this option which fully satisfies the theta criterion:

(11)

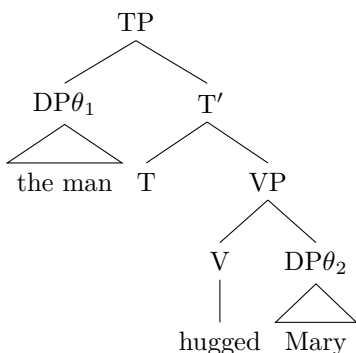

We shall now consider Theta Attachment with regards to a locally ambiguous sentence, (1) above, along with its parsing process (2), repeated here as (12):

- (12) a. While Mary was mending the clock
b. _{OK} While Mary was mending the clock it started chiming.
c. _{GP} While Mary was mending the clock started to chime.

Let us consider the process of parsing (12c) (which is identical to (1)), assuming Theta Attachment. At first, the parser encounters *While*, which is not a theta-assigner and is thus stored in the store. Similarly, upon encountering

Mary, the parser stores this DP in the store. Since the auxiliary *was* is also not a theta assigner, it is stored in the store as well. Finally, when the verb *mending* is reached, the parser builds an initial structure:

(13)

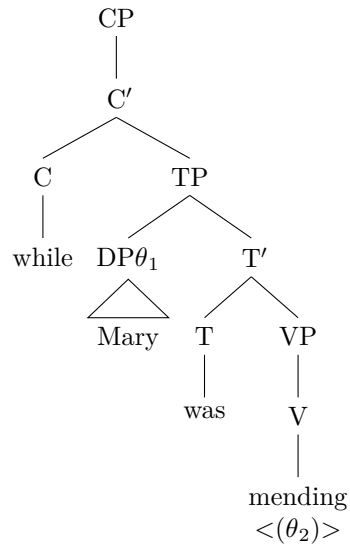

The parser has assigned the verb's external role, and *mending* is left with an unassigned (optional) internal role.

Now, when the the parser reaches *the clock*, it has reached the local ambiguity shown in (12). When facing the segment (12a), the parser may attach *the clock* as an argument of the verb *mending*, which might turn out correct in a sentence such as (12b). Alternatively, it may attach *the clock* as the subject of a consequent clause, as in (12c). Let us consider the two options more closely.

According to the first option, the parser attaches *the clock* as the complement of *mending*, and the following structure has been constructed:

(14)

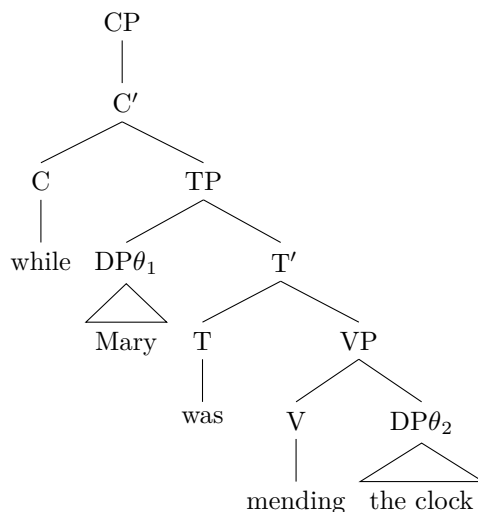

The parser has assigned *mending's* internal role to *the clock*. At this point, the theta criterion is fully satisfied - the predicate *mending* has assigned all of his thematic roles, and all arguments (*Mary*, *the clock*) have received thematic roles.

On the other hand, if the parser pursued the alternative parse, where *the clock* is considered to be the subject of a subsequent clause, then the parser has not yet reached a predicate which can assign a thematic role to *the clock*. Hence, the theta criterion is not maximally satisfied, as *the clock* is an argument which lacks a thematic role.

In summary, while parsing *the clock* as a complement of *mending* fully satisfies the theta criterion, parsing it as a subject of a subsequent clause - does not. As the theta criterion attempts to be satisfied at every point during processing according to Theta Attachment, the parser is liable to *constantly* prefer the analysis where *the clock* is a complement of the main verb. This prediction is consistent with the data regarding this example - since (12c) is a garden path sentence, we may assume that the parser initially pursues the structure where *the clock* is a complement of the main verb when facing the locally ambiguous segment (12a), and later performs reanalysis in order to achieve the structure that is compatible with (12c).

In the above example, Theta Attachment was helpful in explaining the data regarding garden path sentences which consist of Object/Subject ambiguities. Let us consider another example, taken from Crain & Steedman (1985):

(15) _{GP}John told the man that Mary kissed that Bill saw Phil.

The sentence above can be rephrased as: "The man that Mary kissed was told by John that Bill saw Phil". Let us consider how a parser employing Theta Attachment would process it.

At first, *John* is encountered. As in previous examples, since the parser cannot assign any thematic roles at this point, *John* is sent to the store. When the parser encounters the matrix verb *told*, an initial structure can be built - where *told*'s external theta role is assigned to *John*, as follows:

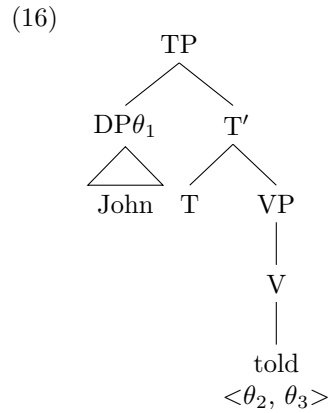

At this point, *told* still has two unassigned thematic roles. When *the man* is encountered, the parser must assign the verb's second thematic role in order to comply with Theta Attachment:

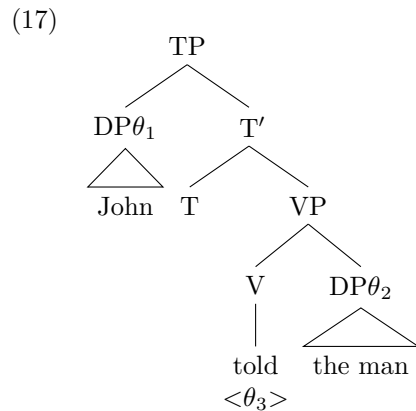

At this point in parsing, the parser encounters *that*, and saves it in the store as it cannot assign a theta role. The parser also keeps *Mary* in the store once it's encountered, and by the time *kissed* is reached, the parser assigns *kissed*'s external theta role to *Mary*, and a CP can be constructed. At this point, the parser has two options:

On one hand, it may assign the newly constructed CP, $CP[\text{that Mary kissed}]$, the third theta role of *told*, yielding the following structure:

(18)

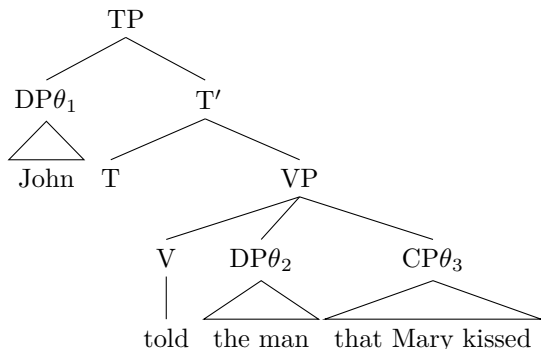

Since *kissed* can also appear without an internal complement, the above option fully satisfies the theta criterion. Specifically, *told* has assigned all of his theta roles, and no argument is left without a thematic role assigned.

On the other hand, the parser could pursue a structure where the CP, CP [that Mary kissed], is adjoined as a relative clause to DP [the man]:

(19)

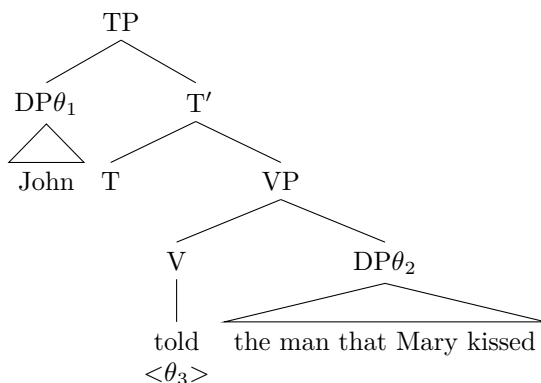

Under this analysis, the theta criterion is not maximally satisfied, as *told* remains with an unassigned thematic role. Consequently, the first option, where the parser assigns the matrix verb's third thematic role to the subordinate CP, is preferred according to Theta Attachment. Since the structure corresponding to this option is incompatible with the end of sentence (15), a reanalysis is required and a garden path effect is attested. Thus, Theta Attachment is also compatible with the data regarding this kind of garden path sentences, namely sentences which contain a sentential complement / relative clause ambiguity.

Note that Theta Attachment is incremental, in that the parser does not wait until the end of the sentence before constructing a structure. Yet, Theta Attachment is not *strictly* incremental, since it allows the parser to store elements until they receive a θ -role. We shall further discuss this issue in section 5.

3.2 Optional garden path sentences

So far, we have seen how Theta Attachment accounts for reanalysis in two different types of garden path patterns that consistently lead to breakdown. Yet, there are sentences which yield a garden path effect only for some human parsers. Let us consider the difference between the following sentences:

- (20) a. _{GP}The boat floated down the river sank.
 -Bever (1970)
 b. _{GP/OK}The bear recently found disappeared.
 -Siloni (2004)

Although (20a) and (20b) seem to have a similar structure, (20a) consistently yields a garden path effect, while (20b) only for some speakers. Let us first consider (20a). When the parser reaches *floated*, it has two options. The first is to regard *floated* as an intransitive verb, assigning its external role to *the boat*. In this case, the theta criterion is fully satisfied:

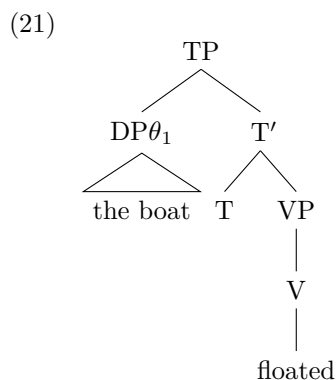

The other option is to regard *floated* as the passive instantiation (of the transitive *float*) heading a reduced relative (meaning “the boat that was floated”), and assigning its internal thematic role to the relative operator. The newly constructed argument DP [the boat floated] is not assigned a θ -role, and therefore the theta criterion is not maximally satisfied.

Hence, complying with Theta Attachment, the parser must choose the first option, according to which *floated* is an intransitive verb. Next, the PP *down the river* is encountered and added within VP. Upon the appearance of *sank*, the processing path is revealed to be incorrect and thus a reanalysis is required.

Let us now consider the distinction between (20a) and (20b) above. While *floated* has both an intransitive and a transitive realizations, *found* does not have an intransitive realization. Consequently, when the parser reaches *found* in (20b), with its theta grid $\langle \theta_1, \theta_2 \rangle$, it has two alternative options: It can either regard *found* as an active matrix verb assigning its thematic role to *the bear*, or regard it as a passive verb, yielding DP [the bear recently found] (cf. the bear that was recently found). This time, the two options are identical in regard

to the satisfaction of the theta criterion. In the first option, *found* remains with an obligatory internal role to assign. In the second option, *found* has assigned both of its theta roles (since it is passive, the external role is implicit and the second is assigned), yet the argument DP [the bear recently found] lacks a theta role. Hence, both options are equal with regard to the satisfaction of the theta criterion,⁵ and thus Theta Attachment does not prefer one of them over the other.

In these cases, Pritchett (1992) assumes that the parser randomly picks one of the options and pursues with it. If the parser pursues an analysis in which *found* is active, reanalysis will be required, yielding a garden path effect. If, however, the parser randomly picks out the second alternative, where *found* is in the passive voice, then the sentence is compatible with this analysis and no reanalysis is necessary.

3.3 Issues with Theta Attachment

So far we have demonstrated that the predictions made by Theta Attachment are borne out in many cases. Now, we shall examine a case where its predictions turn out to be wrong.

In order to understand this case, I will start with a short introduction about a relevant orthographic phenomenon. Heterophonic homographs are words that are written the same but sound differently. Consider, for instance, the word *dove* in the following sentences, taken from Szterman & Friedmann (2014):

- (22) a. OK We saw a dove flying in the sky.
 b. OK The dolphin dove into the river.

Even though *dove* is written exactly the same in both strings in (22), in (22a) it appears as a noun whereas in (22b) it appears as a verb. Therefore, the word is read out differently. Despite the ambiguity of the string *dove*, neither of the sentences above yield a processing breakdown - the parser can automatically pick the correct reading.

In Hebrew orthography, not all vowels are represented, some consonant letters are phonologically ambiguous, and the stress position is not marked (Friedmann and Lukov (2008)). These characteristics create many heterophonic homographs, and for many of them one reading is a noun and the other is a verb. Some studies have exploited these features of Hebrew (e.g., Szterman & Friedmann (2014)), but I am not aware of studies that used them in order to construct garden path sentences. The sentence below has been reported by several native Hebrew speakers to induce a garden path effect:

- (23) CP bi-zman še-ra'iti yeled ŠOVR higi'a b-a-do'ar.
 in-time that-I.saw boy coupon/breaking arrived in-the-mail
 'When I saw a boy, a coupon arrived in the mail.'

⁵As explicitly stated by Siloni (2004), and further discussed in sections 4.3 and 6.1 of the current paper, an unassigned role "equals" an unattached argument.

The word ŠOVR is written in a way that resembles the Hebrew orthography (as it includes the first vowel and omits the second one). Let us consider the processing of (23). Before encountering the word ŠOVR, the parser constructs the structure below:⁶

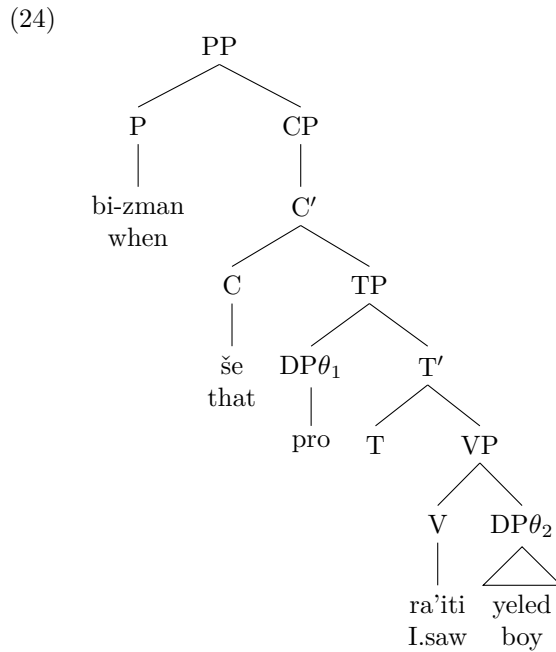

'When I saw a boy...'

Next, the parser encounters ŠOVR, which can be read either as šover (breaking) or šovar (a coupon). In case the parser chooses the *breaking* reading, the yielded meaning is “when I saw a boy breaking...”. In this case, *breaking* remains with an obligatory internal role to assign. In case the parser interprets ŠOVR as *a coupon*, the latter is an argument lacking a thematic role. Therefore, the two options are equal with regards to Theta Attachment, and Pritchett’s (1992) theory predicts the parser to randomly pick one of the options, as explained in section 3.2. Of course, only interpreting ŠOVR as *a coupon* is compatible with the continuation in (23). Thus, Theta Attachment predicts that reanalysis will occur in about half of the times. However, this sentence seems to consistently lead to a processing breakdown, suggesting that the parser systematically picks the *breaking* reading, despite having no clear preference from the Theta Attachment’s perspective.

Notice that (23) is still ambiguous upon encountering ŠOVR. That is, the *breaking* reading of ŠOVR may be the correct one in some sentences, such as (25) below:

⁶In Modern Hebrew, verb movement from V to T is attested. I omit it from (23) for simplicity’s sake.

- (25) OKbi-zman še-ra'iti yeled ŠOVR xalon mixtav higi'a
 in-time that-I.saw boy coupon/breaking window letter arrived
 b-a-do'ar.
 in-the-mail
 'When I saw a boy breaking a window, a coupon arrived in the mail.'

The strings in (23) and (25) are identical up to ŠOVR. Again, a parser employing only Theta Attachment does not prefer either reading of ŠOVR over the other. Yet, only the *breaking* reading is compatible with (25). Since this sentence is consistently reported to be easy to process, it seems that the parser systematically pursues the *breaking* reading,⁷ contradictory to Theta Attachment's predictions.

In summary, while Theta Attachment predicts both (23) and (25) to be optional garden path sentences, (23) consistently yields a garden path effect whereas (25) is easy to process. I will discuss additional issues with Theta Attachment in section 5.1, where I consider the incremental nature of the human parser.

3.4 Interim Summary

In section 2, I have reviewed the phenomenon of garden path and raised two main questions regarding it in (6), repeated here as (26):

- (26) a. When facing an ambiguous segment, which analysis does the parser pursue?
 b. When a reanalysis is required, when will it result in a garden path effect?

In this section, I have reviewed the Theta Attachment principle suggested by Pritchett (1992), as a possible explanation for (26a). I have reviewed its definition, and then provided a few sentences as examples where a parser employing Theta Attachment predicts reanalysis in cases where garden path effects are attested. In subsection 3.2, I have demonstrated how Theta Attachment can also predict cases where a sentence yields a garden path effect only on chance - that is, in about half of the times.

For now, I shall adopt Theta Attachment. However, as shown in section 3.3 and later in section 5.1, Theta Attachment is unable to account for some of the data attested in the literature, and should thus be extended or revised.⁸ I will thus adopt a different mechanism in section 6.1.

Now, let us try to answer the question posed in (26b).

⁷This preference should not be counted as a general preference towards a verb reading in verb-noun ambiguities in Hebrew. The Hebrew sentence (108) discussed in section 4.3.2 demonstrates a case where the noun reading is preferred over the verb reading, which leads to a garden path effect.

⁸For another thorough discussion regarding Theta Attachment, see Sadeh-Leicht (2007).

4 Review of current suggestions regarding re-analysis

This section critically reviews previous proposals as to question (6b), namely what type of reanalysis will result in a garden path effect. For that, I shall review various proposals that have been suggested in the literature, and point to cases where each proposal fails to account for the data.

4.1 Pritchett (1992) - OLLC and rebuffering

In addition to proposing Theta Attachment, Pritchett (1992) also suggests a constraint on reanalysis:

- (27) **On-Line Locality Constraint (OLLC)**: The target position (if any) assumed by a constituent must be governed or dominated by its source position (if any), otherwise attachment is impossible for the automatic Human Sentence Processor.
-Pritchett (1992) p.101, (286)

Pritchett (1992) does not explicitly define *target position* or *source position*. Government is defined below:

- (28) **Government**: α governs β iff α m-commands β , and every γ dominating β dominates α , γ a maximal projection. (Adapted from Chomsky (1986a))
-Pritchett (1992), fn.101
- (29) **M-command**: α m-commands β iff α does not dominate β and every γ that dominates α dominates β , γ a maximal projection. (Adapted from Chomsky (1986a))
-Pritchett (1992), fn.101

We can break down the OLLC into two conditions - that is, for a reanalysis not to result in a garden path effect, the target position must be either (i) dominated by its source position; or (ii) governed by its source position. We shall consider each of these conditions in turn.

4.1.1 Dominance

To see how the dominance clause of the OLLC might be relevant, consider (5a) and (5b), repeated here as (30a) and (30b), respectively:

- (30) a. OK John believed the man.
b. OK John believed the man cheated.

Neither of the sentences presented in (30) cause a garden path effect, yet - assuming Theta Attachment, the processing of (30b) involves reanalysis. Let us consider the parsing of (30a). Upon encountering the verb *believed*, the parser is able to construct an initial structure:

(31)

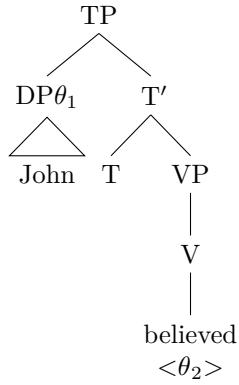

Once the parser encounters *the man*, it is able to assign it its internal thematic role, thus satisfying the theta criterion. The built structure is thus:

(32)

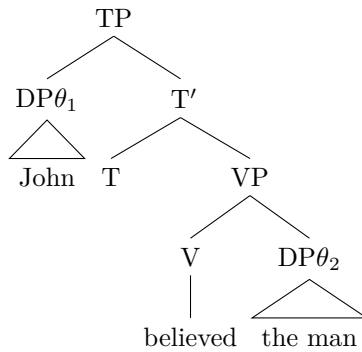

Yet, upon reaching *cheated*, it is apparent that the previous analysis is incorrect - and *the man* is not the complement of *believed*. Rather, it is the subject of a subsequent clause - *CP*[the man cheated]. I will follow the notation used in Siloni (2004), and use a frame to mark the source position and a bolded frame to indicate the target position following reanalysis:

(33)

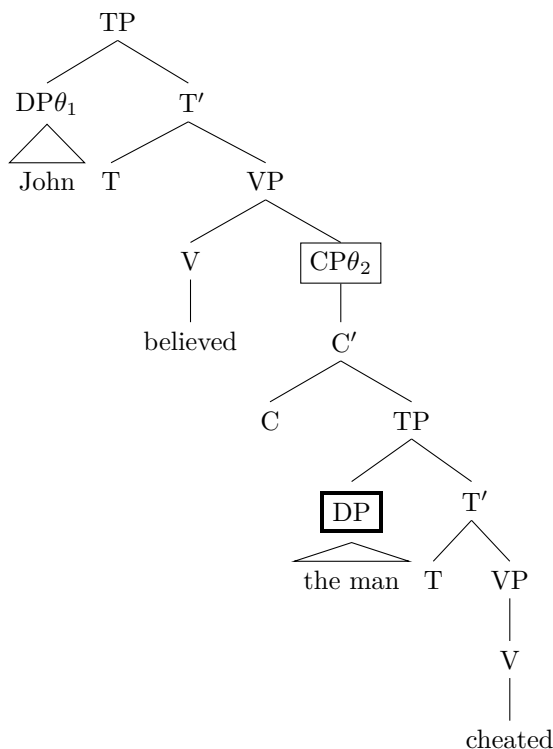

As can be seen, the source position (namely, the position of the direct object of *believed*) dominates the target position (namely, the subject of the sentential complement). Thus, the OLLC correctly predicts that this reanalysis will not cause a garden path effect.

Now, consider the difference between (30b), repeated below as (34a), and the garden path sentence (34b):

- (34) a. _{OK}John believed the man cheated.
b. _{GP}John warned the man cheated.

The two sentences in (34) above are very similar, and differ (linearly) only in the matrix verb. Since we have already described the parsing process for (34a), we shall now consider the processing of (34b). At first, the parser stores *John* in the store. Then, when *warned* is encountered, the parser assigns its external role to *John*. Note that *warned* has three thematic roles (including an optional one) - $\langle \theta_1, (\theta_2), \theta_3 \rangle$, as opposed to *believed*, which has only two.

(35)

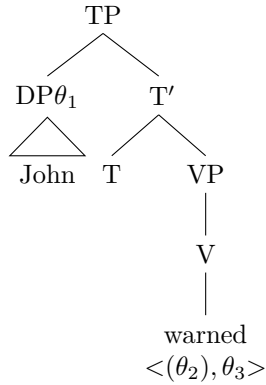

As the parser encounters *the man*, it is assigned a thematic role, complying with Theta Attachment. In this meaning, John has warned the man about something, that the parser is yet to encounter.

(36)

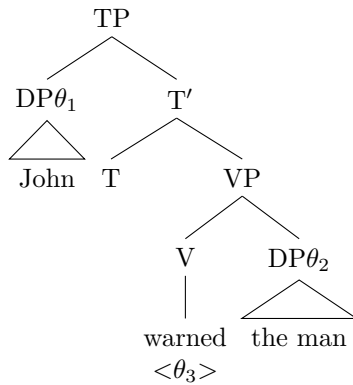

When the parser encounters *cheated*, the previous analysis turns out to be wrong. Furthermore, a reanalysis cannot create a sentential complement as the first complement of *warned*, as this complement receives the thematic role corresponding to the person being warned. That is, *the man* must be reanalyzed as the subject of the clause which is assigned θ_3 , namely the clause expressing the content of the warning.

(37)

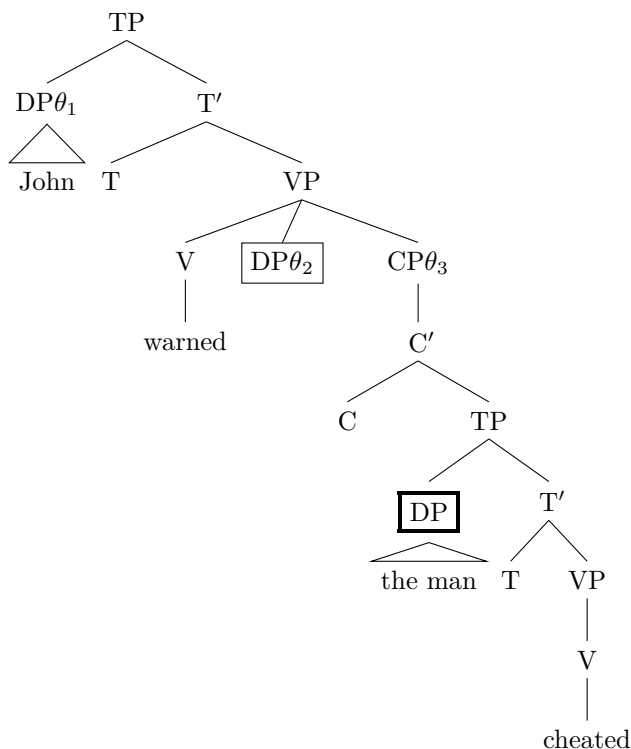

Crucially, unlike the reanalysis that took place during the processing of (34a), where the source position dominated the target position, here it does not.⁹ The source position, namely the first complement of the verb *warned*, does not dominate the subject position of its second complement. The target position is also not governed by the source position, due to the existence of barriers between them. This reanalysis is “impossible for the automatic Human Sentence Processor” according to the OLLC. Thus, the OLLC correctly predicts that while (34a) does not lead to a garden path effect, (34b) does.

4.1.2 Government

Now, let us consider the second condition of the OLLC - namely, that it is also sufficient for the source position to govern the target position for a reanalysis to occur without processing breakdown.

Consider the following two sentences, from Pritchett (1992):

(38) a. \circ_K They gave her books.

⁹Since *warned* has two internal arguments, and CP is interpreted as the second internal argument (as in the sentence *John warned the man that they cheated*), Pritchett (1992) assumes that CP occupies a new branch, rather than the same branch that DP[the man] has occupied in (36).

b. _{OK}They gave her books to Ron.

Neither of the above sentences causes a garden path effect. Let us consider the process of parsing (38a). Upon encountering *They*, the parser stores it. When it encounters *gave*, the parser assigns its external theta role to *They*.

(39)

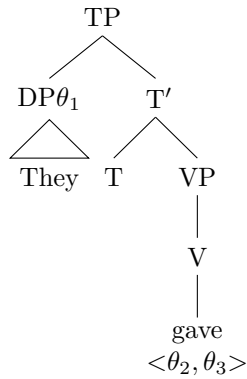

When the parser encounters *her*, it assigns it *gave*'s goal role. Under Theta Attachment, the parser will do so, in order to maximally satisfy the theta criterion.

(40)

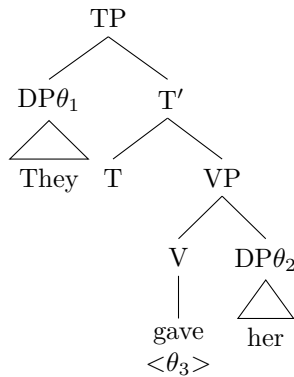

Now, the parser encounters *books*, and assigns it *gave*'s second internal role, namely the *theme* thematic role. This satisfies the theta criterion.

(41)

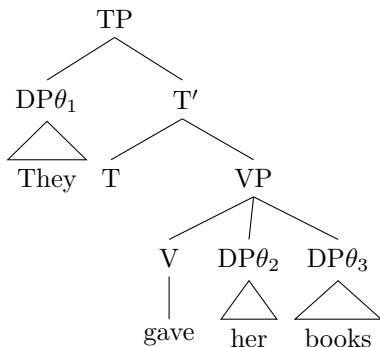

This achieves a grammatical parsing for (38a), and ends the parsing if the sentence ends. However, the sentence may continue, as in (38b). When the parser reaches *to Ron*, the initial analysis must be revised, as *to Ron* must receive a theta role. The reanalysis results in the following structure:

(42)

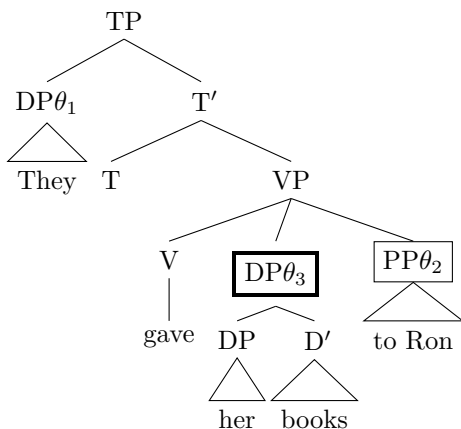

One thing that would be interesting to note here, is that a switch of theta roles does not cause a garden path effect. That is, before reanalysis, the first internal argument of *gave* had received a *goal* role, yet after the reanalysis - it received a *theme* role. Since (38b) does not yield a garden path effect, we can conclude that switching of thematic roles on its own does not result in a garden path effect.

(43) **Observation:** Switching of thematic roles on its own does not result in processing breakdown.

Moreover, note that the source position does not dominate the target position. However, the source position does govern the target position, and thus the OLLC predicts that this reanalysis is possible for the “automatic Human Sentence Processor”, thus accounting for the fact that this sentence does not result in a processing breakdown.

4.1.3 Rebuffering

In addition to Theta Attachment and the OLLC, discussed in sections 3 and 4.1, Pritchett's (1992) theory also includes a mechanism of determining when storing is licit. This mechanism is required in order to account for sentences that do not cause processing breakdown, even though they seem to violate the OLLC. Mulders (2002) refers to this mechanism as *rebuffering*, a term that I shall adopt.

In order to demonstrate the need for the rebuffering mechanism, consider the contrast between the two following sentences, taken from Pritchett (1992):

- (44) a. _{GP/OK}The spaceship destroyed disintegrated.
 b. _{OK}The spaceship destroyed in the battle disintegrated.

Let us first consider (44a). Upon arrival of *the spaceship*, the parser stores it. Upon *destroyed*, the parser faces two equal routes: on one hand, the parser can place *destroyed* as an active verb, assigning its external thematic role to *the spaceship*. In this case, the internal thematic role of *destroyed* has not been assigned. On the other hand, the parser may choose to interpret *destroyed* in the passive voice, and construct _{DP}[the spaceship destroyed] (that is, the spaceship that was destroyed). Under this analysis, this entire DP is left without a theta role. Therefore, either option may be chosen according to Theta Attachment, and (44a) resembles the cases described in section (3.2). Let us consider the case under which the parser pursues the analysis where *destroyed* is taken to be an active verb, and constructs the following structure:

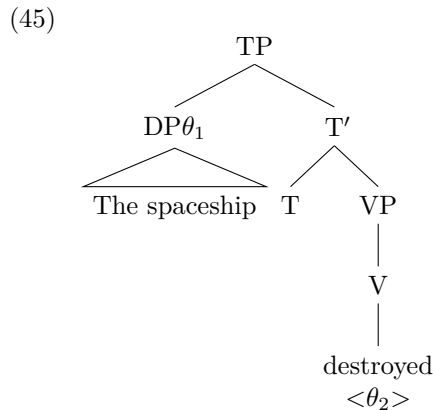

Yet, when *disintegrated* is reached, the above analysis is proven incorrect and must be revised, as *disintegrated* is a predicate that cannot be attached to the structure. The newly constructed structure is as follows:

(46)

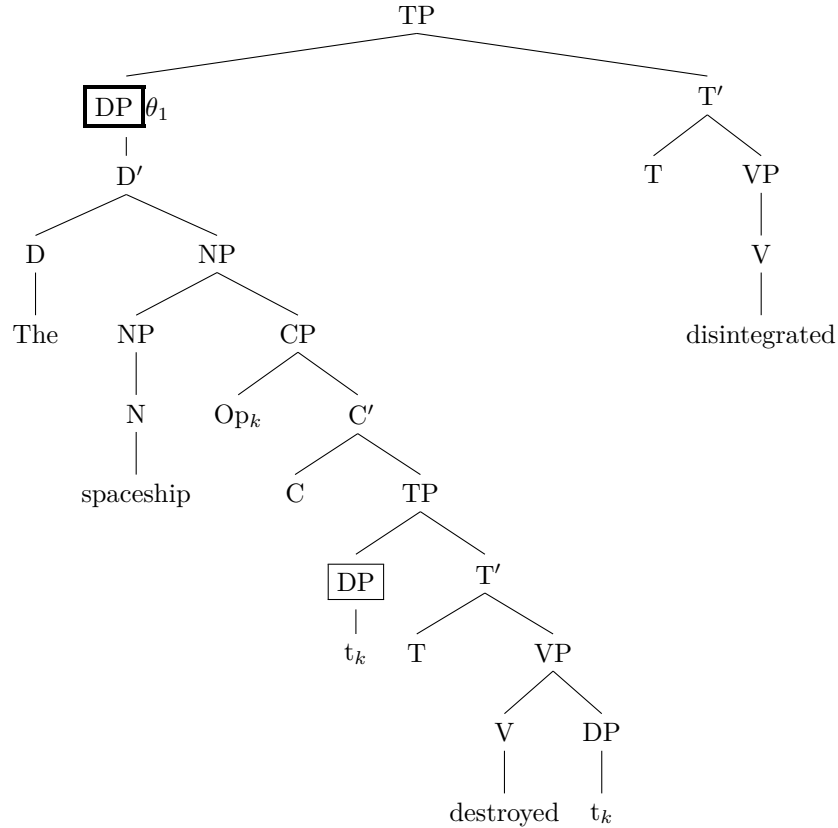

The source position neither dominates nor governs the target position, and a garden path effect is correctly predicted by the OLLC.

Why, then, doesn't (44b) yield a garden path effect? Let us consider the parsing process of this sentence. Up to the point that the parser reaches *destroyed*, this sentence is identical to (44a). Thus, we assume that in some cases the parser pursues the analysis described above, in (45). Now, in contrast to (44a), the parser encounters the PP *in the battle*. Pritchett (1992) suggests that in this point of processing, the need of performing reanalysis is revealed. The need to reanalyze the sentence is clear, since English imposes an *adjacency requirement* between the verb and its accusative complement (Stowell (1981)). As Pritchett (1992) states, in English, "a nominal complement must occur right adjacent to its verb, unseparated from it by other arguments or adjuncts". This results in the ungrammaticality of (47) below.

- (47) *The spaceship destroyed in the battle the planet.
-Pritchett (1992), (271)

According to Pritchett (1992), due to the *adjacency requirement*, the PP [in the battle] makes the parser "understand" the need for reanalysis - namely,

attaching *destroyed in the battle* as a reduced relative modifying *the spaceship*. However, since the PP is *not* a theta assigner, this whole DP [the spaceship destroyed in the battle] cannot be placed into the structure, as its theta role assigner has not been encountered. That is, this DP must wait in store until the arrival of its theta assigner.

According to Pritchett (1992), this kind of reanalysis, that is enforced by a non-theta assigner and involves rebuffering, is not problematic for the human parser - that is, it does not yield a garden path effect. As Mulders (2002) explains, rebuffering can never violate the OLLC, “because if material is sent back to store, there is no target position, and hence the OLLC does not apply”. In (44b), when the matrix verb *disintegrated* is encountered at last, the parser can use the elements in the store in order to construct the correct structure, and finish the processing of the sentence without difficulty.

Note, as Siloni (2004) explains, that rebuffering is not a device that can freely be used to avoid breakdown. Employing Theta Attachment, the parser strives to merge elements to the structure as soon as possible. Yet, rebuffering “is unavoidable and therefore allowed, only if the target position is not yet available”. These cases arise only when the reanalysis is triggered by a non theta role assigner, such as the PP *in the battle* in (44b), which proves the initial analysis to be incorrect due to the *adjacency requirement*.¹⁰ Mulders (2002) summarizes the rebuffering mechanism as follows:

- (48) **Rebuffering:** When the Human Sentence Processor encounters a non-theta-assigning element that disproves the analysis made so far, the structure is broken up; the elements that cannot be attached, are put back in the buffer.

-Mulders (2002), Chapter 4, (6)

4.1.4 Issues with Pritchett’s (1992) theory

Although the OLLC and rebuffering mechanism can account for many types of garden path sentences, as well as sentences that do not result in garden path effect, they make wrong predictions in some cases. Below I present an example Pritchett’s (1992) proposal erroneously predicts to yield a garden path effect, as well as a garden path example it predicts to cause no breakdown.

Consider the following Japanese example, taken from Mazuka & Itoh (1995) (9c):

¹⁰The adjacency requirement has an exception in *Heavy NP-Shift constructions*. That is, intervention between the verb and its accusative argument is allowed when the latter is phonetically heavy. Consider the following example, taken from Pritchett (1992) (273):

- (1) The spaceship destroyed in the battle the giant Kzinti cruiser which had been pursuing it for weeks.

According to Pritchett (1992), this kind of sentences does not pose processing difficulty since the parser can build the structure using all the elements from the buffer, once all the sentence has been encountered. See Pritchett (1992) for a full account.

- (49) OK Nakamura-ga tyuuko-no pasokon-o katta toki
 Nakamura-NOM second-hand PC-ACC bought when
 syuuri-site-kureta.
 repaired(for-me)
 'Nakamura_i, when (I_j) bought a second-hand PC, repaired (it) for me_j'

We shall now consider the processing of (49). At first, when the parser encounters *Nakamura* and sends it to the store. It similarly sends *second-hand PC* to the store. When *bought* is encountered, the parser builds an initial clause - '*Nakamura bought a second-hand PC*'. Then, *when* is encountered, so a *CP* is constructed as follows:

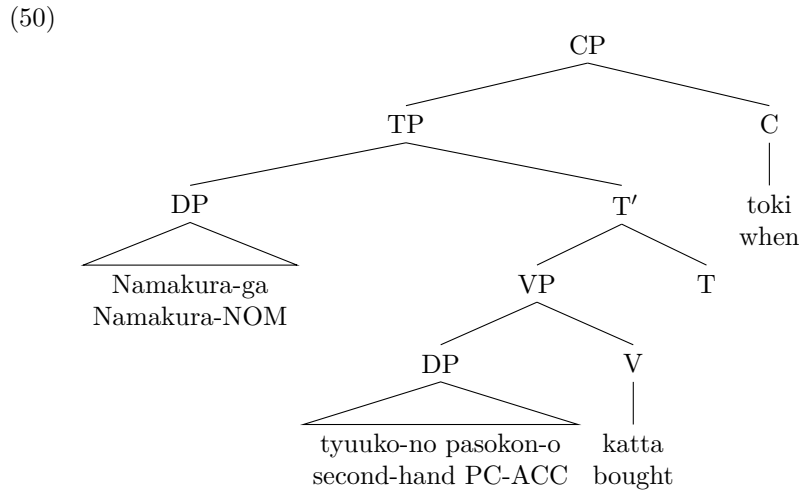

'When Nakamura bought a second-hand PC'

At this point during parsing, the parser encounters *repaired (for-me)*, In Japanese - *syuuri-site-kureta*. Due to the morpheme *kureta*, it “becomes apparent that Nakamura is the subject of the matrix verb and the subject of the embedded verb must be the speaker” (Mazuka & Itoh (1995)).¹¹ Therefore, the parser must perform the following reanalysis:

¹¹As Mazuka & Itoh (1995) explain, in Japanese, there are verbs of giving and receiving, “the choice of which depends on whether the beneficiary/benefactor is the speaker or the third person”. Importantly, *kureru* is only used when the receiver is the speaker (or in the speaker’s group). When it is used as an independent verb, it means ‘give it to me’. Yet, when it is used in a compound verb, as in (49), it means that ‘somebody did something for my benefit’.

(51)

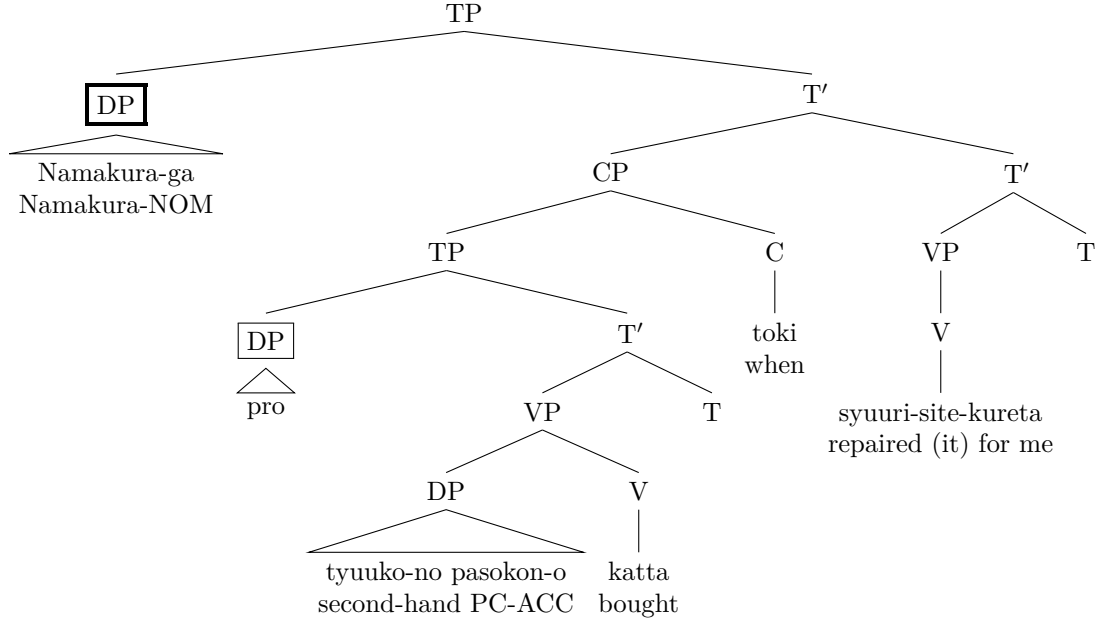

'Nakamura_i, when (I_j) bought a second-hand PC, repaired (it) for me_j.'

Nakamura has been relocated from the subject position of the adjunct to the subject position of the matrix clause. The source position neither governs nor dominates the target position. Thus, the OLLC predicts that this reanalysis will be impossible for the parser, and yield a garden path effect. However, as Mazuka & Itoh (1995) note, "this type of reanalysis does not result in a garden-path effect", contradictory to the OLLC's prediction.

Now, let us consider another Japanese example, taken from Mazuka & Itoh (1995) (14a):

- (52) _{GP}Yoko-ga kodomo-o koosaten-de mikaketa takusii-ni noseta.
Yoko-NOM child-ACC intersection-LOC saw taxi-DAT put-on
'Yoko put the child on the taxi she saw at the intersection.'

As Mulders (2002) notes, this sentence is incompatible with the theory described in Pritchett (1992). Let us consider the parsing of this sentence. First, the parser encounters *Yoko*, and sends it to the store. Same applies for *the child* and *the intersection*, as they all need to receive a theta role in order to be attached to the structure. Then, when the verb *saw* is encountered, the following structure can be built:

(53)

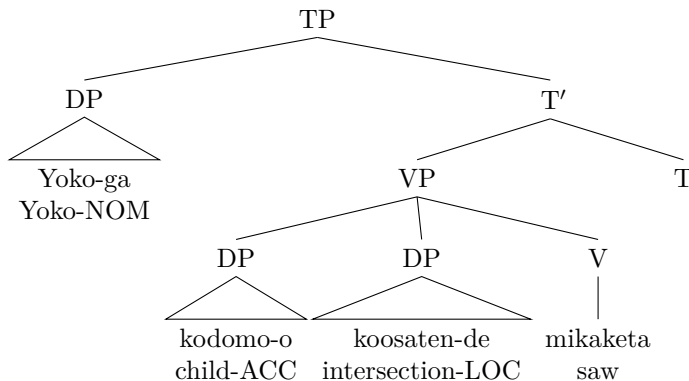

'Yoko saw the child at the intersection.'

The above structure describes a grammatical matrix clause, and the sentence might have ended that way. However, at this point of processing, the parser encounters the non theta-assigner, *taxi*. This DP makes it clear that the above structure is incompatible with the sentence, and should be reanalyzed - namely, changing the original matrix clause to a relative clause.¹² Since *taxi* cannot be assigned the external thematic role of *saw* (as *saw* takes an animate argument for its external thematic role), the relative clause is an object relative - that is, 'the taxi that she saw at the intersection'¹³ (since there is no subject available for the relative clause, a *pro* is inserted as the subject).

As a result, the reanalysis at this points yields three distinct DP elements - *Yoko*, *the child*, and *the taxi she saw at the intersection*. Since no theta assigner for either of these elements has been encountered, the rebuffering mechanism must be used, sending these elements to the store. At this point, the store should include these elements as follows:

¹²Inoue (1990) reports empirical evidence showing that a slowdown occurs when encountering a noun (e.g., *taxi*) following the verb. Inui et al. (1998) report related fMRI data.

¹³It is impossible to achieve 'the child that she saw at the intersection', as in Japanese the relative clause precedes its modified noun phrase.

(54)

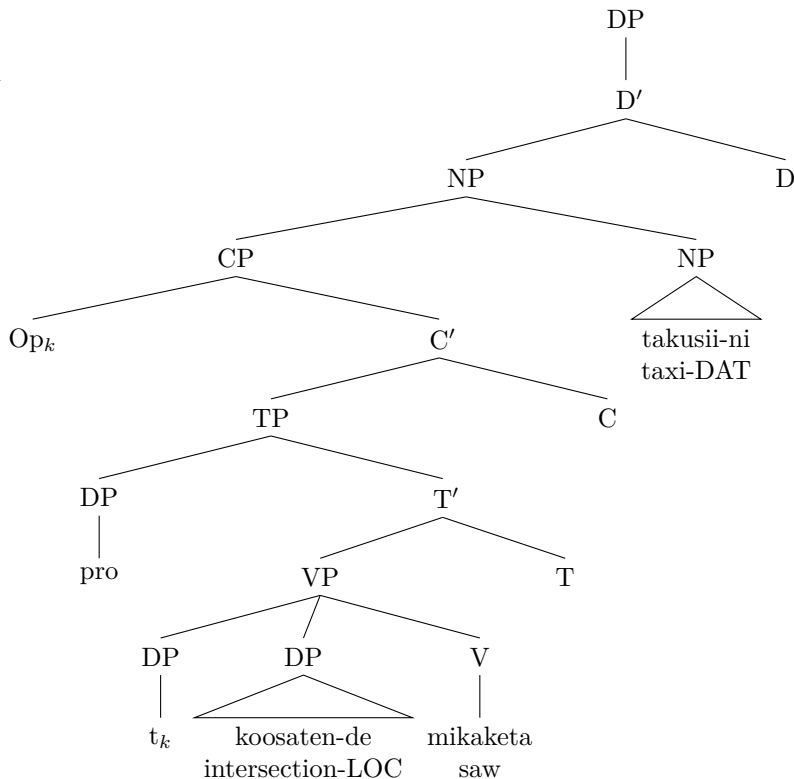
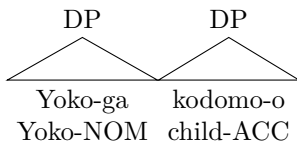

'Yoko; the child; the taxi she saw at the intersection.'

Now, when the parser encounters the matrix verb, *put-on*, the parser should be able to place all the arguments from within the store into the structure, and the sentence should be parsed without difficulty. However, as mentioned above, this sentence yields a processing breakdown, contradictory to the theory described by Pritchett (1992).¹⁴

Consider now the contrast between (20a) repeated as (55a) and (44b) repeated as (55b):

- (55) a. _{GP}The boat floated down the river sank.
 -Bever (1970)
 b. _{OK}The spaceship destroyed in the battle disintegrated.
 -Pritchett (1992)

¹⁴Tokimoto (2004) also reports a garden-path effect regarding other sentences with the same construction, such as:

- (1) _{GP}Jiro-ga roopu-o kitta maruta-ni shikkari makitsuketa.
 Jiro-NOM rope-ACC cut log-DAT tightly wound
 'Jiro tightly wound a rope around a log he had cut.'

As explained in section 3.2, according to Theta Attachment the parser pursues the active reading of *floated* in (55a). The subsequent PP [down the river] is attached to the VP when encountered. Upon the appearance of *sank*, the processing path is revealed to be incorrect and thus a reanalysis is required.

In section 4.1.3, I explained that according to Theta Attachment the parser will sometimes pursue the active (transitive) reading of *destroyed* in (55b). Yet, upon encountering the PP [in the battle], the parser performs reanalysis, prior to the occurrence of the matrix verb. This reanalysis relies on the rebuffering mechanism, and thus (55b) yields no garden path effect.

According to Pritchett (1992), the main difference between the sentences in (55) relies on the first verb. Specifically, *destroyed* is obligatorily transitive, *floated* has both intransitive and transitive realizations.¹⁵ We would then expect that any verb with an optional intransitive realization will cause a processing breakdown, in case it turns out to be the verb of a reduced relative. This prediction turns out to be wrong in some cases, such as the following sentence from Stevenson & Merlo (1997):

(56) OK The butter melted in the microwave was lumpy.

Note that the rebuffering mechanism cannot operate while parsing (56), as *the butter melted in the microwave* is a grammatical matrix clause. Thus, Pritchett's (1992) theory wrongly predicts (56) to induce a garden path effect just like sentence (55a).

Stevenson & Merlo (1997) claim that the difference between (55a) and (56) stems from the distinction between unaccusative verbs (e.g., *melted*) and unergative verbs (e.g., *raced*). On the other hand, Filip (1998) provides examples of sentences with reduced relatives headed by transitive alternates of unaccusative verbs, that are harder to process than some sentences with reduced relatives based on transitive alternates of unergatives. Providing a full account for processing of reduced relatives is beyond the scope of the current paper.¹⁶

In summary, we have seen examples which the OLLC predicts to yield a garden path effect, yet are easily processed. We have also seen a garden path sentence that Pritchett's (1992) theory, and specifically the rebuffering mechanism, predict to be processed without difficulty. With this in mind, we shall now consider other theories which aim to account for the garden path phenomenon.

4.2 Structural Determinism

Another theory that aims to account for parsing phenomena in general, and garden path in particular, is called Structural Determinism. It is based on Description-Theory (henceforth: "D-theory") developed by Marcus et al. (1983), and further developed by Gorrell (1995) and later by Sturt & Crocker (1996).

¹⁵Gibson (1991) has also claimed that the optional transitivity of the first verb causes the difficulty in sentences such as (55a).

¹⁶See also Grove (2011) regarding processing of reduced relatives, and specifically the distinction between unergative and unaccusative verbs. See Mulders (2002) for a discussion of reduced relatives in Dutch.

4.2.1 Determinism

One of the first researches leading to D-theory is the parser described by Marcus (1980). One of the core concepts of this parser is the *Determinism Hypothesis* provided below.

- (57) **Determinism Hypothesis:** The syntax of any natural language can be parsed by a mechanism which operates "strictly deterministically" in that it does not simulate a nondeterministic machine.
-Marcus (1980)

As Gorrell (1995) explains, a parse is "strictly deterministic" if "all the structure created by the parser in the parse sequence is part of the final output." In other words, the parser cannot prune nodes from the tree. Nor can it remove feature specifications from nodes, or alter the attachment site for a node. In addition, for the parse to be "strictly deterministic", it cannot proceed in parallel, abandoning structure as it proves incompatible with subsequent input. Marcus (1980) claims that all sentences that are parsed without conscious difficulty, that is, non-garden path sentences, can be parsed strictly deterministically.

In order to account for ambiguous input, the parser suggested by Marcus (1980) includes a "lookahead" buffer, which delays the analysis of ambiguous material until a limited amount of additional input has been processed. Yet, empirical evidence suggests that the human parser has no such "lookahead" buffer (for discussion of this issue, see Gorrell (1995) section 3.3). Consequently, Marcus et al. (1983) have modified the parser proposed in Marcus (1980) so that, instead of computing a *structural representation* during the process of parsing, the parser rather computes a *description* of a structural representation. Their description relies on dominance, and the fact that dominance is a transitive relation. That is, if node α dominates node β , and node β dominates node γ , then node α dominates node γ , as demonstrated in (58) below.

(58)

$$\begin{array}{c} \alpha \\ | \\ \beta \\ | \\ \gamma \end{array}$$

Since dominance is a transitive relation, then an unlimited number of further nodes may be inserted between nodes α and β without falsifying the original dominance statements. That is, we could formally represent the structure in (58) as follows (where the statement $\text{dom}(\alpha, \beta)$ means that node α dominates node β):

(59)

$$\begin{array}{l} \text{dom}(\alpha, \beta) \\ \text{dom}(\beta, \gamma) \end{array}$$

Now, suppose we insert node δ between nodes α and β , yielding the following structure:

$$(60) \quad \begin{array}{c} \alpha \\ | \\ \delta \\ | \\ \beta \\ | \\ \gamma \end{array}$$

When transforming from the description of (58) as (59) to the description of (60), the parser may end up with the following description:

$$(61) \quad \begin{array}{l} \text{dom}(\alpha, \beta) \\ \text{dom}(\beta, \gamma) \\ \text{dom}(\alpha, \delta) \\ \text{dom}(\delta, \beta) \end{array}$$

Note that all previous statements, that appeared in (59), are still true. That is, node α still dominates β . The proposal of D-theory then is that the description can be changed as long as it does not falsify previous statements regarding dominance. This idea has been used in various theories regarding the human parser.

Weinberg (1993, 1995), as well as Gorrell (1995), have suggested that unconscious syntactic reanalysis (that is, a reanalysis that does not result in a processing breakdown) will be possible if the revision can be accomplished without falsifying any structural relation asserted in a previous state. Yet, unlike Weinberg (1993), who allows the parser to update descriptions by eliminating underspecified node labels in the description, Gorrell (1995) does not permit underspecification of node labels. Rather, Gorrell (1995) advances a parser that can only add more relations.¹⁷

Gorrell (1995) makes a distinction between *primary relations* (that is, dominance and precedence), and *secondary relations* (e.g., theta-role assignment, c-command, Case assignment, government, binding etc.). According to his theory, the parser computes a tree where nodes are connected via dominance and precedence relations. Once these primary relations are computed, “the realization of the secondary relations becomes possible. For example, whether or not a government relation holds between two nodes cannot be determined unless they are connected in a tree structure.” According to Gorrell (1995), the parser can only add (rather than change or erase) primary relations during processing. Gorrell (1995) terms this *Structural Determinism (SD)*:

¹⁷A parser that can only add relations to the existing description is called a *monotonic parser*

- (62) **Structural Determinism (SD)**: The domain of determinism is limited to the primary structural relations, dominance and precedence.
 -Gorrell (1995), Chapter 4, (8)

Under Structural Determinism, both dominance and precedence relations have to be preserved during processing. Other relations might change, as the tree-description consists of dominance and precedence relations only. In other words, the parser will be able to perform unconscious reanalysis only when it does not violate *informational monotonicity*, which Sturt & Crocker (1996) define it as follows:

- (63) **Informational Monotonicity**: The tree-description at any state n must be a subset of the tree-description at state $n + 1$. Thus the parser may not delete relations from the tree description.
 -Sturt & Crocker (1996), Chapter 3, (4)

4.2.2 Examples under Structural Determinism

After reviewing the principles behind the proposal described in Gorrell (1995), we shall now consider this theory given a few examples. At first, consider (1), repeated below as (64):

- (64) _{CP}While Mary was mending the clock started to chime.

When the parser reaches *the clock*, it attaches this DP as a complement of the matrix verb *mending*, resulting in the following structure:¹⁸

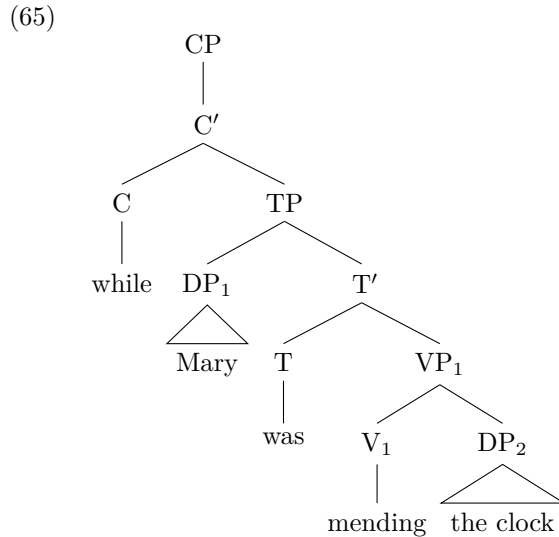

¹⁸For simplicity's sake, and in line with the literature that discusses sentences such as (64) (e.g., Gorrell (1995), p.79), I assume that *while* is a complementizer placed in C. My explanations below are valid in case it is analyzed as a preposition as well.

Within the set of primary relations, the fact that the VP_1 dominates DP_2 should be included: $\{\dots, \text{dom}(VP_1, DP_2), \dots\}$ should be encoded.

Yet, when the parser encounters the rest of the sentence, the initial analysis above is proven wrong, and a reanalysis is required. This reanalysis results in the following structure:

(66)

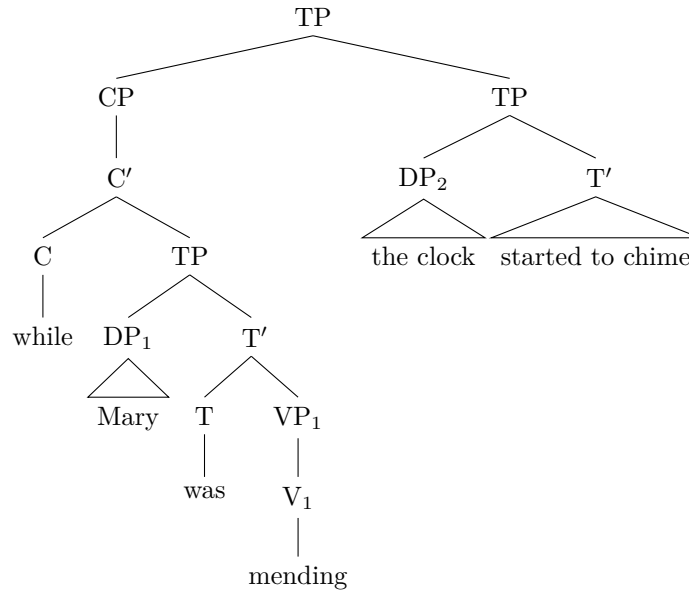

As can be seen from the structure above - a primary relation has been falsified, namely the dominance relation between VP_1 and DP_2 , encoded as $\text{dom}(VP_1, DP_2)$ above. In other words, the fact that VP_1 does not dominate DP_2 following the reanalysis can be accounted for under Structural Determinism as defined above, and (64) is correctly predicted to cause a garden path effect.

Now, consider (29), repeated below as (67):

- (67) a. OK John believed the man.
 b. OK John believed the man cheated.

As described in section 4.1.1, neither of the sentences in (67) cause a processing breakdown. When processing (67a), the parser computes the following structure:

(68)

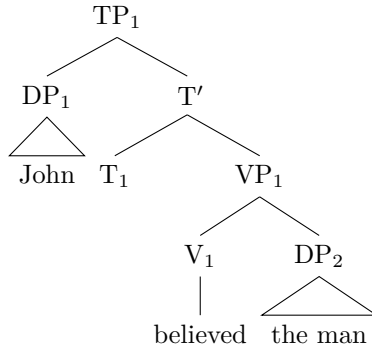

In the above structure, the parser has attached *the man* as a complement of the matrix verb *believed*. Consequently, within the set of primary relations, the fact that the VP₁ dominates DP₂ should be included. In addition, the fact that V₁ precedes DP₂ should be encoded as well: {..., dom(VP₁, DP₂), prec(V₁, DP₂) ... }.

Yet, in case the sentence continues as in (67b), a reanalysis is required - namely repositioning *the man* as the subject of the sentential complement. The resulting structure is as follows:

(69)

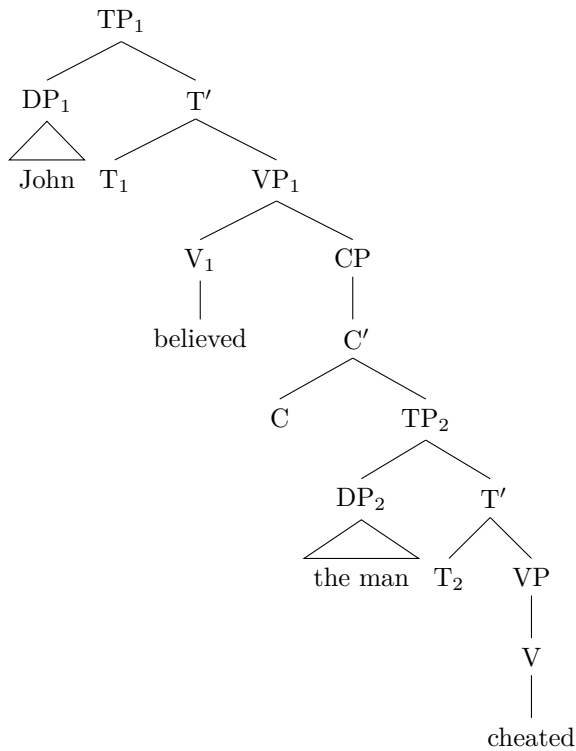

According to Gorrell (1995), during this reanalysis, the parser adds a few relations to the computation - specifically, $\{\dots, \text{dom}(\text{VP}_1, \text{CP}), \text{prec}(V_1, \text{CP}), \text{dom}(\text{CP}, \text{TP}_2), \text{dom}(\text{TP}_2, \text{DP}_2, \dots)\}$. Crucially, unlike the reanalysis performed during the processing of (64), this reanalysis does not falsify any previously made statement regarding primary relations. That is, VP_1 still dominates DP_2 , and V_1 still precedes DP_2 . All other primary relations are also preserved. Hence, Structural Determinism is not violated, and the sentence is correctly predicted to be parsed without conscious difficulty.

Note that the above reanalysis does entail revision of *secondary* relations. For instance, prior to reanalysis, V_1 governed DP_2 . This relation is not valid after the reanalysis has taken place. Yet, according to (62), the domain of determinism is limited to *primary* relations only, and thus Structural Determinism is not violated.

Another way to view reanalysis in a way compatible with Structural Determinism is the mechanism used by the parser proposed in Sturt & Crocker (1996) - namely, *Tree Lowering* (henceforth: “lowering”). Looking at (67b) above again, we could say that DP_2 , namely *the man*, has been *lowered* from its position as a complement to the matrix verb in (68), to the subject position of the subordinate clause. The source position of the lowered node (its position before lowering) is guaranteed to dominate its target position (*after* lowering). This characteristic of the lowering operation is identical to the dominance condition of the OLLC, presented in section 4.1.1. Yet, the intuition of lowering sheds light on some interesting cases, especially in head-final languages, as will be shown in section 4.2.3.

Note that parsers such as those described by Gorrell (1995) or Sturt & Crocker (1996) do not employ Theta Attachment, but rather *immediate attachment*, according to which structure is built even prior to the arrival of the theta-assigner. Details and motivations regarding this view will be given in section 5. For now, we shall focus on the point of reanalysis only, and will not consider each step of processing.

4.2.3 Head-final languages

Let us consider how lowering can be used in reanalysis while parsing in head-final languages, such as Japanese, Chinese and Korean.

As Japanese is a strict verb-final language, where verbs follow all of their arguments, in multi-clause sentences, the embedded verb precedes the main verb, as in (70) ((4) in Aoshima et al. (2004)).

- (70) John-wa Mary-ga sono hon-o nakusita-to omotteiru
 John-top Mary-nom that book-acc lost-Comp thinks
 ‘John thinks that Mary lost that book’

With that in mind, let us consider the following example, originally described in Mazuka & Itoh (1995), and also discussed by Gorrell (1995) and Sturt & Crocker (1996):

- (71) a. _{OK} Yamasita-ga yuuzin-o hoomonsita siriai-ni
 Yamasita-NOM friend-ACC visited acquaintance-DAT
 tegami-o kaita
 letter-ACC wrote
 'Yamasita wrote a letter to an acquaintance who visited his friend.'
- b. _{GP} Yamasita-ga yuuzin-o hoomonsita kaisya-de mikaketa
 Yamasita-NOM friend-ACC visited company-LOC saw
 'Yamasita saw his friend at the company he visited.'

We shall first consider the processing of (71a). The initial analysis built by the parser consists of the following main clause:

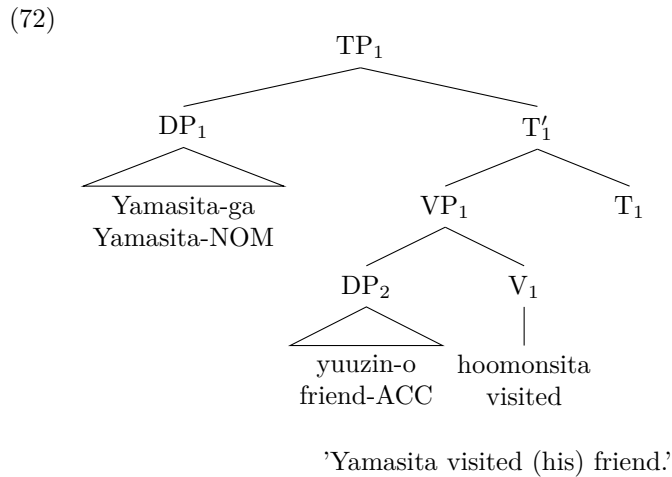

Now, the parser encounters *acquaintance*. It is now clear that the initial analysis is wrong, and thus a reanalysis is required, constructing a relative clause modifying the newly encountered DP.

Consider the final structure that the parser constructs for (71a):

(73)

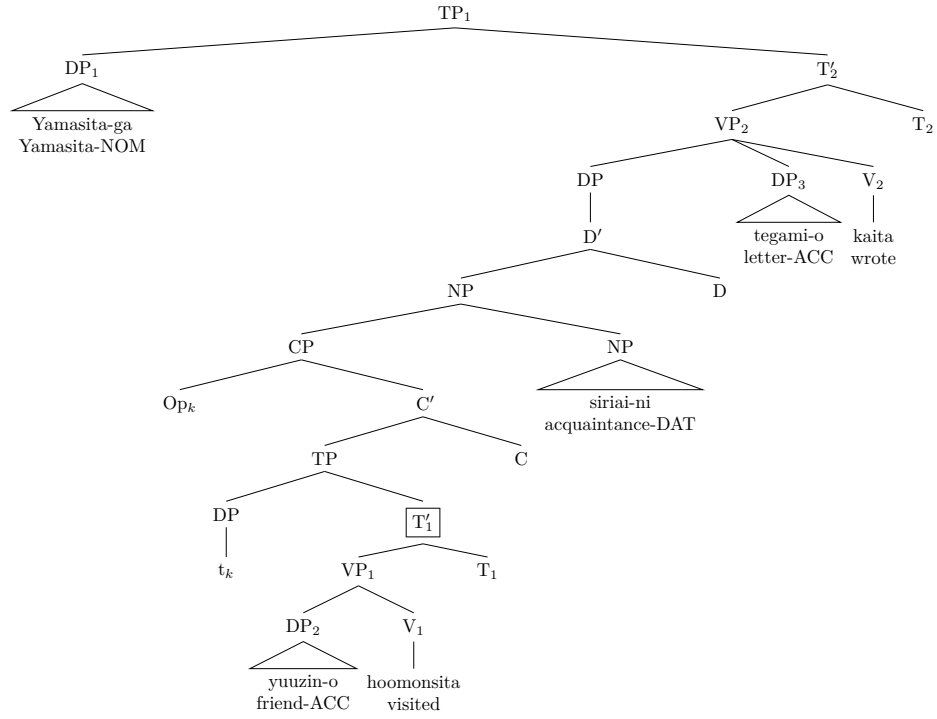

'Yamasita wrote a letter to an acquaintance who visited his friend.'

Mazuka & Itoh (1995) claim that during the reanalysis above, DP₁ (*Yamasita*) has been *displaced* from within the relative clause. Such a displacement violates Structural Determinism. However, as Gorrell (1995) notes, it is possible to alternatively claim that during the reanalysis the constituent which is dominated by T'₁ has been *lowered*. That is, this is the same constituent T'₁ (marked by a box) in (72) (and DP₁ remains in [SPEC TP₁]). Under this view - Structural Determinism is maintained, as no primary relations have been falsified. For instance, T'₁ in (73) still dominates VP₁, as in (72). Similarly, TP₁ dominates T'₁, as well as DP₁. In addition, as in (72), VP₁ dominates DP₂.

Let us now consider sentence the garden path sentence (71b). The initial analysis built by the parser is identical to that of (71a):

(74)

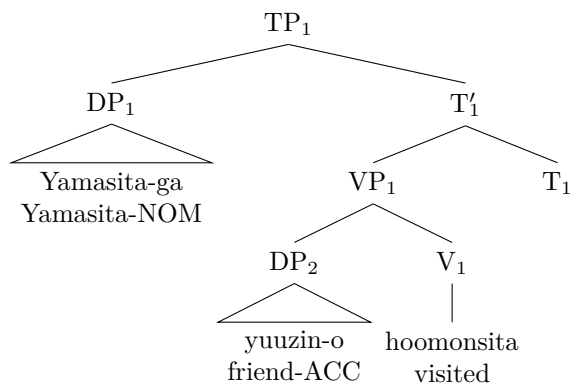

'Yamasita visited (his) friend.'

At this point, the parser encounters *company*. This time, in contrast to (71a), lowering T'₁ is not a viable option. That is, a “single-displacement” is not semantically possible, since it would yield the meaning of “(at) the company that visited (his) friend”. Thus, a “double-displacement” must take place - that is, both *Yamasita* and *friend* will have to be positioned in the matrix clause in the final structure, rather than in the relative clause:¹⁹

¹⁹At first, the parser is assumed to consider the “null-displacement” option - that is, yielding the meaning “(at) the company where Yamasita visited his friend”. However, once the matrix verb *saw* is encountered, there are no arguments that can receive its thematic roles. If the parser posits *pro* for both the subject and the object, then we would have two arguments with no identified antecedents. Therefore, this option is not preferred. Section 6.3 and footnote 58 explicitly states the principles responsible for these preferences.

(75)

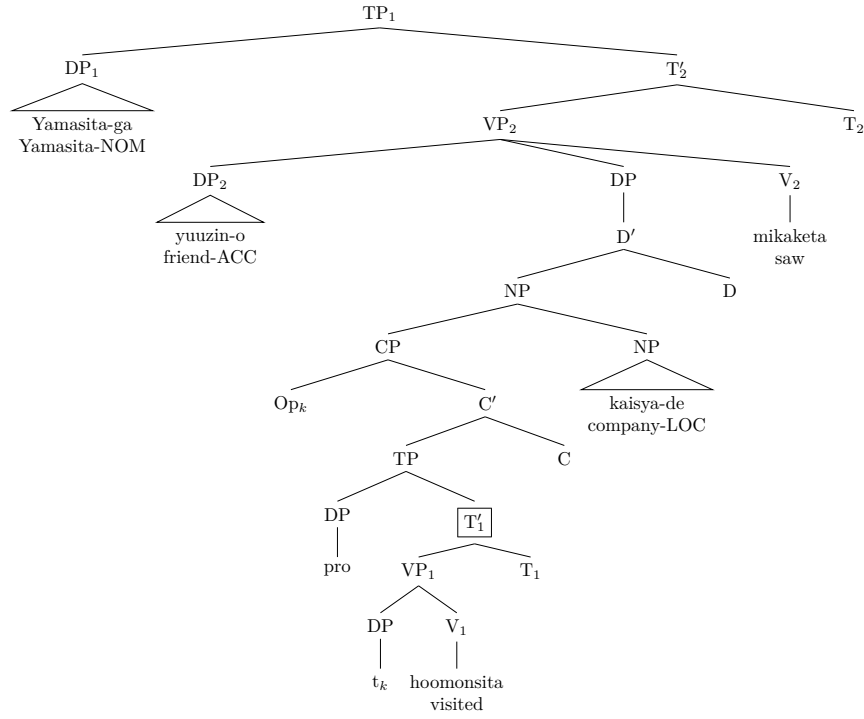

'Yamasita saw his friend at the company he visited.'

Consider the constituent T'_1 prior and following the reanalysis:

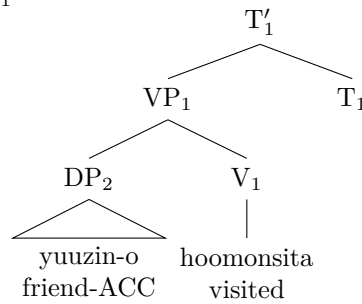
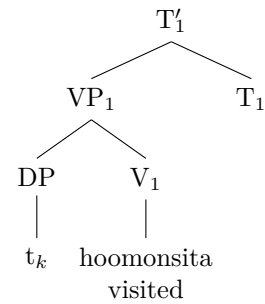
(72)- T'_1 (75)- T'_1 

The above reanalysis does not preserve Structural Determinism, since the primary relation $\text{dom}(\text{VP}_1, \text{DP}_2)$ is falsified following the reanalysis. That is, DP_2 (*friend*) is no longer dominated by VP_1 , as it has been displaced to the object position of the matrix clause. Thus, this reanalysis cannot occur unconsciously according to Gorrell (1995) or Sturt & Crocker (1996). As explained above, no primary relations are falsified during the processing of (71b). Therefore, the difference between (71a) and (71b) is well accounted for under Structural Determinism.

Let us now consider the following Chinese examples from Lee (2006). In Chinese, the verb precedes its complement, but a relative clause precedes its head.

- (76) a. _{OK} Wang jingli xihuan he Faguo putaojiu de weidao
 Wang manager like drink French wine NOM taste
 'Manager Wang likes to drink (for) the French wine's taste.'
- b. _{GP} Wang jingli xihuan he Faguo putaojiu de guyuan
 Wang manager like drink French wine NOM employee
 'Manager Wang likes employees that drink French wine.'

To my knowledge, this kind of sentences has not been considered under Structural Determinism. Let us begin with (76a), which does not yield conscious processing difficulty. Upon parsing the sentence, the parser first computes a structure in which the matrix verb, *likes*, takes a sentential complement, *to drink French wine*. The resulting structures is provided below.

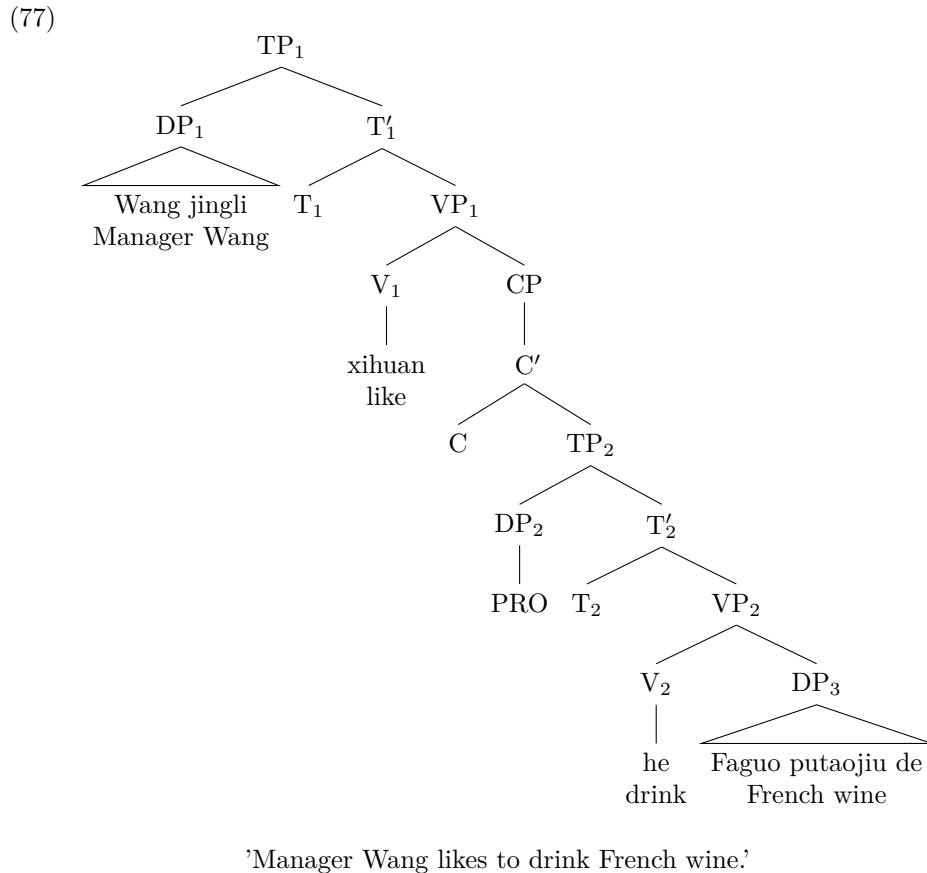

At this point in processing, the parser encounters *taste*, and reanalysis is required. That is, *French wine* turns out to be not the object of the verb *drink*, but rather a modifier of the whole phrase *French wine's taste*, as follows.

(78)

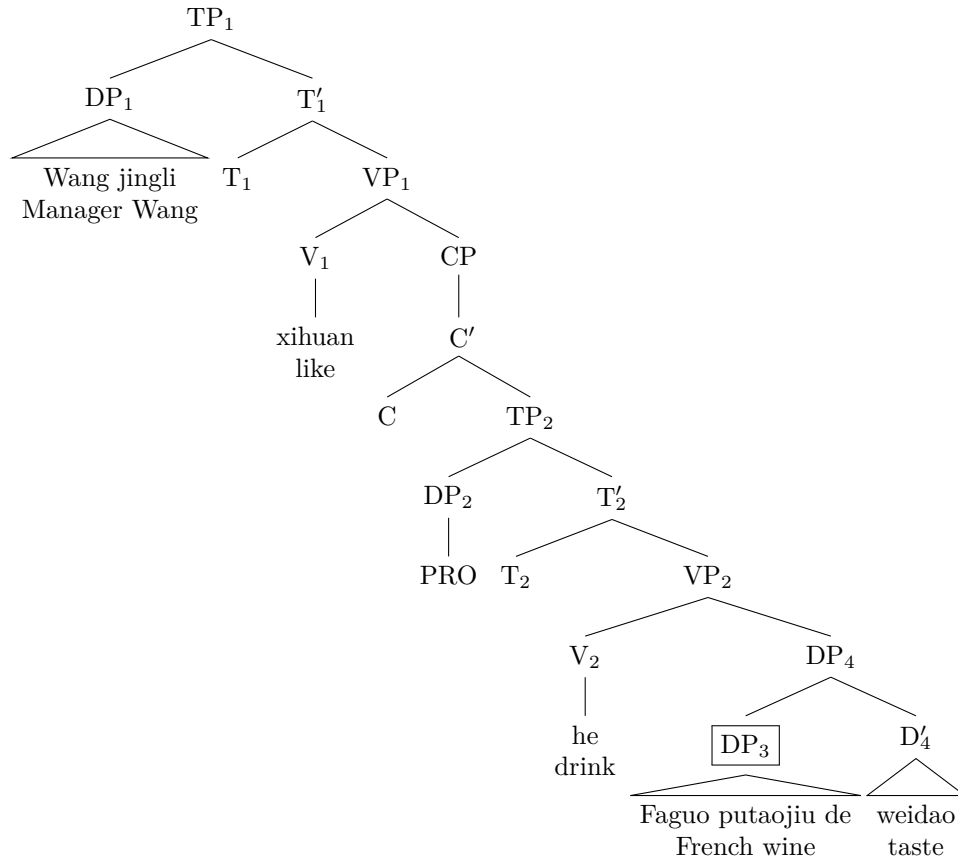

'Manager Wang likes to drink (for the) French wine's taste.'

The reanalysis above does not falsify any primary relations, and is thus compatible with Structural Determinism. Specifically, prior to reanalysis, VP₂ dominates DP₃, and V₂ precedes DP₃. These relations remain valid after the reanalysis. That is, nodes DP₄ and D'₄ (as well as all nodes dominated by D'₄) have been added to the structure, by the means of adding primary relations (dom(DP₄, DP₃), prec(DP₃, D'₄), ...), without falsifying any existing relations. In other words, DP₃ (marked above) has been lowered from the direct object position of *drink* to a modifier position within this object.

Let us now consider the garden path sentence (76b). As (76b) is identical to (76a) up to and including the word *wine*, the same structure has been built by this point as for (76a), namely the structure presented in (77) above. Yet, unlike in (76a), the parser now encounters a different noun, *employees*. The

parser can no longer employ the lowering mechanism and position *French wine* as modifying the *employees*, because that would result in an invalid semantic interpretation. Rather, the parser realizes that the CP [to drink French wine] is not the direct object of the matrix verb *likes*, but is rather a relative clause modifying the noun *employees*, as below:

(79)

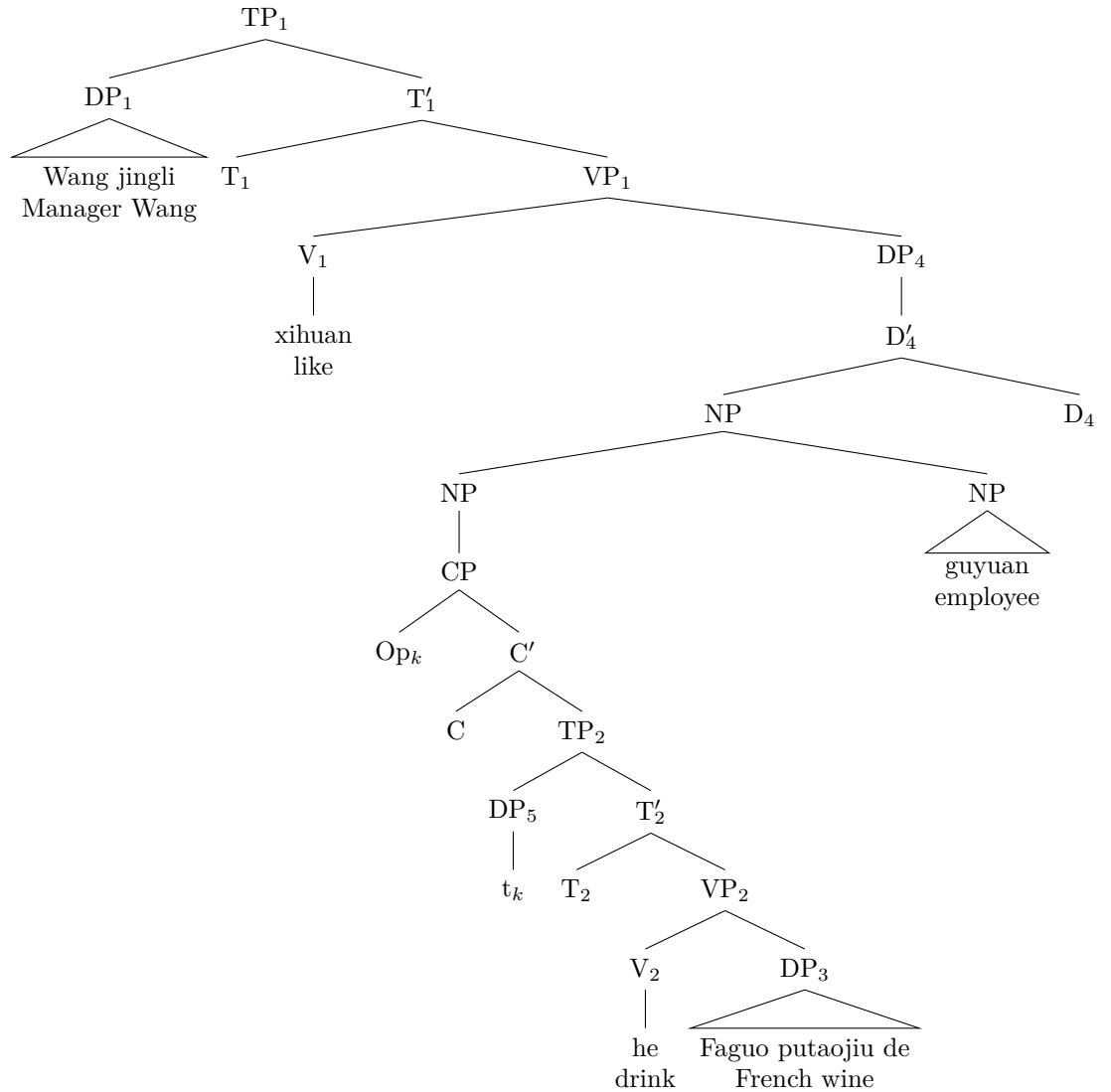

'Manager Wang likes employees that drink French wine.'

Unlike the reanalysis we have considered in the processing of (76a), the reanalysis described in (79) does violate Structural Determinism. Namely, the

previously established relation $\text{dom}(\text{TP}_2, \text{DP}_2)$ that is established in (77), has been falsified - since DP_2 (*PRO*) no longer exists in the structure. Note that in this case Structural Determinism is violated, even though the the discarded element is no longer in the tree description.²⁰

To sum up, Structural Determinism accounts well for sentential complement / relative clause ambiguity in Chinese.

Let us now consider Korean, head-final examples from Suh (2005):

- (80) a. $_{\text{OK}}$ Kiho-nun Mina-eykey Yumi-ka ecey swuswul-ul
 Kiho-TOP Mina-DAT Yumi-NOM yesterday operation-ACC
 hayssta-ko malhayssta
 did-COMP said
 'Kiho told Mina that Yumi underwent an operation yesterday.'
- b. $_{\text{GP}}$ Kiho-nun Mina-eykey Yumi-ka ecey sokayhayssta
 Kiho-TOP Mina-DAT Yumi-NOM yesterday introduced
 'As for Kiho, Yumi introduced him to Mina yesterday.'

In Korean, Subject DPs can be Topic-marked as well as Nominative-marked. The choice of subject markers is tied to whether the sentence is depictive or presentational (Suh (2003)). When the parser encounters *Kiho-TOP*, in either of the sentences presented in (80), it has two options. As Suh (1994) explains, there are two types of topics in Korean. The first is base-generated, and occurs in the subject position of a depictive sentence. The second type involves syntactic movement, and functions as a complement or an adjunct.²¹ In the process of parsing either of the sentences in (80), the parser seems to prefer the first type, namely a base-generated subject, according to Suh (2005).²² In light of that, the parser constructs the following structure:

²⁰In this case, it is a phonetically unrealized category that has been erased from the structure. I discuss evidence for the role of empty categories in processing in section 8.2.

²¹These topics, which function as a complement or an adjunct, seem to obey movement constraints (Lasnik & Saito (1994)).

²²Section 6.1 provides an in-depth explanation for Suh's (2005) account regarding this preference.

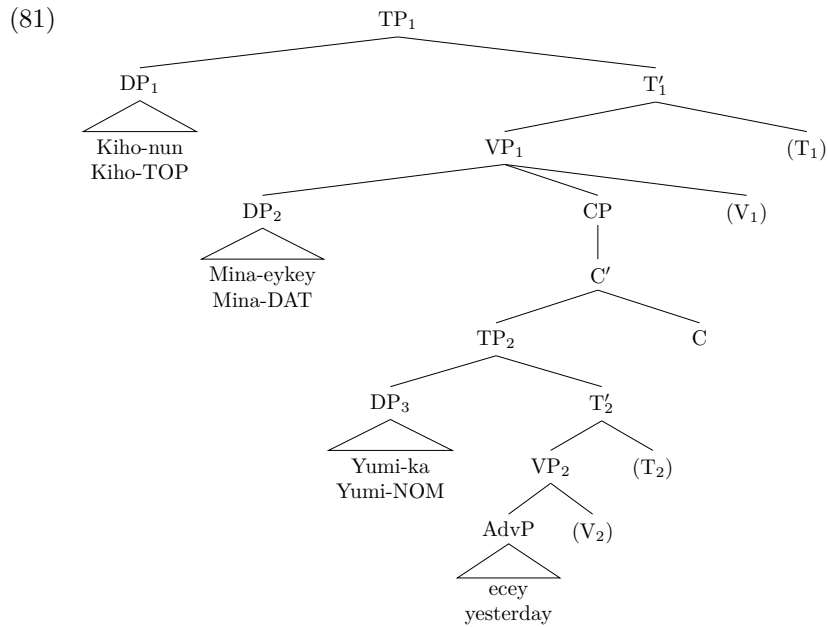

That is, given that *Kiho* is placed as a base-generated subject, *Mina* is attached as a complement to the verb that is yet to appear. Since *Yumi* is marked with a nominative Case, it is attached as a subject of a sentential complement.

From the structure depicted in (81), the parser may continue processing without difficulty when facing sentence (80a) - that is, *operation* is attached as the object of V_2 , *did* as V_2 , *ko* as C and *said* as V_1 , as follows:

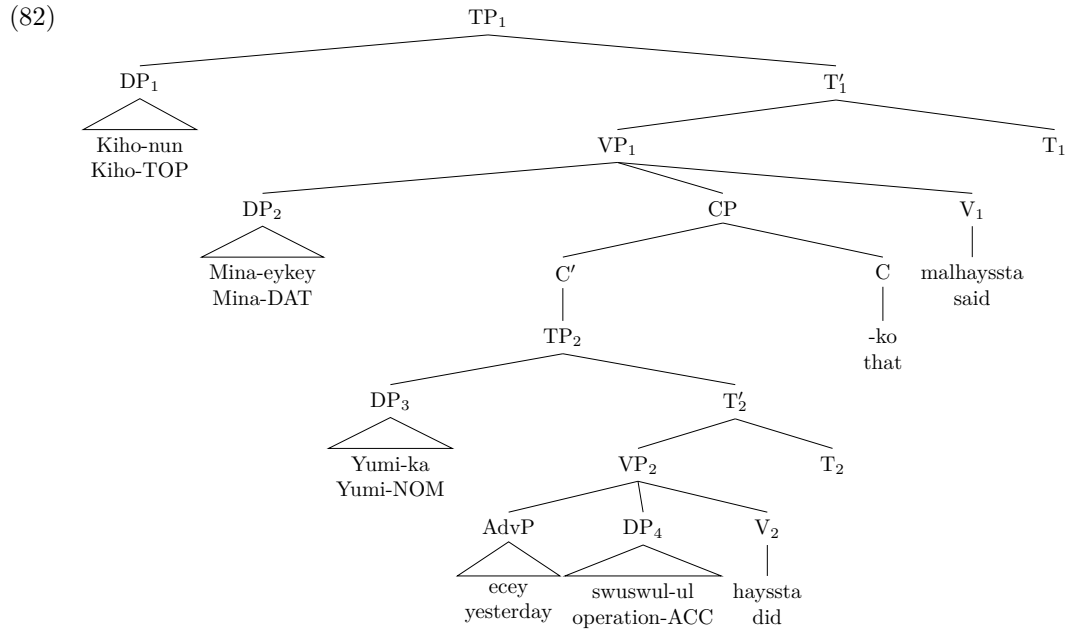

'Kihonun told Mina that Yumi underwent an operation yesterday.'

Note that the parser only *added* nodes and relations when transitioning from the structure described in (81), to the one presented in (82). In fact, no reanalysis took place.

The situation is different when the parser is facing sentence (80b). At first, the parser constructs the same structure (81) as for (80a) above, owing to the preference for base-generated topics. Notice that, as Suh (2005) explains, in order to derive a grammatical structure from (81), two verbs are necessary - the head of VP₁ (V₁) and the head of VP₂ (V₂). Since (80b) only includes one verb, it is inconsistent with the structure in (81) and thus a reanalysis is required, yielding a structure where *Kihonun* is a topic moved from the object position of V₂.

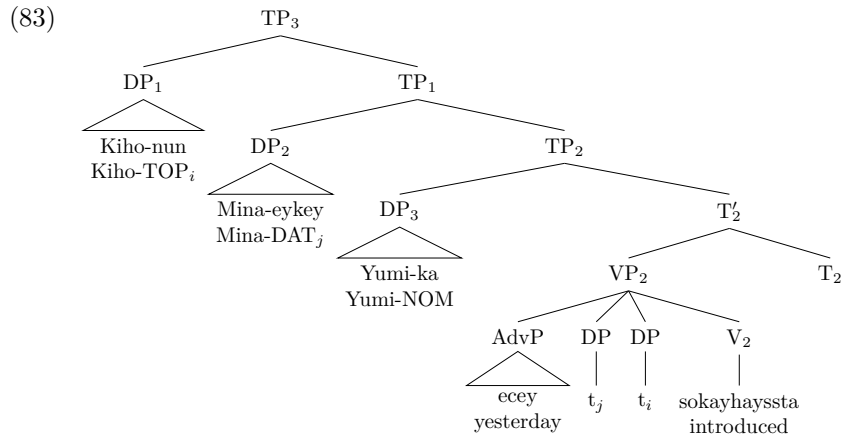

'As for Kiho, Yumi introduced him to Mina yesterday.'

This reanalysis violates Structural Determinism. Specifically, the primary relation $\text{dom}(\text{TP}_1, \text{DP}_1)$ that existed in (81) is no longer valid, since TP_1 is no longer removed from the tree. The same applies to many other relations, including $\text{dom}(\text{T}'_1, \text{VP}_1)$, as VP_1 no longer exists in the structure. Since (80b) violates Structural Determinism, and (80a) does not violate Structural Determinism, we can conclude the Structural Determinism accounts for the data regarding this type of sentences in Korean as well.

4.2.4 Issues with Structural Determinism

Despite the impressive empirical coverage of Structural Determinism, I found a few examples where the data contradicts its predictions.

Let us reconsider the Japanese sentence (49) introduced in section 4.1.4, and repeated below as (84):

- (84) _{OK} Nakamura-ga tyuuko-no pasokon-o katta toki
 Nakamura-NOM second-hand PC-ACC bought when
 syuuri-site-kureta.
 repaired(for-me)
 'Nakamura_i, when (I_j) bought a second-hand PC, repaired (it) for me_j'

We have already depicted the processing of the sentence in section 4.1.4, as part of our discussion regarding examples that contradict the predictions made by the OLLC. Let us shortly review the processing of this sentence again, this time without assuming Theta Attachment. When the parser encounters *bought*, the following clause can be constructed - '*Nakamura bought a second-hand PC*'. This might have been the entire sentence, as it is grammatical. Then, *when* is encountered, so a *CP* is constructed as follows:

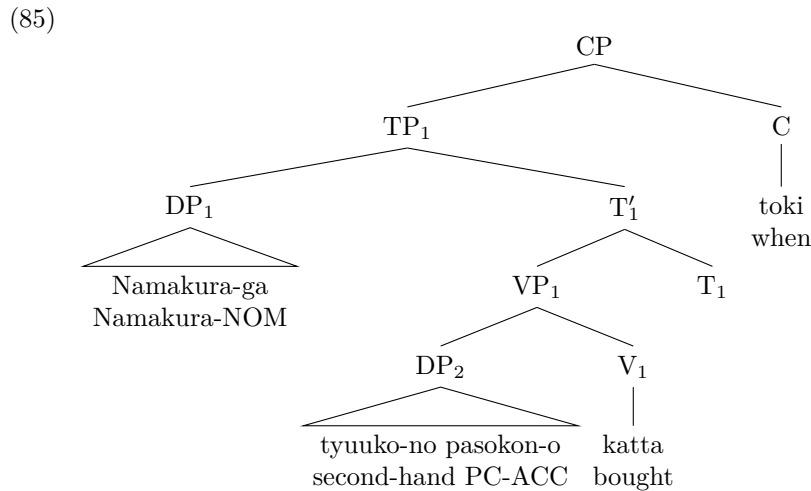

'When Nakamura bought a second-hand PC'

Next, the parser encounters *repaired (for-me)*. Recall that in section 4.1.4, it was explained that the morpheme *kureta* (suffixed to *repair*) makes it clear that the repair was done for the speaker. Hence, it becomes apparent that the speaker is the one who has bought the computer, and Nakamura must be the subject of the matrix clause. Thus, the parser performs following reanalysis:

(86)

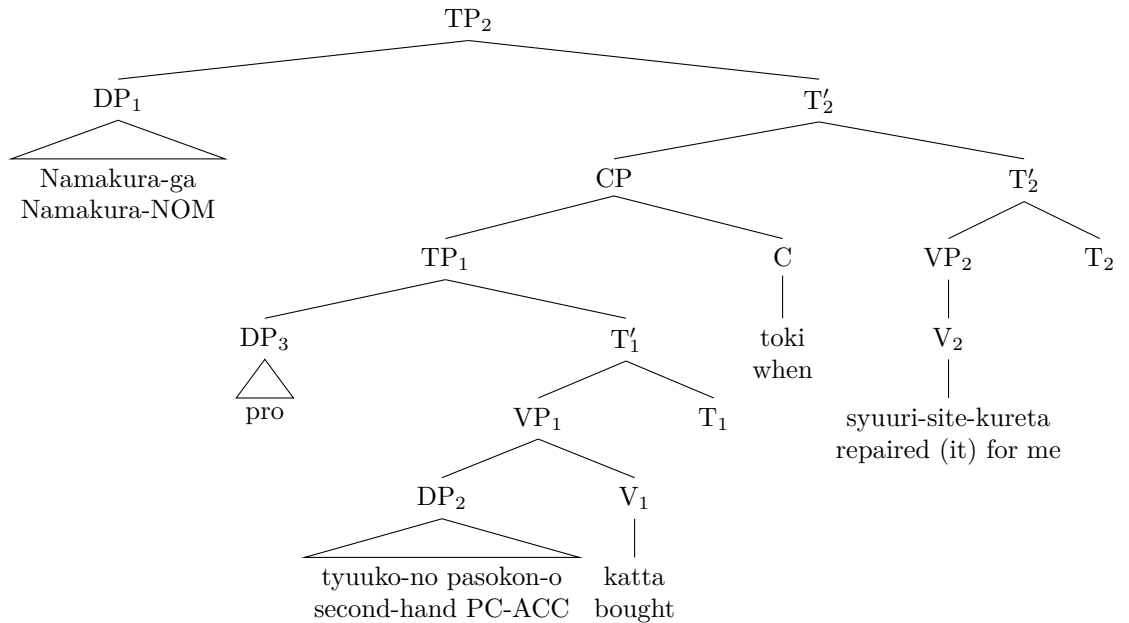

'Nakamura_i, when (I_j) bought a second-hand PC, repaired (it) for me_j.'

Nakamura has been relocated from the subject position of the adjunct, where it is positioned in (85), to the subject position of the matrix clause. This reanalysis violates Structural Determinism as it falsifies primary relations that were evident in (85), specifically $\text{dom}(\text{TP}_1, \text{DP}_1)$. Thus, Structural Determinism theories wrongly predict (84) to yield a garden path effect.

One might argue that the constituent T'_1 has been lowered, and the node that I marked as TP_2 in (86) is actually TP_1 . However, this argument is invalid since TP_1 in (85) is already dominated by CP, and its lowering without CP would violate Structural Determinism.

Finally, it may be suggested that the parser has predicted the reanalysis-to-come, and lowered T' when it has encountered *when*. However, this argument does not hold, since it is possible for the sentence to continue without extracting *Nakamura*. Mazuka & Itoh (1995) provide an example of such a sentence:

- (87) _{OK} Nakamura-ga tyuuko-no pasokon-o katta toki
 Nakamura-NOM second-hand PC-ACC bought when
 syuuri-site-yatta.
 repaired(for-him)
 'When Nakamura_i bought a second-hand PC, (I_j) repaired (it) for him_i.'
 -Mazuka & Itoh (1995), (10)

In (87), the parser encounters *repaired(for-him)*. As the verb is marked with *yatta*, the preferred interpretation is that the speaker repaired the computer for Nakamura, when Nakamura bought the computer.²³ Thus, in (87), *Nakamura* does not have to be reanalyzed - it remains the subject of the embedded verb *bought*, receiving its external thematic role. This sentence does not violate Structural Determinism.

That is, (87) shows that the parser cannot tell whether *Nakamura* will turn out to be the subject of the subordinate clause or the subject of the matrix clause, until the appearance of the matrix verb. Importantly, Mazuka & Itoh (1995) found out that sentences (84) and (87) "are alike in their ease of comprehension". That is, neither of them causes a garden path effect, even though (84) violates Structural Determinism, whereas (87) does not.

Before considering another Japanese sentence which is wrongly predicted to result in a garden path effect under Structural Determinism, let us recall the garden path sentence (52) introduced in section 4.1.4, and listed below as (88):

- (88) _{GP} Yoko-ga kodomo-o koosaten-de mikaketa takusii-ni noseta.
 Yoko-NOM child-ACC intersection-LOC saw taxi-DAT put-on
 'Yoko put the child on the taxi she saw at the intersection.'

Let us shortly review the parsing of (88). When encountering the verb *saw*, the parser has constructed the following structure:

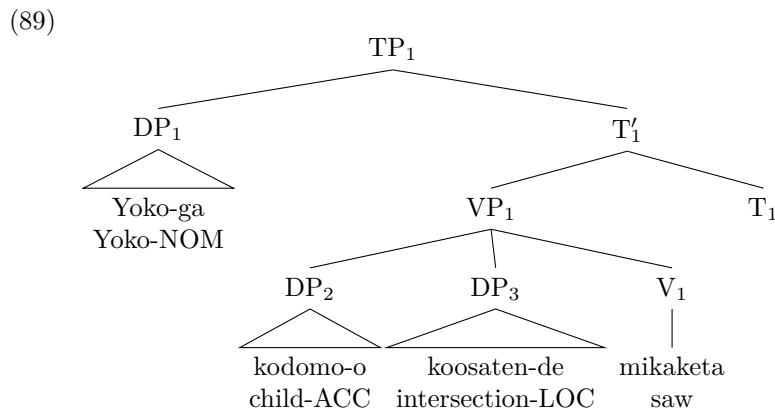

²³As Mazuka & Itoh (1995) explain (and as mentioned in section 4.1.4), in Japanese, there are verbs of giving and receiving, "the choice of which depends on whether the beneficiary/benefactor is the speaker or the third person". In section 4.1.4 we have seen an example where the morpheme *kureta*, rather than *yatta*, was affixed to the verb *repair*, and thus the reading was different.

'Yoko saw the child at the intersection.'

The above structure describes a grammatical matrix clause, and the sentence might have ended that way. When the parser encounters *taxi*, it becomes clear that the structure above is incompatible with the sentence, and should be reanalyzed. As mentioned in section 4.1.4, *taxi* cannot be assigned the external thematic role of *saw*, and thus an object relative clause must be constructed - that is, 'the taxi that she saw at the intersection' (since there is no subject available for the relative clause, a *pro* is inserted as the subject).

The final structure of the sentence is as follows:

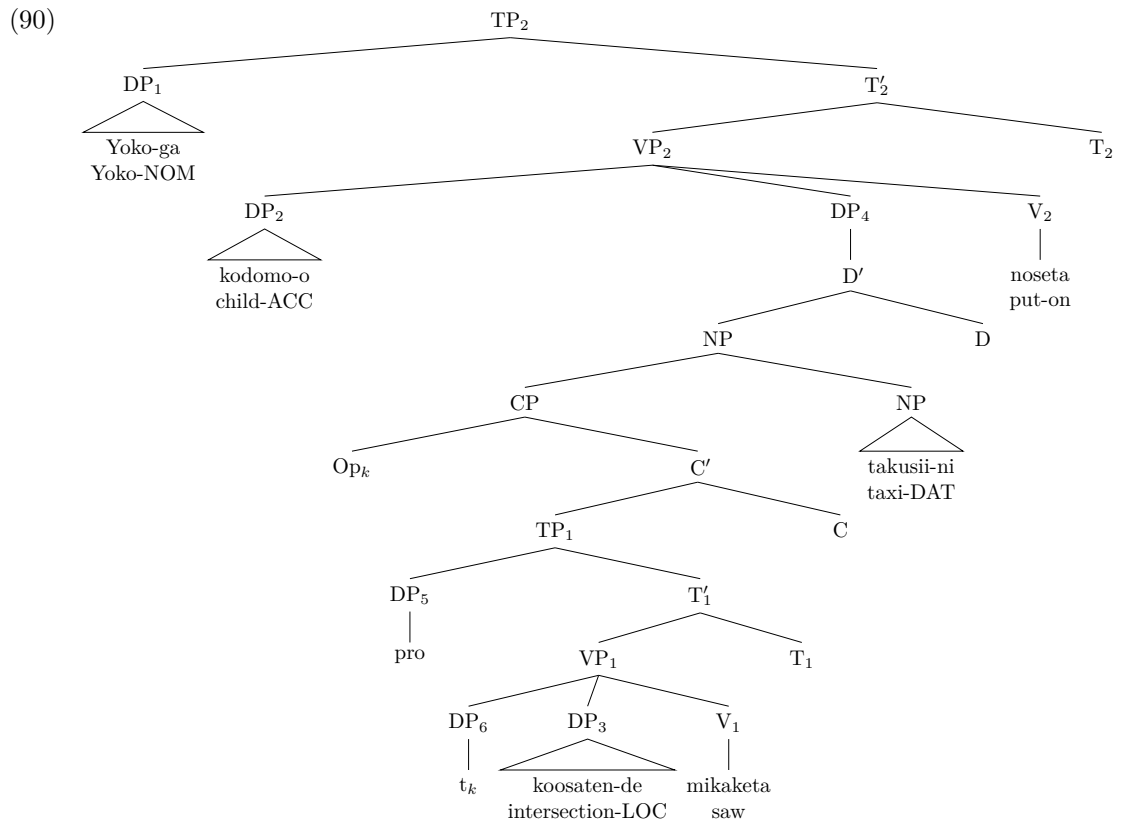

'Yoko put the child on the taxi she saw at the intersection.'

This reanalysis violates Structural Determinism, as the primary relation $\text{dom}(\text{TP}_1, \text{DP}_1)$ in (89) is no longer valid in (90). However, it could be argued that the constituent T'_1 has been lowered, and the node labeled as TP_2 in (90) is actually TP_1 from (89). However, it is clear that the relation $\text{dom}(\text{VP}_1, \text{DP}_2)$ does not hold in (90), even though it has in (89). Hence, Structural Determinism is violated, and sentence (88) is correctly predicted to result in a garden path effect. From this sentence we can see, that the extraction of the object (*child*),

and the creation of the object relative clause, has led to the clear violation of Structural Determinism.

Let us now consider the following sentence, wrongly predicted by Structural Determinism to yield a garden path effect:

- (91) $\text{OK}\emptyset$ kodomo-o koosaten-de mikaketa takusii-ni noseta.
 \emptyset child-ACC intersection-LOC saw taxi-DAT put-on
 ‘ \emptyset put the child on the taxi (s)he saw at the intersection.’
 -Mazuka & Itoh (1995), (18a)

While sentence (91) seems very similar to (88), it does not result in a processing breakdown. Let us consider the parsing of this sentence. Similar to the structure in (89), by the time the parser reaches the verb *saw*, the following structure has been constructed:

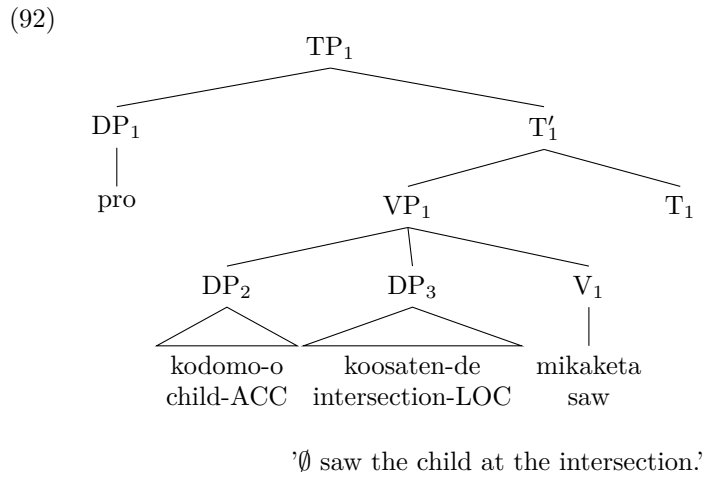

When the parser encounters *taxi*, the structure above has to be reanalyzed, and an object relative clause must be constructed. The final structure that the parser computes is presented below:

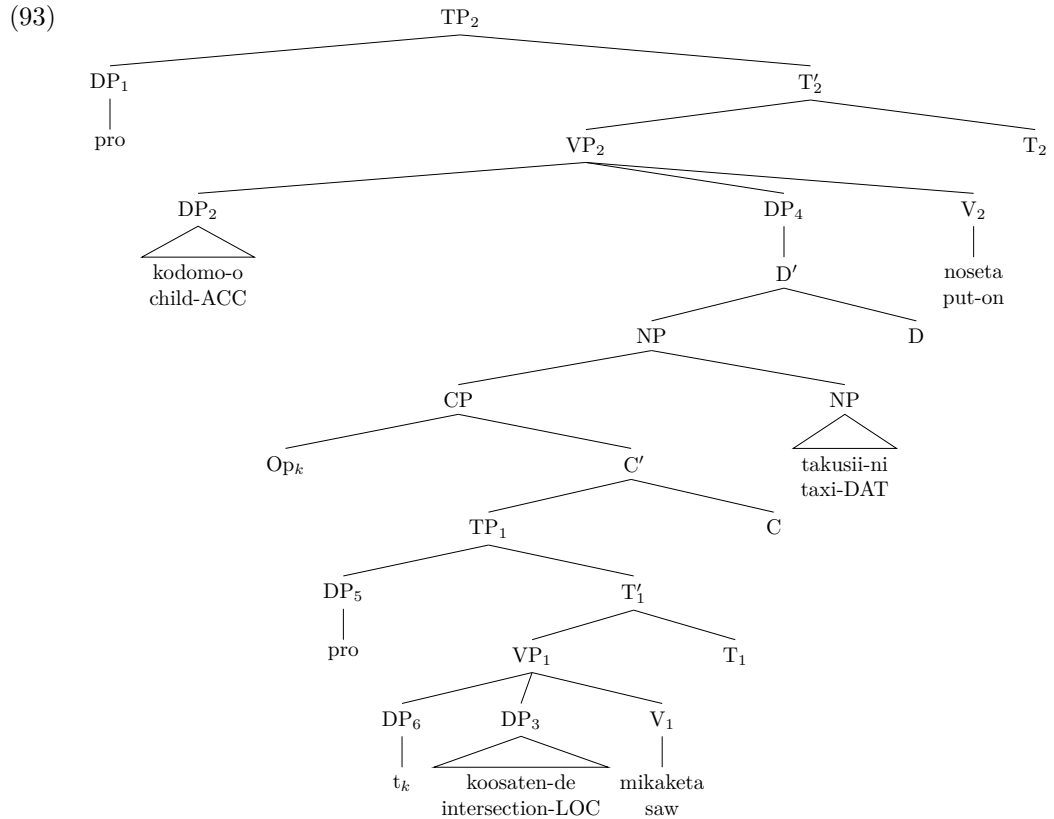

' \emptyset put the child on the taxi (s)he saw at the intersection.'

Just like the reanalysis described for sentence (88), the previously existing relation $\text{dom}(\text{VP}_1, \text{DP}_2)$, no longer holds after the reanalysis. In other words, Structural Determinism is violated in the process of parsing sentence (91), just as it was violated in the process of parsing sentence (88). Consequently, parsers employing Structural Determinism make the wrong prediction that (88) will lead to a garden path effect.

Above, we have considered a few sentences which parsers employing Structural Determinism predict to yield a processing breakdown, but are in fact easy to process. Yet, I have not been able to find a sentence that yields a processing breakdown, when Structural Determinism predicts that it will be easy to process. All different types of garden path patterns I have identified (listed in Table 1) seem to violate Structural Determinism. This leads me to make the following observation:

(94) **Observation:** When Structural Determinism is maintained during reanalysis, the reanalysis does not result in a processing breakdown.

Of course, we should strive for a theory that can also explain why the sentences described above are easily processed, although they violate Structural

Determinism and are therefore predicted to yield a garden path effect. I will propose such a theory in section 6. Before that, let us consider an additional proposal attempting to account for the garden path phenomenon.

4.3 Reanalysis by movement - Siloni (2004)

In this section, we shall review another proposal, described in Siloni (2004). This theory provides explanations to some examples that have remained unexplained by the OLLC or Structural Determinism.

4.3.1 Structure building operations

Siloni (2004) relies on the structure building operation Merge in Chomsky's (1995) terms. Siloni (2004) characterizes Merge during processing as follows:

- (95) **Merge:**
- a. to optimize satisfaction of θ -relations as soon as possible.
 - b. functional material following the relevant lexical head.
 - c. adjuncts as soon as possible.
- Siloni (2004), (7)

That is, Siloni (2004) adopts Theta Attachment, suggested by Pritchett (1992). Regarding (95c), Siloni (2004) explicitly states that "adjuncts on a par with arguments are attached to the structure as soon as possible." She also provides an explicit explanation for (95a):

- (96) **Optimal satisfaction of θ -relations:**
- a. for θ -relations to be optimally satisfied:
 - (i) a predicate needs to assign its role(s), and
 - (ii) a potential argument needs to be assigned a role.
 - b. an unassigned role "equals" an unattached argument.
- Siloni (2004), (25)

Siloni (2004) also adopts the rebuffering mechanism presented in Pritchett (1992) (and described in section 4.1.3 of the current paper).²⁴

Additionally, Siloni (2004) introduces the definition of *Expand*, an operation which does not result in a garden path effect:

- (97) **Expand:** Merge input (by (95)) to a node dominating the rightmost terminal node.
- Siloni (2004), (11)

Let us consider the parsing process for the following sentence, under these assumptions:

- (98) _{OK}John saw Mary on Thursday.
- Siloni (2004), (10a)

²⁴Siloni (2004) refers to this mechanism as "parking in the store".

At first, the parser encounters *John*. As this DP cannot receive a thematic role, it is stored until the predicate *saw* is encountered, and an initial structure is constructed by merging *John* and *saw*:

(99)

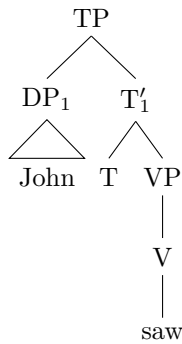

At this point, *Mary* is encountered, and added to the structure using *Expand*, since *Mary* is merged to a node (VP) dominating the rightmost terminal node (namely, V - *saw*). The resulting structure is as follows:

(100)

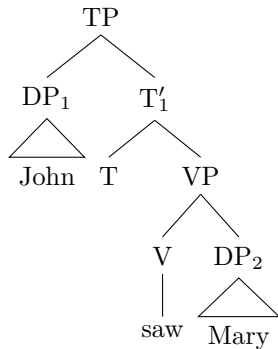

Next, the parser encounters *PP*[on Thursday], an adjunct that should be merged according to (95c). For that, the processor creates an additional intermediate projection (T'₂). This latter node is merged to T'₁, which dominates the rightmost terminal node (namely, *Mary*). Thus, this insertion is also included under *Expand*, as defined in (97). The resulting structure is as follows:

(101)

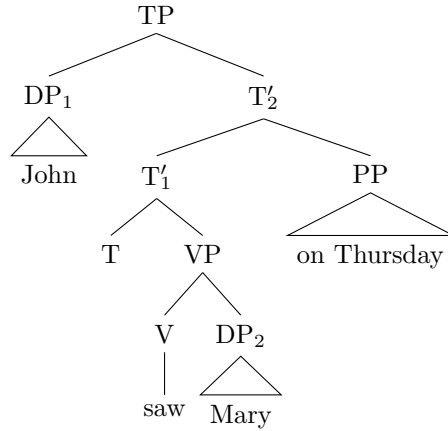

All of the above operations are allowed according to Siloni (2004), and thus it is correctly predicted that (98) does not result in a processing breakdown.

4.3.2 Licit Reanalysis

Siloni (2004) refers to a reanalysis that does not result in a processing breakdown as “licit reanalysis”. She defines it as follows:}

- (102) a. Licit relocation is movement. For movement to be possible, the Target must c-command the Source.
b. The Source (α) is the node to be relocated.
c. The Target is the maximal projection of α in its new merger.
-Siloni (2004), (17)

- (103) **C-command:** α c-commands β iff:
(i) α does not dominate β and β does not dominate α ; and
(ii) the first branching node dominating α also dominates β
-Reinhart (1976); Siloni (2004) (18)

Let us consider how this proposal can explain some of the sentences we have considered in previous sections. Let us reconsider (38b) introduced in section 4.1.2, and repeated again as (104):

- (104) OK They gave her books to Ron.

At first, *They* is sent to the store, and is later merged when the predicate *gave* appears. When *her* is encountered, it is merged as well (under the definition of *Expand*) and the following structure is reached:

(105)

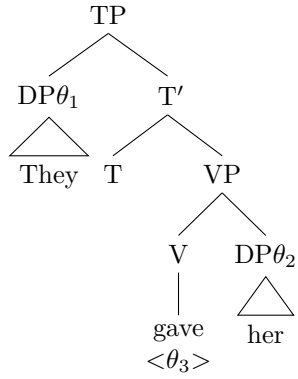

When encountering *books*, the parser must merge it as the second object of *gave*, in order to comply with Theta Attachment. As Siloni (2004) explains, “had *books* expanded the DP *her*, *gave* would have remained with an unassigned θ -role.” The resulting structure is as follows:

(106)

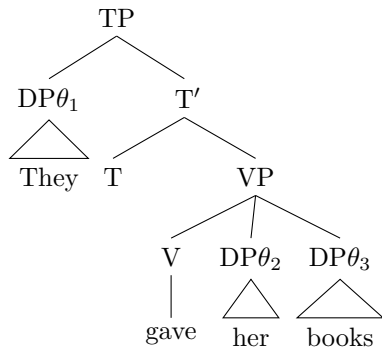

Upon the arrival of *PP*[to Ron], *books* has to expand *her* and be repositioned, in order to void the complement position. The parser then reaches the following structure:

(107)

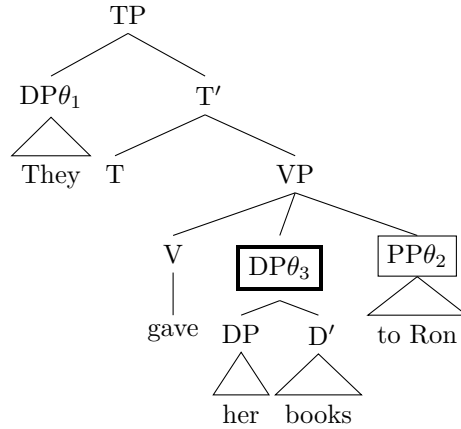

Following reanalysis, the Target (that is, the position of *gave*'s first complement, marked with a bold box) c-commands the Source (namely, the position of *gave*'s second complement, marked with a box). Thus, this reanalysis is correctly predicted to occur unconsciously.²⁵

Now, consider the following example in Modern Hebrew, taken from Siloni (2004):

(108) $\text{G}^{\text{P}}\text{xulca metayelet b-a-vadi}$.

²⁵We may also consider a more recent analysis for the double object construction, namely a VP-shell structure as in Larson (1988) and subsequent work. Let us consider the structure that the parser builds when encountering the word *books* in (104), assuming a VP-shell structure:

(1)

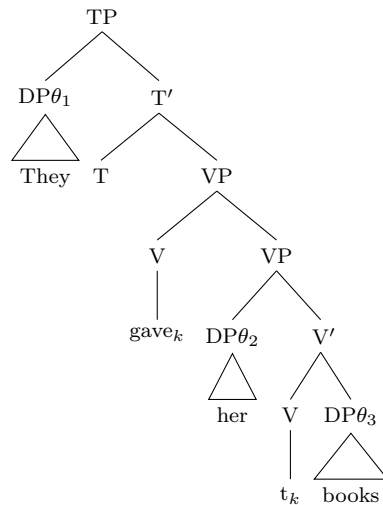

After reanalysis, the VP-shell structure would be:

The string in (108) yields a severe garden path effect. At first, the string is analyzed as (109a) below.²⁶ Yet, as this interpretation is highly improbable, the parser must perform reanalysis, which results in the meaning described in (109b).

- (109) a. *xulca metayelet b-a-vadi.*
 shirt travels in-the-wadi
 'A shirt travels the wadi.'
- b. *xulca metayelet b-a-vadi.*
 was.rescued hiker[Fem] in-the-wadi
 'A (female) hiker was rescued in the wadi.'

This reanalysis involves two categorical changes - *xulca* changes from a noun (*shirt*) to a verb (*was.rescued*), and *metayelet* changes from a verb (*travels*) to a noun (*female hiker*). Yet, a categorical change on its own is not sufficient to cause a garden path effect, as can be seen from the examples below:

- (110) a. _{OK}The building blocks are red.
 b. _{OK}The building blocks the sun.
 -Milne (1982)

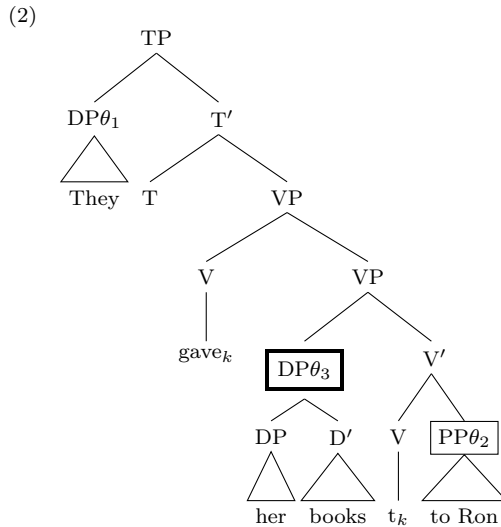

As can be seen in the above structure, the Target *c*-commands the Source, so the proposal provided by Siloni (2004) can still account for the easiness of this reanalysis.

Similarly, in section 4.1.2, we have seen that the OLLC can also account for the easy parsing of sentence (104), as the source position governs the target position. We have considered the double object construction as presented in Pritchett (1992). The OLLC can account for this reanalysis also when assuming VP-shell construction, as the source position governs the target position.

²⁶Siloni (2004) notes that the parser probably pursues (109a) first since 'subject verb' order is more frequent in Modern Hebrew. She also mentions that an alternative explanation would be that *xulca* is more frequent as a noun than as a verb. This issue is not of relevance for our discussion.

- (111) a. OKI saw her duck fly away.
 b. OKI saw her duck into an alleyway.
 -Pritchett (1992)

In (110a), *blocks* is analyzed as a noun, and in (110b) it is analyzed as a verb. Similarly, while in (111a), *duck* is analyzed as a noun, in (111b) it is analyzed as a verb. Neither of these sentences cause a garden path effect.

- (112) **Observation:** A categorical change is not sufficient to cause processing breakdown.

With (112) in mind, let us consider more closely the reanalysis performed while parsing (108). As mentioned above, the parser first pursues the parse in (109a), that is, the following structure:²⁷

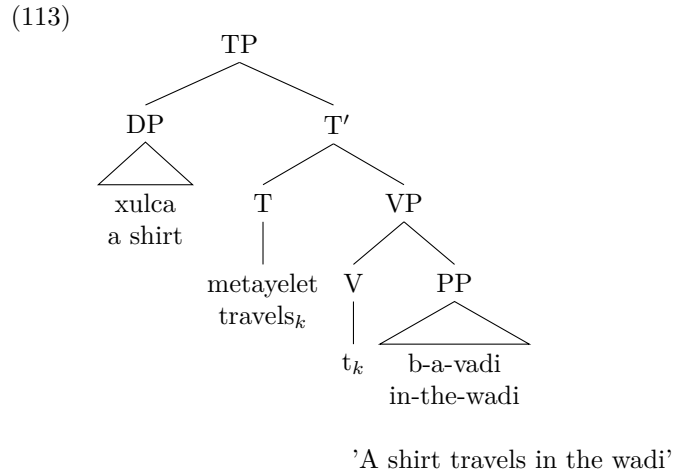

Following reanalysis, the parser yields the interpretation in (109b), by constructing the following structure:

²⁷In Modern Hebrew, verb movement from V to T is attested. Siloni (2004) also shows that (108) is correctly predicted to cause a processing breakdown under her assumptions without assuming that the verb moves from V to T.

(114)

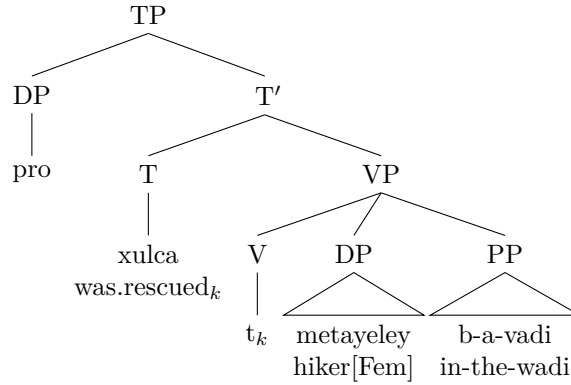

'A (female) hiker was rescued in the wadi.'

The above reanalysis involves relocation of two different elements. We will discuss each of them in turn. The first is that of *xulca*, which is relocated from the subject position to T, as can be seen in (115) below.

(115)

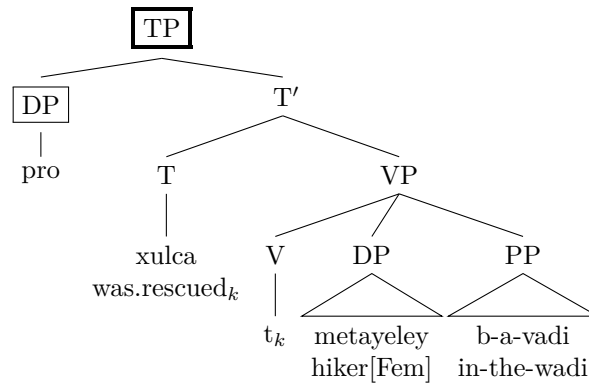

Note that the Target, as defined in (102c), refers to the “maximal projection of α in its new merger” - that is, TP. Since the Target, TP, does not c-command the Source (the DP in the subject position), this relocation is not licit and a garden path effect is correctly predicted.

We shall now consider the relocation of *metayelet*, marked in (116):

(116)

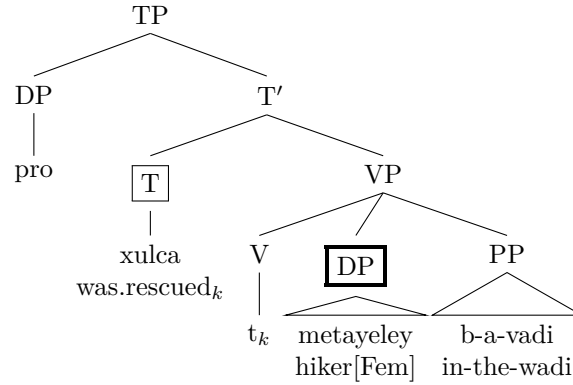

This relocation is also predicted by Siloni (2004) to result in a processing breakdown. That is, *metayelet* is relocated from its source position (T) to the position of the complement of the verb. The Target does not c-command the Source, hence the sentence is (again) predicted to yield a garden path effect.

The proposal described in Siloni (2004) also makes the right prediction regarding a sentence that is falsely predicted to result in a garden path effect under the OLLC or Structural Determinism - sentence (49) repeated below as (117):

- (117) _{OK}Nakamura-ga tyuuko-no pasokon-o katta toki
Nakamura-NOM second-hand PC-ACC bought when
syuuri-site-kureta.
repaired(for-me)
'Nakamura_i, when (I_j) bought a second-hand PC, repaired (it) for me_j.'

I have described the processing of this sentence in detail, assuming Theta Attachment, in section 4.1.4. Now, let us reconsider the crucial point in parsing, under the reanalysis by movement hypothesis. When the parser encounters *when*, the following CP has been constructed:

(118)

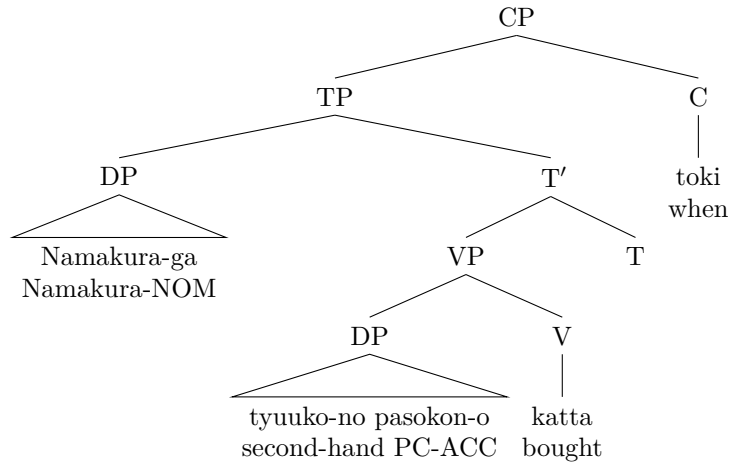

'When Nakamura bought a second-hand PC'

When the parser encounters *repaired(for-me)*, a reanalysis must occur, yielding the following structure:

(119)

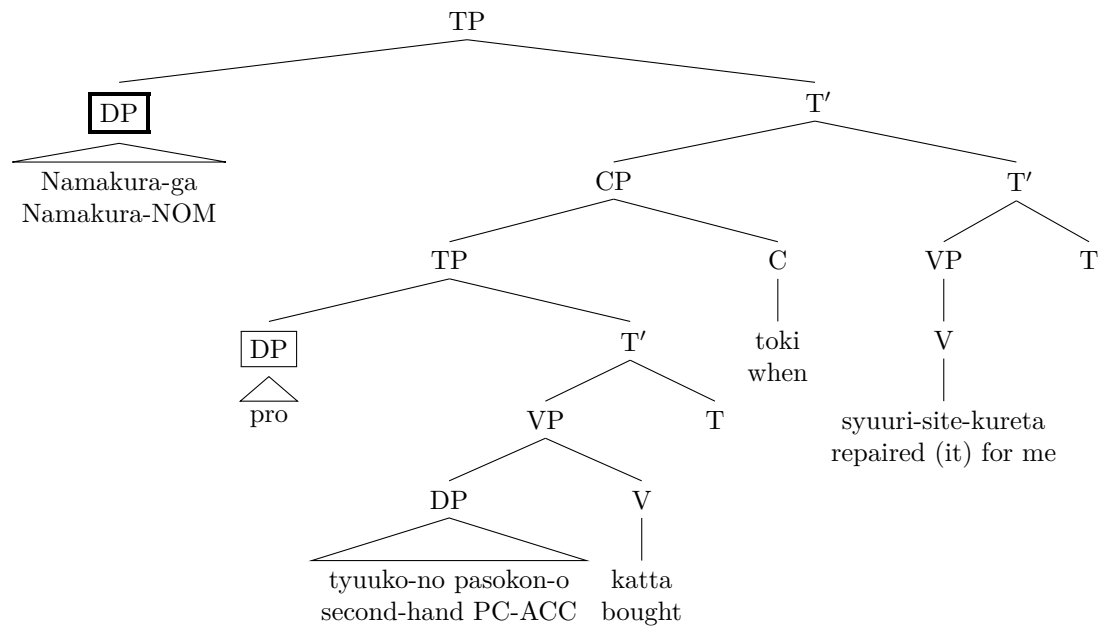

'Nakamura_i, when (I_j) bought a second-hand PC, repaired (it) for me_j.'

Nakamura has been relocated from the subject position of the adjunct to the subject position of the matrix clause. As explained in section 4.1.4, the source

position neither governs nor dominates the target position. Thus, the OLLC wrongly predicts that this reanalysis yield a garden path effect. Moreover, as discussed in detail in section 4.2.4, this reanalysis also violates Structural Determinism and is thus predicted to yield a garden path effect.

Yet, reanalysis by movement (Siloni (2004)) predicts that such reanalysis, as demonstrated in the parsing of (117) above, does not result in a processing breakdown. The Target (the subject position of the matrix clause) *c*-commands the Source (the subject position of the adjunct).

We shall now consider a sentence, taken from Siloni (2004), that does result in a garden path effect:

(120) $_{CP}$ John told the policeman that he stopped to leave.

Let us consider the analysis of (120). At first, the parser encounters *John* and stores it. The initial structure is built when *told* is encountered, assigning its external theta role to *John*. Later, *the policeman* is reached, and merged into the structure, being assigned the first internal theta role of *told*. At this stage, the structure is as follows:

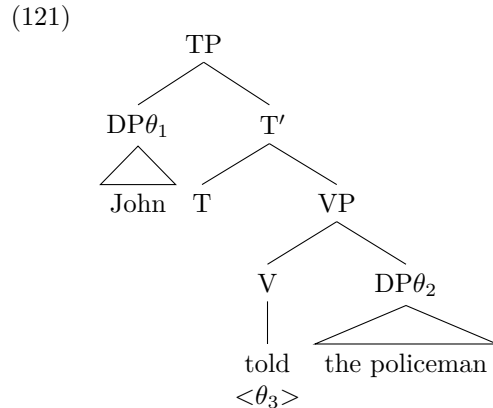

Now, the parser reaches *that he stopped*, and has two alternatives. First, it can assign *told*'s remaining theta role to this CP, taking it to be a sentential complement. In this case, the theta criterion is satisfied. Second, the parser can regard this CP as a relative clause modifying *the policeman* (that is, 'the policeman whom John stopped'). Under this analysis, *told* still hasn't assigned its third theta role, and thus the theta criterion is not satisfied. Consequently, according to Theta Attachment, as well as the definition of Merge in (95), the parser pursues the first option - namely, attaching $_{CP}$ [that he stopped] as a sentential complement of *told*. This results in the following structure:

(122)

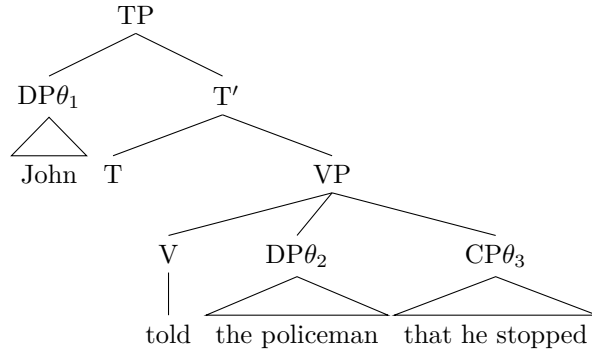

At this point, the parser encounters *to leave*, and the above analysis must be revised in order to assign this CP a theta role. The reanalysis involves relocating CP [that he stopped] from the complement position, and attaching it as a relative clause modifying *the policeman*:

(123)

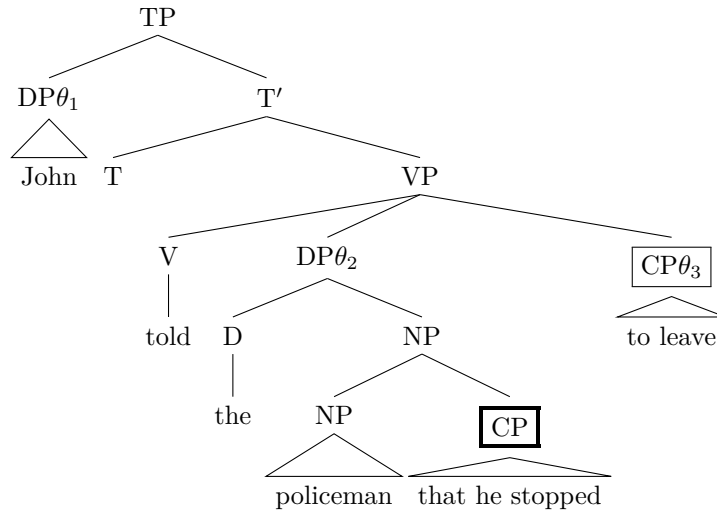

In the above reanalysis, the Target does not c-command the Source. Consequently, an unconscious reanalysis cannot occur, and a garden path effect is sensed, as predicted by Siloni (2004).

4.3.3 Issues with reanalysis by movement

So far we have seen both examples of sentences that are correctly predicted to cause a processing breakdown, and sentences that are correctly predicted not to cause a garden path effect under the proposal made by Siloni (2004). Now, we shall examine a case where Siloni's (2004) predictions turn out to be wrong.

Let us reconsider (52), repeated below as (124):

- (124) _{GP}Yoko-ga kodomo-o koosaten-de mikaketa takusii-ni noseta.
 Yoko-NOM child-ACC intersection-LOC saw taxi-DAT put-on
 'Yoko put the child on the taxi she saw at the intersection.'

I discussed the processing of this sentence in section 4.1.4. As explained there, the parser first encounters *Yoko*, and is assumed to store it (both according to Pritchett (1992) and Siloni (2004)). Same applies for *the child* and *intersection*. Then, when the verb *saw* is encountered, the following structure can be built:

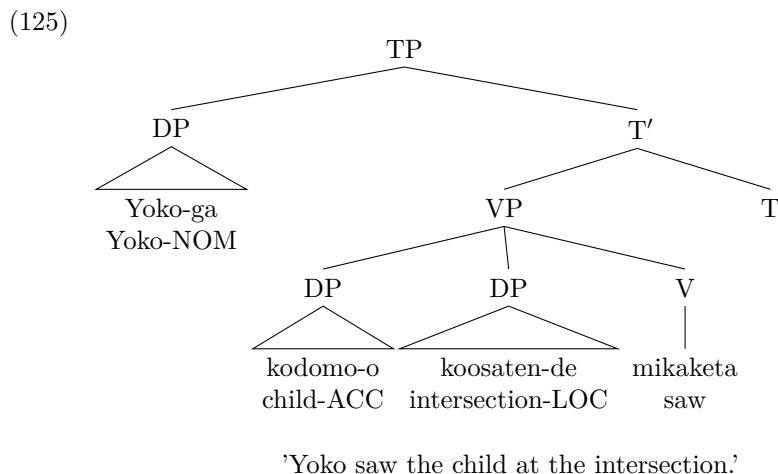

When the parser encounters the non theta-assigner, *taxi*, a reanalysis is necessary - namely, changing the original matrix clause to a relative clause. As mentioned in in section 4.1.4, *taxi* cannot be assigned the external thematic role of *saw*, and thus the relative clause is an object relative - that is, 'the taxi that she saw at the intersection'.

As a result, the reanalysis at this points yields three distinct DP elements - *Yoko*, *the child*, and *the taxi she saw at the intersection*. Since no theta assigner for either of these elements has been encountered, the rebuffering mechanism must be used, sending these elements to the store. At this point, the store should include these elements as follows:

(126)

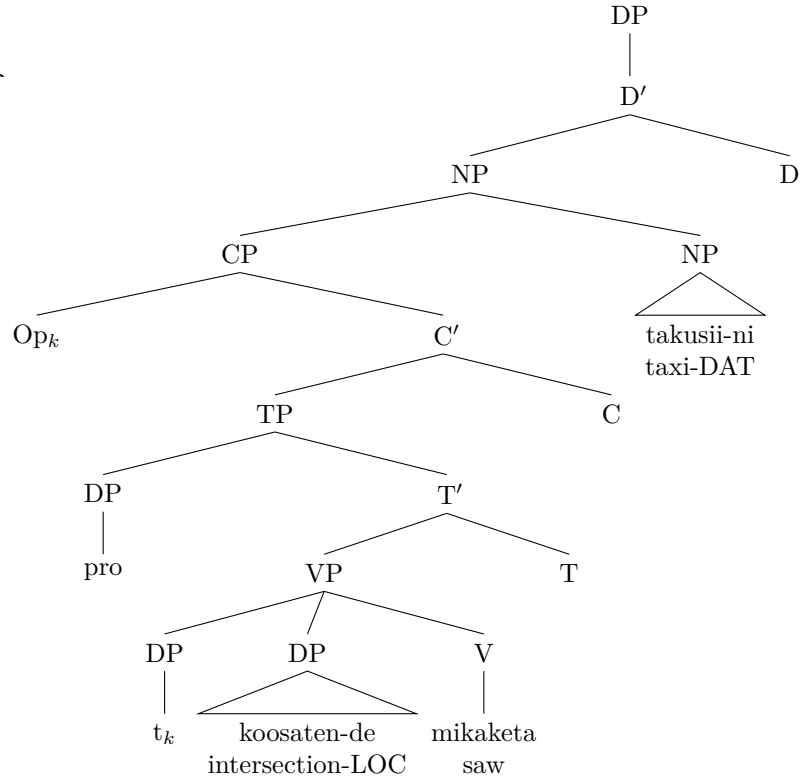
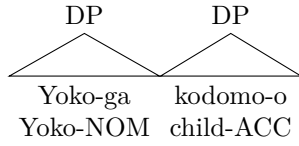

'Yoko; the child; the taxi she saw at the intersection.'

Assuming that the parser can rely on the rebuffering mechanism, as Siloni (2004) does, we predict that when the parser encounters the matrix verb (*put-on*), it should be able to place all the arguments from within the store into the structure without difficulty. Yet, this sentence yields a processing breakdown.

One might suggest that the rebuffering mechanism per se is problematic, but another problem arises if we do not assume that it is the rebuffering mechanism which “saves” this sentence from yielding a garden path effect. Consider the final structure of this sentence:

(127)

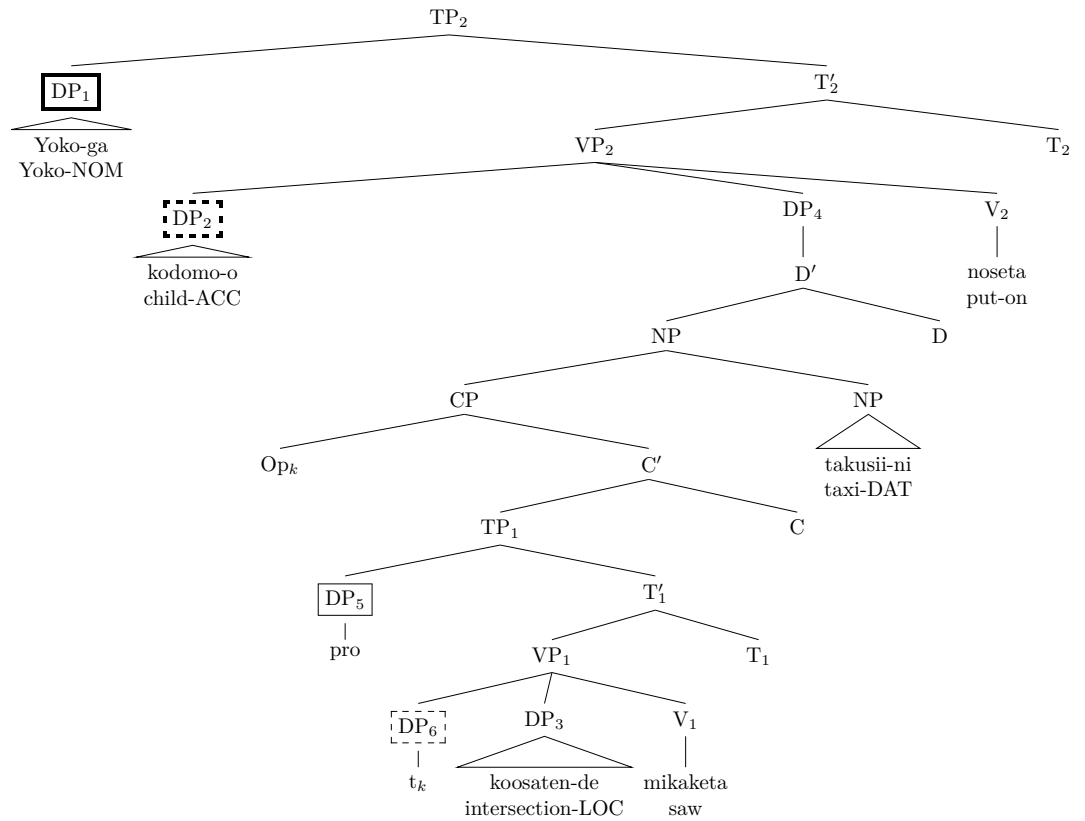

'Yoko put the child on the taxi she saw at the intersection.'

The reanalysis above involves relocations of two elements, and both are permitted according to the reanalysis by movement presented in Siloni (2004). One change involves relocating *Yoko* from the complemented subject position (marked with a box), to the matrix subject position (marked with a bold box). Since the Target (matrix subject position) *c*-commands the Source (subordinate subject position), this relocation is assumed not to cause any processing difficulty. Similarly, the relocation of *child* is also allowed, since the Target (marked in a bold dashed box - the complement position of the matrix verb, *put-on*) *c*-commands the Source (marked in a dashed box - the complement of the subordinate verb, *saw*). As both relocations are permitted according to Siloni (2004), this sentence is predicted to be easily parsed. Yet, as noted above, it does result in a garden path effect.²⁸

²⁸As mentioned in section 4.2.4, this sentence is well accounted for under Structural Determinism.

4.4 Interim Summary

In section 2, we have reviewed the phenomenon of garden path and raised two main questions regarding it in (6), repeated below as (128):

- (128) a. When facing an ambiguous segment, which analysis does the parser pursue?
b. When a reanalysis is required, when will it result in a garden path effect?

In section 3, we reviewed the Theta Attachment principle suggested by Pritchett (1992), as a possible explanation for (128a).

Later, in section 4, we considered the question posed in (128b). We reviewed three different proposals that had been suggested in the literature - OLLC suggested by Pritchett (1992), Structural Determinism as in Gorrell (1995), and reanalysis by movement as proposed by Siloni (2004). We considered counterexamples for each proposal, that is, cases where it fails to account for the data.

In the next section, we shall consider a crucial part of the parser - its incremental nature. After that, in section 6, I shall provide my own suggestion - describing my assumptions regarding the parser, and provide possible answers to both questions posited in (128).

5 Incremental Parsing

As Sturt & Crocker (1996) explain, “the mere existence of garden path phenomena shows that the human parser is incremental in the sense that it does not wait for disambiguating information before committing itself to an analysis of a locally ambiguous material.” Many researchers agree that the parser is incremental, and provide various possible motivations. For example, Weinberg (1993) argues that “the incremental satisfaction of licensing constraints, particularly the Theta Criterion, allows the parser to perform incremental semantic interpretation.” However, different proposals differ as to the parser’s strictness level regarding its incremental nature. For example, Theta Attachment as proposed by Pritchett (1992) and described thoroughly in section 3, assumes that the structure is head-driven - that is, the parser waits for a licensing head in order to commit to a specific syntactic analysis. Parsers of this kind are called *head-driven licensing parsers*.

As Bader & Lasser (1994) explain, head-driven licensing parsers have two prominent properties: (a) their syntactic structure is built exclusively from heads in the input string; and (b) every attachment must be licensed by an element in the already existing structure. According to such parsers, for a syntactic structure to be well formed, no principle of the grammar (e.g., binding principles or the theta criterion) may be violated. In addition, each element “must be licensed in one of a small number of available ways” (Chomsky (1986b)). Various “licensing relationships” have been proposed in the literature. For instance,

a phrase can be licensed as an argument of a verb - such licensing relationship is accomplished through the mechanism of theta assignment.

Since theta grids are associated with heads, theta-assigning projections are actually supposed to be licensed by their relationship to a head. Thus, heads carry two types of grammatically relevant information: (a) the categorial features of phrases; and (b) licensing information - like a theta grid. Thus, heads function as licensors for other maximal projections.

Bader & Lasser (1994) state that head-driven licensing parsers are parsers that contain two principles:

- (129) a. **Head Projection (HP)**: Build a maximal phrase if its head has been encountered in the input.
- b. **Attachment by Licensing (AbL)**: Attach a phrase into the current tree when it is licensed by an element in the current tree.

According to the above principles, HP determines how and when categorial information is used to project phrases, while AbL determines how and when selectional information is used in attachment decisions. A core assumption that head-driven licensing parsers make is that both structure building and attachment actions are input driven. Crucially, as Bader & Lasser (1994) state, “[...] HP determines that only heads in the input string can initiate the building of new structure, and, according to AbL, attachment of a phrase occurs only when it is licensed by an element in the already existing structure”. Note, that a parser obeying HP cannot hypothesize a new phrase prior to the appearance of its head in the input.

The parser proposed by Pritchett is of this kind. In Pritchett (1991), he explicitly states that “a node cannot be projected before the occurrence of its head”. That is, under Theta Attachment, an argument cannot be attached to the structure until its theta-assigning head has been encountered. Other researchers have made similar claims, including Frazier & Rayner (1982), Abney (1987, 1989), Weinberg (1995), Stevenson (1998) and Mulders (2002). Siloni (2004) has also relied on these assumptions. Recently, Mobbs (2015) suggested a head-driven parser, claiming that “there is a significant empirical basis for supposing a head-driven [...] parsing algorithm”. Similarly, Gerth (2015) implemented a minimalist head-driven licensing parser, “so that the attachment of pre-head constituents is postponed until the head arrives”. Under head-driven licensing parsers, in head-final languages such as Japanese or Korean, the parser waits until reaching the final word of a phrase prior to constructing the structure for that phrase.

Other researchers, such as Gorrell (1995) and Sturt & Crocker (1996), do not assume that structure building is licensed by heads. Gorrell (1995) states that structure building is driven by Incremental Licensing, as defined below:

- (130) **Incremental Licensing**: The parser attempts incrementally to satisfy principles of grammar.
 -Gorrell (1995), (7a)

Yet, as noted by Sturt & Crocker (1996), Gorrell (1995) does not explicitly specify “whether the parser should be allowed to buffer constituents”. Sturt & Crocker (1996) have taken a very constrained approach, according to which each word has to be incorporated within the structure as it is encountered. They define the following principle:

- (131) **Strict Incrementality:** Each word must be connected to the current tree description at the point at which it is encountered through the addition of a non-empty set of relations to the description.
 -Sturt & Crocker (1996), Chapter 3, (1)

We shall now review evidence against the notion of head-driven licensing parsers, and in favor of a parser which strives for incremental licensing.

5.1 Evidence from Garden Path sentences

In section 4.1.4, we have considered (52), a case where the rebuffering mechanism is incorrectly predicted to “save” some sentences from yielding a garden path effect. As the rebuffering mechanism relies on head-driven licensing, and can only occur if the parser encounters an argument that cannot be licensed by a head (specifically by assignment of a theta role or modification relations), 52 should not result in a garden path effect when processed by a head-driven licensing parser (as discussed in section 4.1.4). However, it is also possible that there is some additional constraint on the rebuffering mechanism itself,²⁹ which causes the garden path effect in these sentences. Therefore, I would like to address a few sentences which are predicted not to cause processing difficulty by any head-driven licensing parser (regardless of a rebuffering mechanism), but actually result in processing breakdown.

Recall the Korean garden path sentence (80b) taken from Suh (2005), and repeated below as (132):

- (132) _{GP}Kiho-nun Mina-eykey Yumi-ka ecey sokayhayssta
 Kiho-TOP Mina-DAT Yumi-NOM yesterday introduced
 ‘As for Kiho, Yumi introduced him to Mina yesterday.’

Let us consider the processing of sentence (132) again, this time assuming a head-driven licensing parser, for example - a parser employing Theta Attachment. When the parser encounters *Kiho*, it sends this DP to the store, as no theta assigner can assign a thematic role to it. Similarly, *Mina* and *Yumi* are sent to the store as well. When *yesterday* is encountered, it is also sent to the store - as it cannot be attached to the structure, since no structure has been projected. That is, a VP node cannot be projected until its head (V) has been encountered (according to HP), and thus the adverbial phrase cannot be attached to the structure. Consequently, in this stage of parsing, there are four elements in the store - *Kiho*, *Mina*, *Yumi* and *yesterday*.

²⁹For an account which poses constraints on the rebuffering mechanism, see Mulders (2002).

At this point, the parser encounters the verb - *introduced*. Theoretically, the parser has two options at this point. The first, is to construct the following structure:

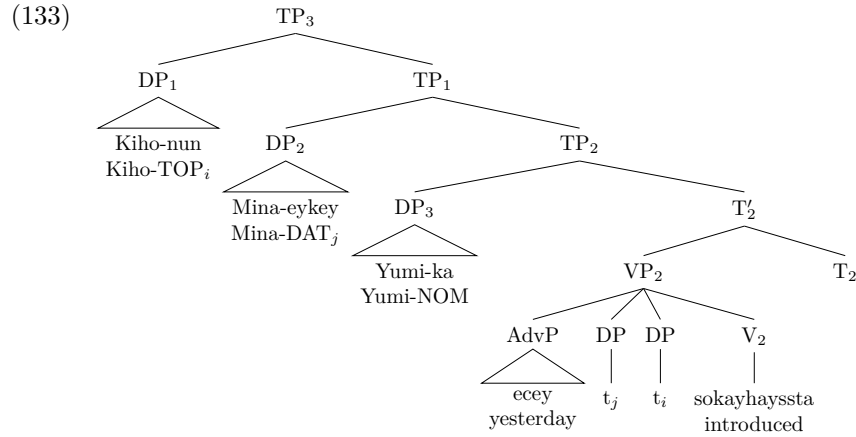

'As for Kiho, Yumi introduced him to Mina yesterday.'

In the above structure, the theta criterion is fully satisfied. That is, *introduced* assigns its external thematic role to *Yumi*, its first internal role to *Kiho* and its third thematic role to *Mina*. All arguments receive a thematic role. If the parser pursues this analysis, the processing is finished and a grammatical structure has been computed successfully, so no garden path effect should occur.

The second option is to construct the following structure:

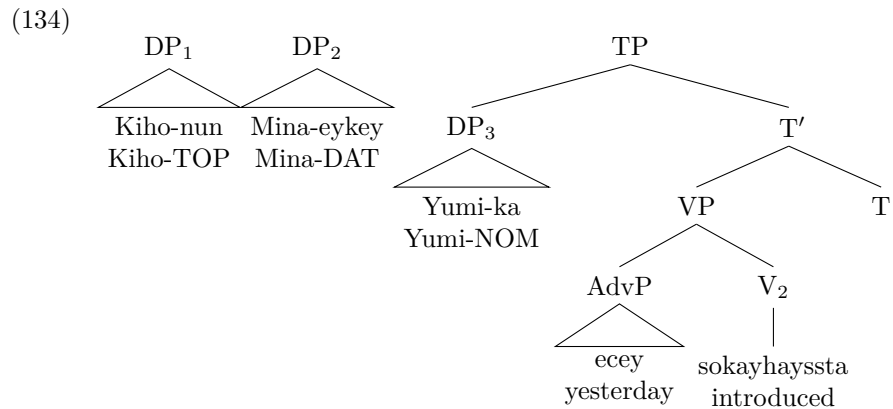

'Kiho; Mina; Yumi introduced'

Here the parser assigns the verb's external thematic role to *Yumi*, yet its two internal roles remain unassigned. That is, *Kiho* and *Mina* are arguments that have not received a theta role and therefore remain in the store. Hence,

a parser employing Theta Attachment clearly favors the structure depicted in (133) over the one shown in (134). As a result, the prediction is that the parser will pursue the analysis shown in (133), and the sentence will be processed without difficulty. However, this sentence results in a processing breakdown, contradictory to this prediction.

This fact does not stem from any rebuffering mechanism, but by the pure nature of head-driven licensing parsers. If the parser does not build any structure prior to the occurrence of the verb, there is no reason for it to prefer (134) over (133), as the latter satisfies Theta Attachment. Once the verb is encountered, the parser has all the information needed in order to construct the right structure. Thus, the fact that sentence (132) yields a garden path effect contradicts the predictions made by any head-driven licensing parser. In fact, according to head-driven licensing parsers, no reanalysis is needed in the processing of (132).

We shall now consider a German example that causes a garden path effect, contrary to the prediction of a head-driven licensing parser.

The significance of head projection and attachment by licensing can be well seen in German if we consider the projection of a VP clause. Assuming HP, no satellites of VP (arguments or adjuncts) can be attached to that VP before the occurrence of V. Bader & Lasser (1994) have conducted a self-paced reading experiment, using German embedded clauses, where the verb appears at the end of the clause, in order to investigate the predictions made by head-driven licensing parsers.

For instance, Bader & Lasser (1994) used the following set:

- (135) a. _{OK}daß sie nach dem Ergebnis zu fragen tatsächlich erlaubt hat
that she/her for the result to ask indeed permitted
has
'that she indeed has permitted to ask for the result'
- b. _{GP}daß sie nach dem Ergebnis zu fragen tatsächlich erlaubt
that she/her for the result to ask indeed permitted
worden ist
has been
'that to ask her for the result has been permitted'
- c. _{OK}daß er nach dem Ergebnis zu fragen tatsächlich erlaubt hat
that he for the result to ask indeed permitted has
'that he indeed has permitted to ask for the result'
- d. _{OK}daß ihn nach dem Ergebnis zu fragen tatsächlich erlaubt
that him for the result to ask indeed permitted
worden ist
has been
'that to ask him for the result has been permitted'

The above sentences are not complete, as they must be preceded by a matrix clause (such as *Peter said that...*). Note that sentences of the above kind are

fully acceptable in German, despite being syntactically complex (as they include two levels of embedding). According to Bader & Lasser (1994), “they may be part of a somewhat formal register, but their grammatical status is in no way marginal”.

Importantly, the feminine singular pronoun *sie* in German is ambiguous between nominative and accusative Case. Consequently, when the parser reaches the word *sie* in the clauses in (135a) or (135b), it faces a local ambiguity that might not be resolved until the end of the clause. The temporary ambiguity concerns whether the ambiguous *sie* is given the accusative reading, analyzed as the object of the first verb *to ask*, or the nominative reading, analyzed as the subject of the second verb *permitted*. In (135), the ambiguity is resolved by the appearance of the auxiliary at the end of the clause. That is, when the auxiliary verb is *has*, the nominative reading turns out to be the correct one, as *has* (*'hat'*) can only agree with *sie* as the active subject of the permitting action expressed by *permitted*. However, in case the auxiliary is *has been* (*'worden ist'*), the sentence is in the passive voice and only the accusative reading of *sie* as the object of *to ask* is valid.

Since the masculine singular pronoun in German is unambiguous between nominative (*er*) and accusative (*ihn*) Cases, (135c) and (135d) do not cause the same temporary ambiguity.

According to head-driven licensing parsers, the ambiguous *sie* should not be attached until a licensing head is encountered. Theoretically, the parser has two options for constructing structure upon encountering the next verb, *to ask*.³⁰ The first option is to attach *sie* in an accusative Case reading as the object of *to ask*, and yield the following CP:

(136)

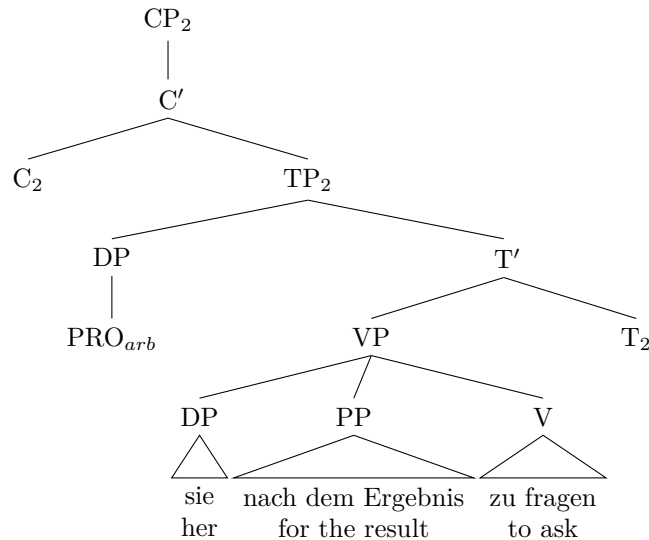

³⁰For example, according to Pritchett’s (1988) Theta Attachment, the parser will attempt to discharge the θ -roles of *to ask*

'to ask her about the result...'

CP_2 is not attached to the structure as a licensing head for it has not been encountered. In Pritchett's (1992) terms, CP_2 is stored as it awaits a thematic role.

The second option is to interpret *sie* in a nominative Case reading. That is, *sie* is not a part of the constructed CP, but rather a different argument, and *to ask* assigns its external θ -role to PRO.³¹

(137)

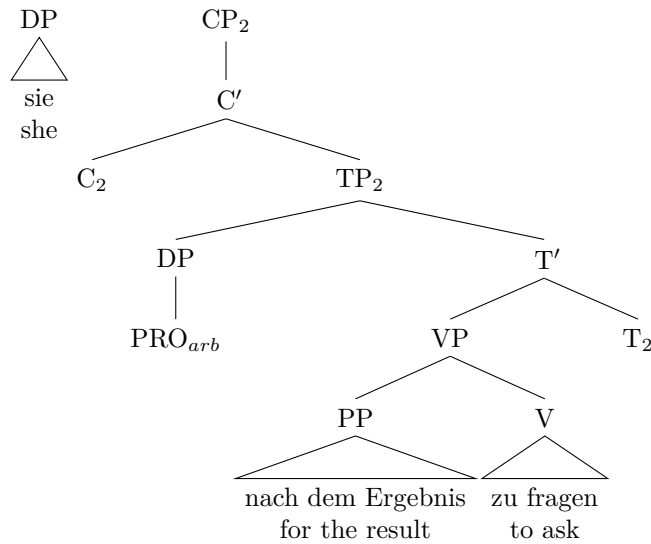

'she; to ask about the result...'

In this option, both DP [she] and CP_2 [to ask about the result] are arguments awaiting a thematic role in the store. Again, any head-driven licensing parser will not attach them to the tree as a licensing head has not yet appeared. Consequently, the parser has two thematic 'debts'. Following Theta Attachment, the parser is liable to prefer the accusative Case reading (that is, the structure shown in (136)). This analysis turns out to be wrong at the end of the clause in the *has* ('hat') condition (135a), while compatible with *has been* ('worden ist') in (135b).³² That is, Theta Attachment fails to predict the garden path effect in (135b).

³¹Note that since *to ask* appears in its infinitival form, *sie* cannot be parsed as its subject.

³²A head-driven licensing parser not employing Theta Attachment might not have a clear preference between (136) and (137), and thus avoid constructing structure until the end of the sentence. When the auxiliary appears, the parser has all the information it needs in order to construct the right structure, and no garden path effect is predicted in either (135a) or (135b). Therefore, both a head-driven licensing parser as described above and Theta Attachment make wrong predictions in this case.

Using the sentences above, Bader & Lasser (1994) advocate parsers employing Strict Incrementality,³³ namely, parsers attaching every element to the parse tree as soon as it is encountered. According to Strict Incrementality, once the parser reaches *sie*, it must be immediately attached. Consequently, *sie* is liable to be attached as the subject,³⁴ so the parser is liable to prefer the subject reading (ending with *has*), and be surprised by the object reading (ending with *has been*), in the ambiguous *sie* conditions. Bader & Lasser (1994) conducted an experiment and reported that German speakers “consistently report confusion” on the object reading condition (that is, conscious difficulty - a garden path effect).

In their experiment, they tested conditions such as those in (135). In order to disqualify a possible explanation that the processing complexity associated with sentences like (135b) is due to their *passive* (versus active) nature, Bader & Lasser (1994) included control conditions using masculine pronouns. They found that subjects took longer to process the ambiguous sentences where the auxiliary reveals that the ambiguous pronoun must be the object of the embedded verb. Yet, this difference did not exist for the unambiguous control. This study provides further evidence against head-driven licensing parsers sentences.³⁵

5.2 Evidence from on-line parsing experiments

In section 5.1, we considered some garden path sentences which provide strong evidence against head-driven licensing parsers, and in favor of incremental parsing. In the past decades, further evidence in this direction has been found from experiments that examine on-line parsing strategies for sentences that do not yield a garden path effect, specifically in head-final languages. For example, Koh (1997) provided evidence supporting processing before the appearance of a head in resolving Dative DPs ambiguity in Korean. Aoshima et al. (2004) demonstrated that the parser postulates a gap in filler-gap constructions before the occurrence of a verb in Japanese. Similarly, Kamide & Mitchell (1999) used both a questionnaire study and a self-paced reading test in order to examine Dative argument attachment in Japanese, and provided evidence that the parser attaches the ambiguous DP prior to appearance of the verb. In addition, Miyamoto (2002) reported that for Japanese, case markers on NPs can allow readers to posit a clause boundary before encountering a verb, and can also facilitate subsequent processing of the verb. On-line parsing experiments from head-initial languages also provide interesting insights. For example, Kush et al. (2017) investigated the processing of pronouns in Strong and Weak Crossover

³³Bader & Lasser (1994) use the term *immediate attachment*. Since the claim is identical to the one made by Sturt & Crocker (1996) when defining Strict Incrementality (as defined in (131)), I shall use the latter term for consistency’s sake.

³⁴This preference is accounted for by the MCP, depicted in section 6.1.

³⁵Konieczny (1996) also tested German embedded clauses, and showed that unambiguously accusative NPs in sentence initial positions are more difficult to process than unambiguous nominative or ambiguous NPs which can be interpreted as nominative. This result also supports the claim that words are attached to the structure before the verb is read, in contrary to head-driven licensing parsers.

constructions in English, and showed that the parser can rule out filler-pronoun binding in Strong Crossover configurations “based on the yet-to-be-seen gap position”. Their results are compatible with parsers that “actively projects a gap position for the filler in advance of a verbal head”, and incompatible with head-driven licensing parsers.

As incremental parsing is only a part of the current proposal, we shall not elaborate on these studies. However, it seems that there is enough evidence to conclude that the hypothesis made by head-driven licensing parsers, that is, HP and AbL as defined in (129), does not match the data. For the parser suggested here, we will adopt the constrained position made by Sturt & Crocker (1996), namely Strict Incrementality.³⁶ Other recently suggested parsers, such as the one suggested by Eshghi et al. (2013), also operate in a strictly incremental manner.

6 The current proposal

In previous sections, we have reviewed the garden path phenomenon and posed two main questions regarding it. Then, we have reviewed various proposals regarding these questions, and demonstrated counterexamples for each proposal, that is, cases where it fails to account for the data, as summarized in section 4.4. Later, in section 5, we claimed that the human parser employs Strict Incrementality.

In this section, I shall describe my own proposal. The structure of this section will be as follows: In section 6.1, I will describe the mechanisms that drive structure building by the parser, and provide a possible answer to question (128a), that is - which analysis the parser pursues when facing an ambiguous segment. Section 6.2 summarizes the conclusions reached in sections 5 and 6.1. In section 6.3 I will describe my answer to question (128b) - namely, what types of reanalysis will result in a garden path effect, and what types will not. In section 6.4, I shall consider different garden-path (and non-garden path) sentences in light of the proposal suggested here in order to examine its validity. In section 6.5 I will examine the consequences of the current proposal regarding phenomena other than garden path. In section 6.6 I will discuss further predictions of the current proposal.

6.1 Structure construction

In section 3, we have reviewed the Theta Attachment principle proposed by Pritchett (1992), as defined in (7) and repeated below:

- (138) **Theta Attachment:** The theta criterion attempts to be satisfied at every point during processing given the maximal theta grid.
-Pritchett (1992), p.12 (23)

³⁶As Sturt & Crocker (1996) note, Strict Incrementality is based on the following hypothesis made by Stabler (1994): “Every structure associated with every prefix of a readily intelligible, grammatical utterance is connected.”

Theta Attachment presupposes that the parser is head-driven. Yet, we have seen in section 5 that a head-driven licensing parser cannot account for the data found in head-final languages.³⁷ In addition, section 3.3 described a case where Theta Attachment makes the wrong predictions in Hebrew, a head-initial language.

Additionally, a theoretical issue arises when considering the way the parser operates if it applies Theta Attachment. At every stage, the parser has to compare alternative analyses with regards to their satisfaction of the theta criterion, and then pick the one that maximally satisfies it. For example, upon encountering *floated* in the sentence “the boat floated down the river sank”, the parser considers both the active and the passive reading of *floated*, and then picks the active one as it maximally satisfies the Theta Attachment. Computing and comparing these different analyses would obviously consume time.³⁸ Yet, the human parser consistently operates in impressive speed.

One way to avoid comparing possible structures at various processing steps, is to have the parser predict ahead in certain circumstances, and then consider only analyses that match the predicted structure. Yet, in many cases the parser cannot predict ahead reliably. I therefore suggest that the parser projects in advance only *licensed* positions. One way to license a position is *lexical licensing*. In this case, I assume the parser to operate as follows:

- (139) **Licensed Lexical Projection:** When a lexical head is encountered, the parser projects the minimal set of nodes that are required to satisfy the head’s lexical requirements.

Licensed Lexical Projection stems from a general principle of grammar,

³⁷Nevertheless, it should be noted that Theta Attachment does make right predictions in some cases involving head-final clauses. Consider, for instance, the following German sentences:

- (1) GP... dass der Entdecker von Amerika erst im 18. Jahrhundert erfahren hat.
 ... that the discoverer of America first in 18th century learned-of has
 ‘...that the discoverer learned of America originally in the 18th century.’
 -Crocker (1990)

When processing (1), the parser first encounters *the discoverer*. Then, the parser reaches *of America*, and has to assign *of America* the thematic role of *the discoverer* in order to comply with Theta Attachment. The option of not assigning *the discoverer’s* thematic role to *of America*, would leave *of America* without a thematic role. This prediction of Theta Attachment matches the fact that (1) yields a garden path effect, since it predicts that a reanalysis will be required upon appearance of the verb. That is, the PP *of America* must be relocated from its position as a complement of *the discoverer*, and be positioned as a complement to the verb, yielding the meaning that ‘*the discoverer learned of America...*’. This reanalysis is correctly predicted by the OLLC, Structural Determinism and reanalysis by movement to result in a garden path effect.

³⁸Comparing multiple analyses is shared by other views as well. For example, in Altmann’s (1988) model, all possible analyses are considered at each step, and only one is pursued. Other approaches, as Gibson’s (1991) mentioned in footnote 1, allows for a few constructions to be pursued in parallel. Other models, as the ones by Stevenson (1994) and MacDonald et al. (1994), allow multiple structures to dynamically compete with each other in the ranking process.

namely the Projection Principle, as defined below:

- (140) **The Projection Principle:** Representations at each syntactic level [...] are projected from the lexicon[...]
-Chomsky (1981)

Consider a simple sentence such as “John bought a book”. Since *bought* is obligatorily transitive, its object position is licensed, and Licensed Lexical Projection states that the parser must project this position. The parser thus computes the structure below:³⁹

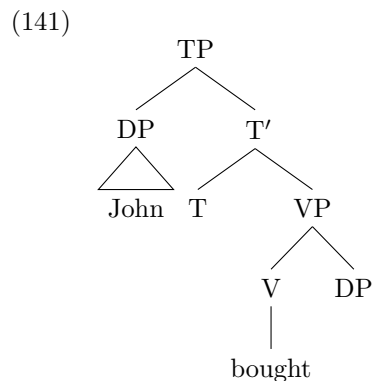

Similarly, when the parser processes a ditransitive verb (such as *give*), I assume that the parser computes a VP-shell.⁴⁰

The parser can foresee structure in other cases as well. For example, there is no need for lexical information of any specific head in order to tell that TP will be the sister of C, as this is the general phrase structure of the grammar. As Crocker (1995) claims, the parser “predicts ‘obligatory structure’ [...] ‘functionally’ selected, i.e. without regard to lexical information.” I state this as follows:

- (142) **Licensed Functional Projection:** When a functional head is projected, the parser projects its complement.

For example, consider a German subordinate clause starting with the complementizer *that*. Once the complementizer is parsed, it is attached to the C position. Next, according to Licensed Functional Projection, the parser projects C’s complement, TP, and its corresponding head - T.⁴¹ Since T has been projected, the parser also projects its complement, VP, along with its head. The structure is as follows:

³⁹This is in line with Gorrell (1995), who states regarding a similar sentence that the post-verbal DP “has been precomputed by the parser based on the subcategorization requirements of *buy*, which requires an NP object”.

⁴⁰This assumption is also made by Siloni (2004), who states that “a DP object of a ditransitive verb is necessarily mapped first to SpecVP, anticipating a VP-shell” (fn.12).

⁴¹The parser projects a head X iff it projects its maximal projection, XP.

(143)

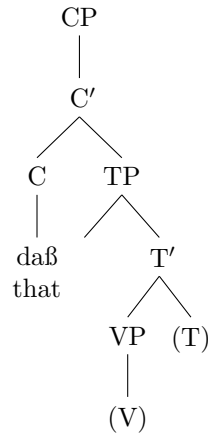

According to the licensing operations above, the parser relies on heads in order to project positions in advance. Crucially, the parser can also attach material to positions that are not yet licensed.⁴² The building operation is guided by three main principles. The first is Strict Incrementality, that is, attaching every element to the current tree structure. The second is predicting and projecting new positions. The third is occupying projected positions.

I suggest that at every step, the parser reads an element from the input, attaches it to the structure, and projects new licensed positions. This is stated as follows:

- (144) **Incremental Projection and Attachment:** at every step, the parser:
- Reads an element from the input.
 - Attaches this element to the structure.
 - Projects new licensed positions (according to Licensed Lexical Projection and Licensed Functional Projection).

While attaching an element to the structure (in (144b)), the parser works in the following order:

- (145) **Order of Attachment:**
- Attach to an empty projected position.
 - Attach within a phrasal unit whose lexical head has been read.
 - Attach to a new argument position whose head has not yet been projected.

Let us demonstrate the parser's operation given the above assumptions by considering (1), repeated below as (146):

- (146) _{CP} While Mary was mending the clock started to chime.

⁴²This contrasts with AbL presented in section 5, which allows attachment only to licensed positions.

When the parser encounters *While*, it is attached as C, triggering the computation of TP and later VP according to Licensed Functional Projection. The resulting structure is presented below:

(147)

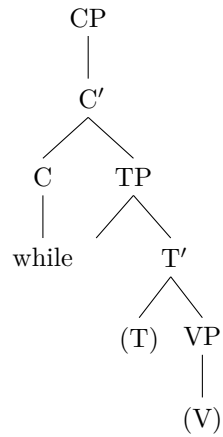

When *Mary* is encountered, it is attached to the empty position projected in [Spec TP] according to Order of Attachment:

(148)

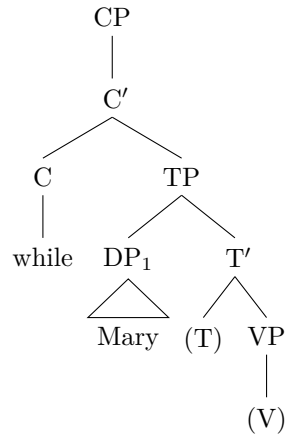

Next, *was* and *mending* are encountered, and placed in their corresponding positions:

(149)

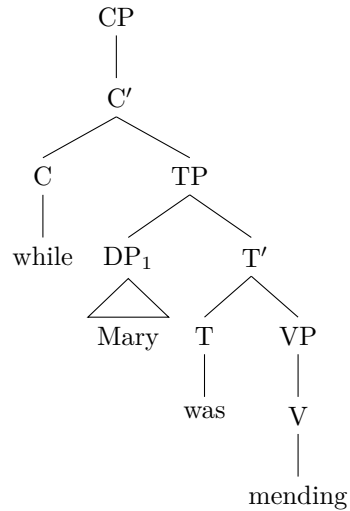

Note that up to this point, the parser does not project an object position for *mending*, complying with Licensed Lexical Projection (as *mend* doesn't have to realize its object syntactically). When the parser encounters *the*, a DP should be projected, and attached to the tree description. As there are no empty projected positions in the structure, the parser moves on according to Order of Attachment and attempts to attach this DP within a phrasal unit whose lexical head has been read.⁴³ In this case, *mending* has been read, and can license a DP complement. Therefore, this DP is attached as *mending*'s argument, and an NP complement is attached to its head according to Licensed Functional Projection:

⁴³This is similar to *Head Attachment* proposed by Konieczny et al. (1991):
Prefer to attach an item to a phrasal unit whose lexical head has already been read.

(150)

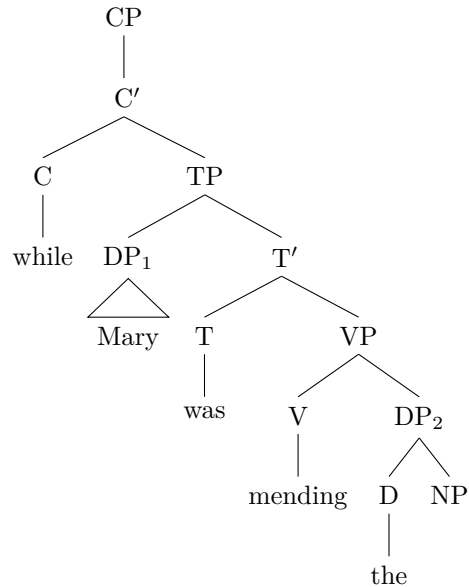

Upon encountering *clock*, it will be attached to the empty NP position. Given the current proposal, the parser attaches DP₂ as *mending*'s complement, without “considering” the alternative, namely to attach it as the subject of a subsequent clause. This correctly predicts the need for reanalysis in (146).

Now, consider (2b) repeated below as (151):

(151) _{OK} While Mary was mending the clock it started chiming.

(151) is identical to (146) up to the occurrence of *it*. I therefore assume the same processing up to this point. Next, *it* is encountered. According to Order of Attachment, the parser would first attempt to attach it to an empty projected position, but no such position exists. The parser would then attempt to attach it within a phrasal unit whose lexical head has been read. This cannot be accomplished, since *mending* does not have a ditransitive realization. Therefore, the parser proceeds to projecting a new argument position, namely a subject position of a subsequent clause, where *it* can be attached:

(152)

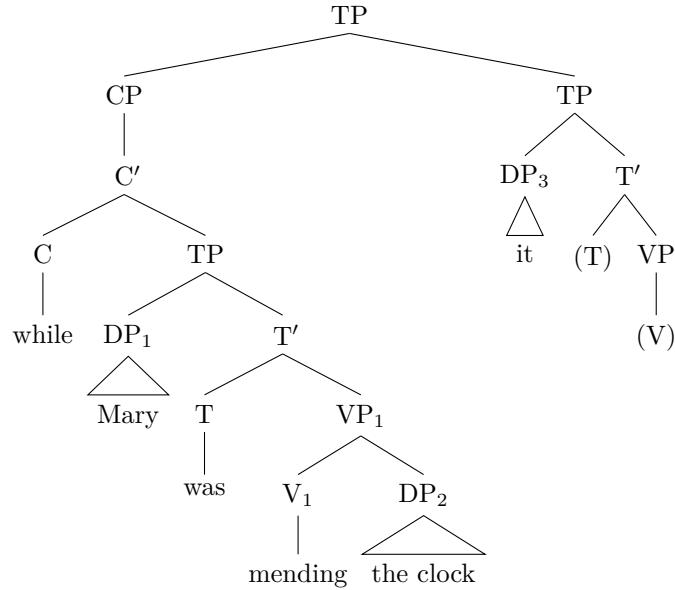

Since a new TP was projected, T, VP, and V have been projected as well (in accordance with Licensed Functional Projection). The rest of the sentence is liable to be attached without reanalysis, which accounts for the easiness of parsing (151).

The contrast between (146) and (151) is also accounted for by Theta Attachment, as explained in section 3.1. Let us now consider a sentence whose consistent garden path effect is not predicted by Theta Attachment (as explained in section 3.3), (23) repeated below as (153):

(153) _{CP}bi-zman še-ra'iti yeled ŠOVR highi'a b-a-do'ar.
in-time that-I.saw boy coupon/breaking arrived in-the-mail
'When I saw a boy, a coupon arrived in the mail.'

Up to the occurrence of ŠOVR, a parser operating as described so far would compute the structure below:

(154)

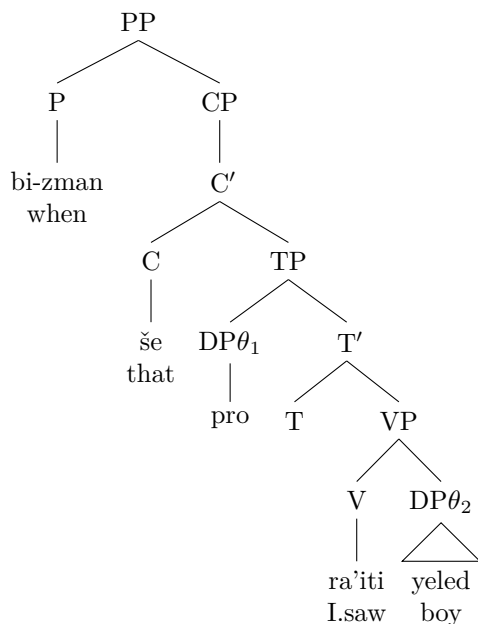

'When I saw a boy...'

As explained in section 3.3, ŠOVR is ambiguous between *a coupon* and *breaking*. According to Order of Attachment, the parser would first attempt to attach ŠOVR to an empty position, if such position existed in the structure. Next, the parser attempts to attach ŠOVR within a phrasal unit whose lexical head has been read. Since ŠOVR cannot be attached to *boy* (by either meaning), it is predicted to be attached within the VP, where only the *breaking* reading is possible, yielding the meaning “When I saw a boy breaking...”. Again, the parser is not assumed to consider the alternative according to which ŠOVR is attached as a subject of a subsequent clause. When the parser encounters *arrived*, a reanalysis will be required, in line with the garden path effect yielded by (153).

The principles suggested above can account for a variety of sentences described in this paper, but not for all of them. Consider sentence (80b), repeated below as (155):

- (155) _{GP}Kiho-nun Mina-eykey Yumi-ka ecey sokayhayssta
Kiho-TOP Mina-DAT Yumi-NOM yesterday introduced
'As for Kiho, Yumi introduced him to Mina yesterday.'

As explained in section 4.2.3, when parsing the above sentence, the parser has two options prior to the occurrence of the verb. The first, is to analyze the Topic-marked element *Kiho* as a base-generated subject, and yield the following structure:

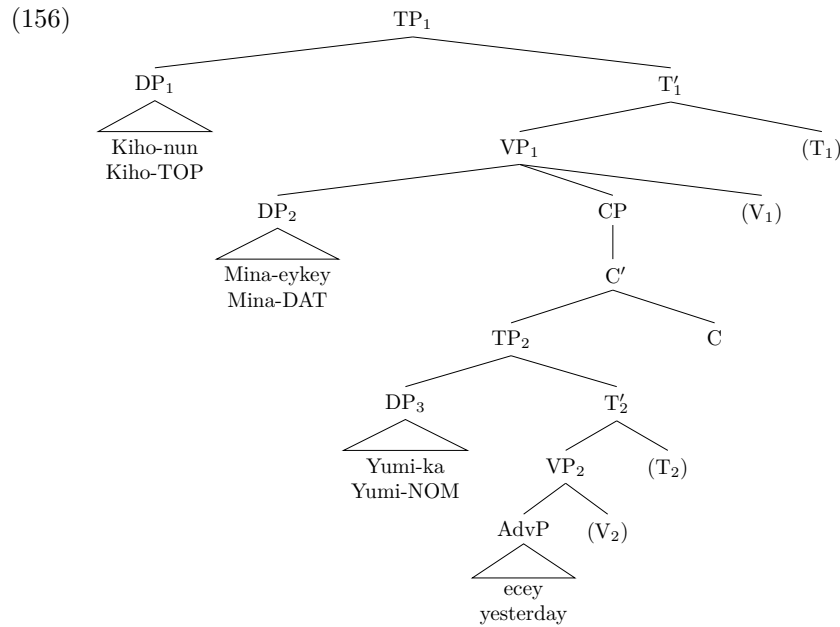

The second, is to consider *Kiho* as a complement, which has undergone syntactic movement. Therefore, the following structure will be generated prior to the occurrence of the verb:

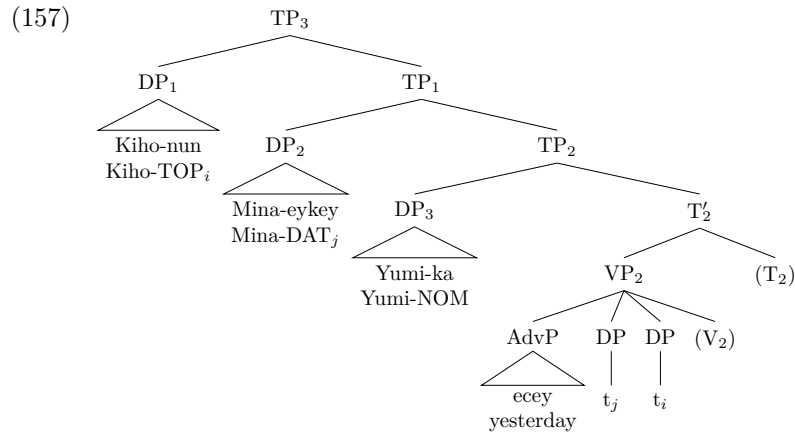

While the structure depicted in (157) is compatible with the continuation of the sentence in (155), (156) is not. Since the processing of (155) yields a garden path effect, our model should predict that the parser prefers the structure in (156) prior to the occurrence of the verb. When the parser encounters *Kiho*, it cannot know for sure whether it will end up as a base-generated, or rather a scrambled subject. Since it is the first word to be inserted, there are no existing projections that it can be attached to. Yet, according to Strict Incrementality, it must be attached to the structure.

We therefore need to add another principle to the parser. In order to account for the processing difficulty in (155), as well as in other cases, I will adopt the Minimal Chain Principle (MCP) as defined in De Vincenzi (1991, 2000):⁴⁴

- (158) **Minimal Chain Principle (MCP):** Postulate required chain members at the earliest point grammatically possible but postulate no potentially unnecessary chain members.

As Suh (2005) explains, MCP is based on “the idea that syntactic chains are costly for short-term memory and hence the parser tries to complete chain computation as soon as possible if there is evidence for the existence of a chain.”

De Vincenzi (2000) mentions that the MCP combines two processing principles that have been proposed in the literature, namely Superstrategy in Fodor (1979), and the Active Filler Hypothesis in Frazier (1987). According to Superstrategy, a string is analyzed as a well-formed deep structure (that is, without syntactic movements), and movement is postulated only as a last resort. Similarly, MCP assumes that an element is first assumed to be generated without movement. However, in case the parser finds evidence for syntactic movement, then it follows the Active Filler Hypothesis - that is, posit a corresponding empty category as soon as the grammar allows it - and thus the chain computation is completed as soon as possible.

As Suh (2005) claims, the MCP makes the right predictions regarding (155) above. While the structure in (157) assumes two movements (that is, two chains) - the structure in (156) does not. Thus, (156) is predicted to be preferred by the parser according to MCP. As mentioned above, this prediction is correct as the structure in (156) turns out to be incompatible with the continuation of the sentence, and a garden path effect is sensed.⁴⁵

Note that given our assumptions so far, together with the MCP, the parser does not wait for a predicate in order to commit to its analysis. Rather, the parser is liable to prefer the base-generated analysis of *Kiho* immediately. That is, upon encountering *Kiho*, the parser can either analyze it as base-generated or scrambled. According to the MCP, the parser will pursue the former analysis. At this point, the following structure will be projected, according to Licensed Functional Projection:

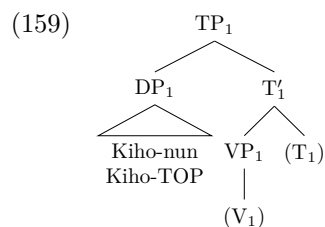

⁴⁴The MCP accounts for the subject preference in sentences (135a) and (135b) described in section 5.1. Suh (2005) provides additional Korean cases that can be accounted for by the MCP. Further evidence from garden path sentences will be provided in section 6.4.2.

⁴⁵The MCP seems to be relevant not only in head-final languages. As a matter of fact, De Vincenzi (2000) claims that the MCP is a universal parsing principle. She demonstrates its validity in a wide range of data from many head-initial European languages.

Upon reading *Mina*, this DP cannot be attached to an empty position, since the only empty positions available are V_1 and T_1 . It can neither be attached within a phrasal unit whose lexical head has been read. Therefore, the parser projects a new argument position, attaching *Mina* under the already-projected VP_1 . Again, the parser assumes *Mina* to be base-generated, complying with the MCP. The structure below is yielded:

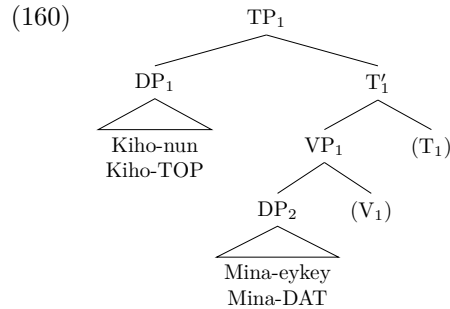

Next, the parser encounters *Yumi*, which is marked with a Nominative case, and should thus be attached to a subject position. The parser projects a new clausal complement position, and attaches *Yumi* as its subject. Consequently, further functionally licensed nodes are projected, resulting in the structure below:

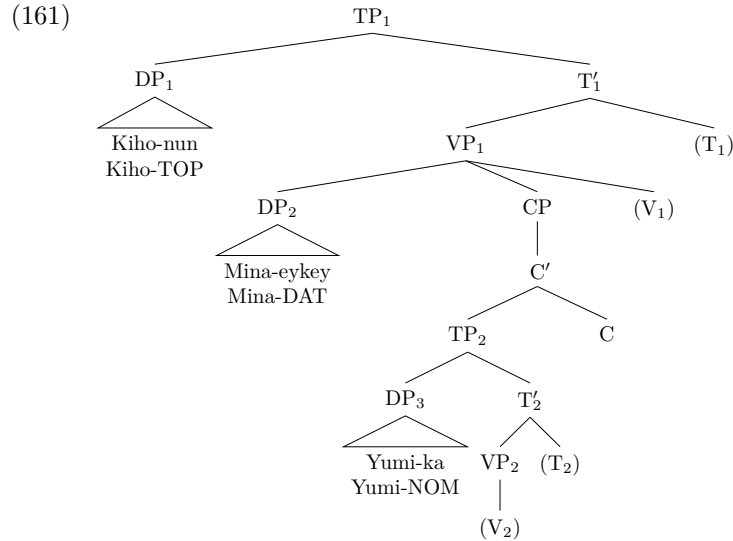

Again, as this analysis is incompatible with (155), the need for reanalysis is predicted correctly.

We shall now consider the processing of (15), introduced in section 3.1 and repeated below as (162), given our assumptions.

(162) $_{GP}$ John told the man that Mary kissed that Bill saw Phil.

The parser first encounters *John*. The only way to grammatically attach it without assuming movement is as a subject. The parser then projects the relevant functionally selected nodes and yields the following structure:

(163)

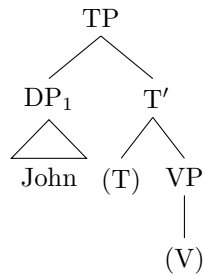

Upon encountering *told*, the parser attaches it to the existing empty projection. According to Licensed Lexical Projection, at this point, the parser projects two internal argument positions:

(164)

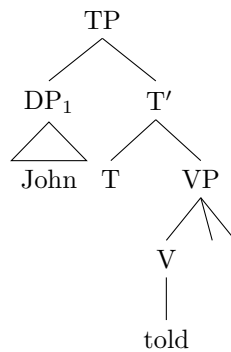

The parser projects a DP upon encountering *the*, and attaches it to the first empty position. Later, the parser attaches $NP[man]$ within this DP.

(165)

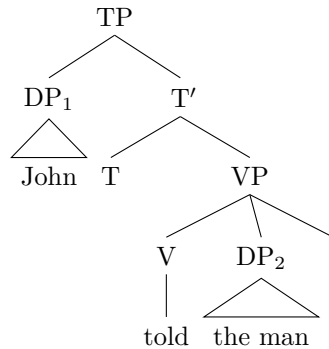

Next, the parser encounters the complementizer *that*, which projects a CP. The parser attempts to attach this CP to the remaining empty position (according to Order of Attachment), and succeeds in doing so as *told* selects a CP complement. This analysis is incompatible with (162), and we therefore correctly predict that a reanalysis will be required.

As explained in section 3.1, Theta Attachment also accounts for the reanalysis in (162). The current proposal accounts for this preference by claiming that the parser has projected two argument positions when encountering *told*, and later strove to occupy these positions. Theta Attachment, on the other hand, claims that the parser attempted to maximally satisfy the theta criterion by assigning *told*'s internal role.

We shall now test the predictions made by Incremental Projection and Attachment combined with Order of Attachment regarding a different phenomenon attested in German:

- (166) Daß Manfred den Mann mit dem Fernglas beobachtete, ...
 That Manfred the.ACC man with the binoculars observed, ...
 'That Manfred observed the man with binoculars, ...'
 -Konieczny et al. (1994)

Considering our assumptions, when the parser reaches *That* in (166), it computes the following structure:

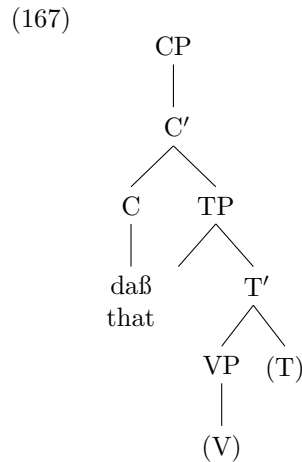

Manfred is attached to the empty subject position. Next, *the man*, marked with Accusative case, is attached as a direct object within the projected VP. The parser has computed the following structure:

(168)

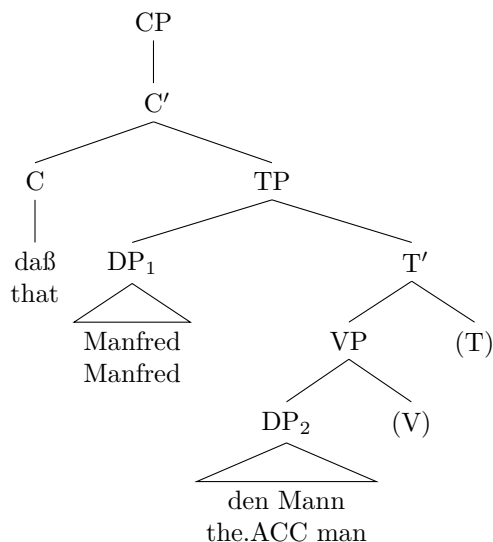

Next, the parser encounters the preposition *with*. This preposition projects a PP, which can be either attached as an additional argument within the VP, or as a modifier of *the man*. The same ambiguity is also attested in some English clauses, such as (3) repeated below:

(169) The burglar stabbed only the guy with the dagger during the night.

(169) is globally ambiguous, as the PP [with the dagger] can either modify the DP [the guy], or attached to the VP [stabbed only the guy]. When encountering this PP (and specifically, its head - *with*) in (169), the parser has already encountered the verb *stabbed*. This verb licenses a PP complement, and thus both options are indeed possible.

In contrast, when encountering the preposition *with* in (166), the parser has not reached the verb, and cannot tell whether it will license a PP argument or not. According to Order of Attachment, since there are no empty projected positions that the parser can attach the PP to, the parser will attach it as a modifier of the DP [the man], rather than an argument (or adjunct) of the verb. Konieczny et al. (1994) confirmed this prediction in a self-paced reading study, where German subjects showed a reliable preference towards attaching the PP to the preceding DP in constructions similar to (166).

This prediction of Order of Attachment is different than predictions made in some other theories. Specifically, Gorrell (1995) states that “argument attachment is structurally simpler and, therefore, preferred.” That is, when facing an element which might turn out to be either an argument or an adjunct, “the parser will not project the (potentially vacuous) intermediate nodes required for adjunct attachment”.⁴⁶ Crocker (1995) also predicts an argument-over-adjunct

⁴⁶This line of thought, where the parser pursues the most simple structure, namely one that

preference. The data presented by Konieczny et al. (1994) supports the predictions of the current proposal, and contradicts those made by Gorrell (1995) and Crocker (1995).

Order of Attachment as defined in (145) leaves some cases underspecified. For example, when encountering *with* in (169), Order of Attachment does not predict whether the parser will attach it as a modifier of DP [the guy], or to the VP [stabbed only the guy]. Similarly, Order of Attachment does not make a clear prediction regarding the PP attachment in the German sentences below:

- (170) a. Manfred beobachtete den Mann mit dem Fernglas.
 Manfred observed the.ACC man with the binoculars.
 'Manfred observed the man with the binoculars.'
- b. Manfred erblickte den Mann mit dem Fernglas.
 Manfred caught-sight the.ACC man with the binoculars.
 'Manfred caught sight of the man with the binoculars.'
- Konieczny et al. (1994)

Since the sentences in (170) consist of matrix clauses, the verb (linearly) precedes its internal arguments.⁴⁷ Therefore, the parser encounters the verb prior to attaching the PP to the structure. Konieczny et al. (1994) reported that subjects preferred to attach the PP [with the binoculars] to the VP when the verb had bias towards taking a PP as a complement as in (170a), but preferred to attach the PP to the preceding DP when the verb only posed a weak expectation of an instrument as in (170b).⁴⁸

These results are in line with the current proposal. Since the parser has no clear preference according to Order of Attachment, a variation is predicted, and it is sensible for other factors (such as lexical biases) to play a role. The results contradict the predictions made by Gorrell (1995), Crocker (1995) and others, who predicted a consistent argument preference.

I assume together with Gorrell (1995) that the parser constructs a phrase-structure tree, which can be described using structural relations (dominance and precedence).⁴⁹ ⁵⁰ I define attaching an element to the tree by adding the

includes the fewest nodes possible, has been suggested by Frazier (1978) and Frazier & Fodor (1978). Specifically, they have suggested the *Minimal Attachment* principle, which claims that the parser attempts to attach new elements to the structure "using the fewest nodes consistent with the wellformedness rules of the grammar." I will not describe these models in detail here. For an in-depth discussion, see section 3.1 in Gorrell (1995), as well as Pritchett (1991), who offers a critical view of *Minimal Attachment*.

⁴⁷In German matrix clauses, verb-second (V2) word order is attested.

⁴⁸Konieczny (1996) tested sentences similar to those in (170), but varied the PP so that its content forced or strongly biased either an attachment to the VP (e.g., "the horse with the new binoculars") or to the DP (e.g., "the horse with the white patch"). She concluded that in case the verb has not been read, the parser prefers attachment to the preceding noun. In case the verb has already been read, "attachment preferences depend on the detailed subcategorization preferences of the respective heads".

⁴⁹Some researchers assume that the parser has another form of representation, such as a reduced phrase marker (Lasnik & Kupin (1990)) or a set of structural relations (Barton & Berwick (1985)).

⁵⁰See section 8.3 for discussion regarding the need to include precedence in these relations

relations defining its mother and sisters nodes at the state of attachment.⁵¹
Explicitly:

- (171) **Element Attachment:** Attaching element α to the structure is done by:
- a. Adding the relation $\text{dom}(\beta, \alpha)$, where β is the mother node of α at the state of attachment.
 - b. Adding the relations $\text{prec}(\gamma_i, \alpha)$, for each γ_i that is a sister node of α at the state of attachment.

6.2 Interim Summary

In section 5, we have considered the incremental nature of the parser, and specifically inspected the predictions made by head-driven licensing parsers. We have concluded that the human parser is not a head-driven licensing parser, and adopted Strict Incrementality, as introduced in (131) and repeated below:

- (172) **Strict Incrementality:** Each word must be connected to the current tree description at the point at which it is encountered through the addition of a non-empty set of relations to the description.
-Sturt & Crocker (1996), Chapter 3, (1)

Given a strict incremental parser, in section 6.1 we have considered what drives the parser's structure building.

I claimed that the parser projects positions in advanced, but only *licensed* positions. One way to license a position is *lexical licensing*:

- (173) **Licensed Lexical Projection:** When a lexical head is encountered, the parser projects the minimal set of nodes that are required to satisfy the head's lexical requirements.

The parser may also project nodes by Licensed Functional Projection:

- (174) **Licensed Functional Projection:** When a functional head is projected, the parser projects its complement.

I have stated that the parser operates as defined in (144) and repeated below:

- (175) **Incremental Projection and Attachment:** at every step, the parser:
- a. Reads an element from the input.
 - b. Attaches this element to the structure.
 - c. Projects new licensed positions (according to Licensed Lexical Projection and Licensed Functional Projection).

While attaching an element to the structure, the parser works in the following order:

⁵¹This is similar to the definition of *local relations* by Sturt & Crocker (1996), fn. 12: ("The 'local relations' in which a node N participates at state S are those dominance and precedence relations which define the mother and sisters of N at S").

- (176) **Order of Attachment:**
- a. Attach to an empty projected position.
 - b. Attach within a phrasal unit whose lexical head has been read.
 - c. Attach to a new argument position whose head has not yet been projected.

In cases where multiple alternatives are equal with regards to Order of Attachment, variation is predicted and other factors such as lexical preferences can affect attachment preferences.

I have also demonstrated that the parser follows the MCP introduced by De Vincenzi (1991, 2000):

- (177) **Minimal Chain Principle (MCP):** Postulate required chain members at the earliest point grammatically possible but postulate no potentially unnecessary chain members.

With all of the above conclusions, we have provided an answer to the first of two questions originally posed in (6) in section 2, repeated below as (178):

- (178) a. When facing an ambiguous segment, which analysis does the parser pursue?
- b. When a reanalysis is required, when will it result in a garden path effect?

Next, in section 6.3, I will describe my answer to the question posited in (178b). Afterwards, in sections 6.4 and 6.5, I shall consider various sentences and phenomena in light of the current proposal in order to examine its validity.

6.3 Reanalysis and constraints

In section 6.2, we have summarized our assumptions regarding the parser, that provide an answer for the question posited in (178a). In this section, I will suggest my answer for question (178b) - that is, what types of reanalysis yield a garden path effect.

Let us recall observation (94) made in section 4.2.4, and repeated below:

- (179) **Observation:** When Structural Determinism is maintained during reanalysis, the reanalysis does not result in a processing breakdown.

Yet, as seen in section 4.2.4, some sentences which are easy to process violate Structural Determinism, and are thus wrongly predicted to yield a garden path effect. Therefore, a refinement of Structural Determinism is necessary. I suggest the following principle, based on Siloni's (2004) observation that when the Target c-commands the Source, there is no garden path effect:

- (180) **Unconscious Deletion (UD):** A structural relation $R(\alpha, \beta)$ is deleted iff the position of β after reanalysis c-commands its position prior to reanalysis.

A relation R can be a dominance or a precedence relation. For example, $R(\alpha, \beta)$ may be $\text{dom}(\text{VP}_1, \text{DP}_1)$.

In addition, I explicitly state when a garden path effect will be sensed:

- (181) **Condition on Description Validity (CDV):** A garden path effect is sensed iff a relation in the tree description is invalid.

Note that if a relation has been deleted according to Unconscious Deletion, then it is no longer included in the tree description. Hence, falsifying a relation that has been deleted does not result in a garden path effect according to (181).

Unconscious Deletion and the Condition on Description Validity as defined above provide a constraint that is less strict than Structural Determinism. That is, according to UD, an existing relation can indeed be deleted from the tree-description. Yet, this deletion is very much limited. This assumption allows us to preserve the observation made in (179) - if Structural Determinism is preserved, that is - no relation is erased, then the sentence is liable to be processed without resulting in a breakdown. Thus, all sentences that were correctly predicted to be easy to process under Structural Determinism, are still predicted not to result in a garden path effect.

Let us now consider a Japanese sentence that is wrongly predicted to yield a processing breakdown under Structural Determinism, (49) repeated below as (182).⁵²

- (182) OK Nakamura-ga tyuuko-no pasokon-o katta toki
 Nakamura-NOM second-hand PC-ACC bought when
 syuuri-site-kureta.
 repaired(for-me)
 'Nakamura_i, when (I_j) bought a second-hand PC, repaired (it) for me_j.'

The processing of the sentence above has been thoroughly discussed in sections 4.1.4 and 4.2.4. In section 4.3.2, we showed that it is correctly predicted to be easily parsed under Siloni's (2004) reanalysis by movement. Let us shortly review the processing of this sentence again, this time following the assumptions summarized in section 6.2. By the time the parser encounters *bought*, the following clause will be constructed - '*Nakamura bought a second-hand PC*'. Then, *when* is encountered, and thus a *CP* is constructed as follows:

⁵²We have also mentioned that this sentence is wrongly predicted to yield a garden path effect under the OLLC.

(183)

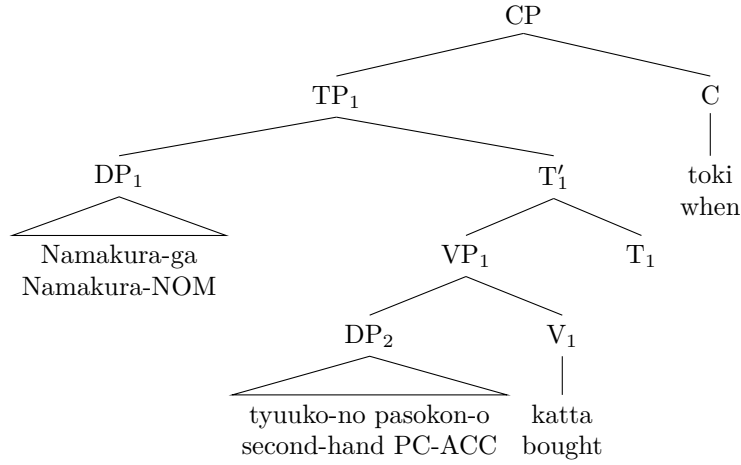

'When Nakamura bought a second-hand PC'

At this point, the parser encounters *repaired (for-me)*. Since this verb obligatorily takes an external argument, Licensed Lexical Projection requires that the the parser will project a syntactic position for this argument:

(184)

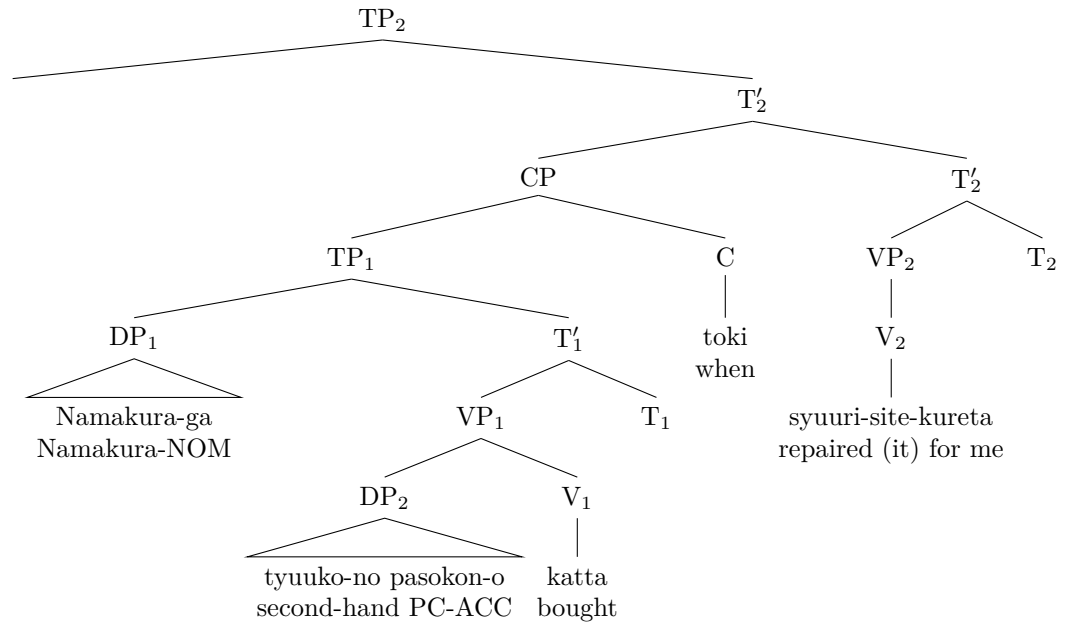

The created position in [Spec TP₂] needs to be filled. As mentioned in section 4.2.4, in Japanese, *kureru* is only used when the receiver is the speaker (or in the speaker's group). So, when the parser encounters *site-kureta* ('did-for my

benefit'), it "becomes apparent that Nakamura is the subject of the matrix verb and the subject of the embedded verb must be the speaker" (Mazuka & Itoh (1995)). Therefore, *Nakamura* is relocated in order to fill the empty position in [Spec TP₂].

(185)

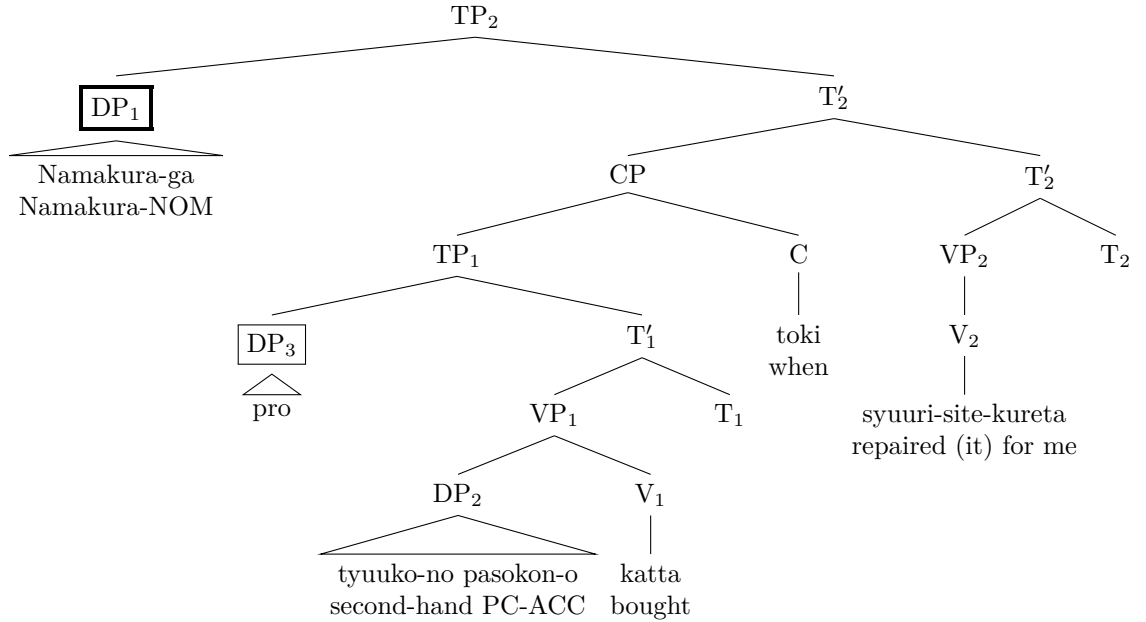

'Nakamura_i, when (I_j) bought a second-hand PC, repaired (it) for me_j.'

Nakamura has been relocated from the subject position of the adjunct (marked with a frame), where it is positioned in (183) and (184), to the subject position of the matrix clause (here marked with a bold frame). As noted in section 4.2.4, this reanalysis violates Structural Determinism, since it falsifies primary relations that were evident in (183), specifically $\text{dom}(\text{TP}_1, \text{DP}_1)$. However, deletion of the relation $\text{dom}(\text{TP}_1, \text{DP}_1)$ is permitted and required by Unconscious Deletion. In this case, β is DP_1 . Since the position of DP_1 after reanalysis *c*-commands its position prior to reanalysis, the relation $\text{dom}(\text{TP}_1, \text{DP}_1)$ is deleted. Therefore, it is no longer a relation in the tree-description, and the sentence is correctly predicted to be parsed with no processing breakdown in accordance with the Condition on Description Validity.⁵³

⁵³Descriptively comparing the structure in (183) and the structure in (185) reveals that other relations that held prior to reanalysis no longer hold after reanalysis. For example, consider the node D_1 dominated by DP_1 (and not explicitly shown). This node was also dominated by TP_1 prior to reanalysis, yet its new position does not *c*-command its original position. Thus, one might infer that the relation $\text{dom}(\text{TP}_1, D_1)$ has been falsified. Yet, according to Element Attachment defined in (171), this relation is not part of the tree description, as TP_1 is not the mother node of D_1 at the state where D_1 has been attached. Consequently, no garden path effect will be yielded according to the Condition on Description Validity.

Note that in the process described above, *Nakamura* was relocated to a position that has existed in the syntactic tree, since the matrix verb *did-for my benefit* caused the parser to project it. This raises the following question:

- (186) Can the parser project a position that an element will be relocated to (given that this relocation is licensed by UD), before another element (such as a head) initiates this projection?

Given Strict Incrementality, the prediction will be that the parser is indeed able to project such positions. After all, there is no need for a licensing head to appear prior to projecting positions as in head-driven licensing parsers. We will explicitly provide an answer to this question shortly. Now, let us consider (52) above, repeated below as (187):

- (187) _{GP}Yoko-ga kodomo-o koosaten-de mikaketa takusii-ni noeta.
 Yoko-NOM child-ACC intersection-LOC saw taxi-DAT put-on
 'Yoko put the child on the taxi she saw at the intersection.'

This sentence was wrongly predicted to be easy to process under reanalysis by movement hypothesis, as described in section 4.3.3. Let us consider the processing of this sentence given our assumptions. The parser attaches *Yoko*, *child* and *intersection* to the tree, and when encountering *mikaketa*, it has constructed a complete clause:

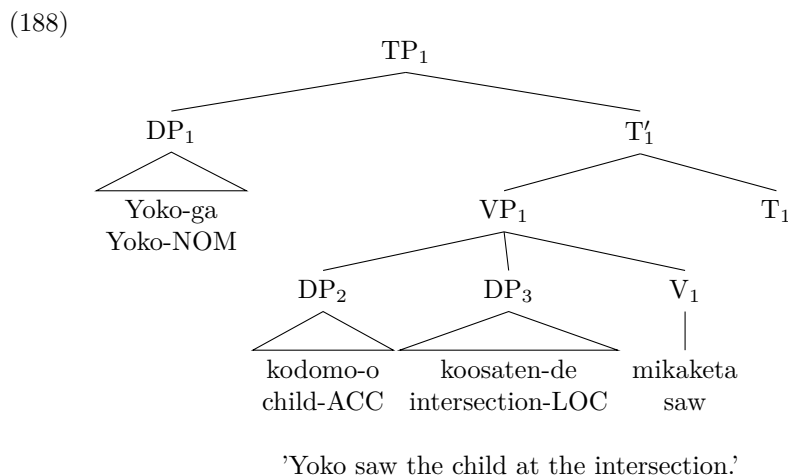

When the parser encounters *taxi*, it becomes clear that the clause constructed in (188) is not the matrix clause, but rather a relative clause modifying *taxi*. Note that since in Japanese the relative clause precedes its modified noun, this happens often during the processing of Japanese sentences. Inoue (1991) claims that there is a general preference, attested in Japanese speakers, to displace the minimal amount of material from a completed clause to a higher clause. In other words, the parser should attempt a “null-displacement” (not extracting anything

from within the relative clause), prior to trying a “single-displacement” (that is, extracting a single element out of the relative clause). Only when it is necessary, will the parser pursue a “double-displacement” - namely, extracting two elements out of the embedded clause.⁵⁴ Inoue (1991, p.138) calls this preference of the parser the “Minimal Expulsion Strategy”, meaning that the parser “expels the least number of arguments so that the currently being built complex NP is well-formed”. We can state this as follows:

(189) **Minimal Expulsion Strategy:** The parser attempts to displace the minimal amount of material from a completed clause to a higher clause.

(189) seems to stem from the general tendency to avoid reanalysis as much as possible, rather than being a principle on its own. Adopting (189), the parser is first liable to attempt null-displacement, yielding the meaning “the taxi where/when Yoko saw the child at the intersection”.⁵⁵ Since this meaning is implausible, the parser has to go on and displace a single argument. Since *Yoko* linearly precedes *child*, in order to displace only a single element from within the clause, it must be *Yoko* that is displaced - and a subject relative clause is created. The parser thus yields the following structure:

⁵⁴I adopt the terms “null-displacement”, “single-displacement” and “double-displacement” from Sturt & Crocker (1996).

⁵⁵In Japanese, this option could have been possible as there is no need to have a locative preposition in relative clauses.

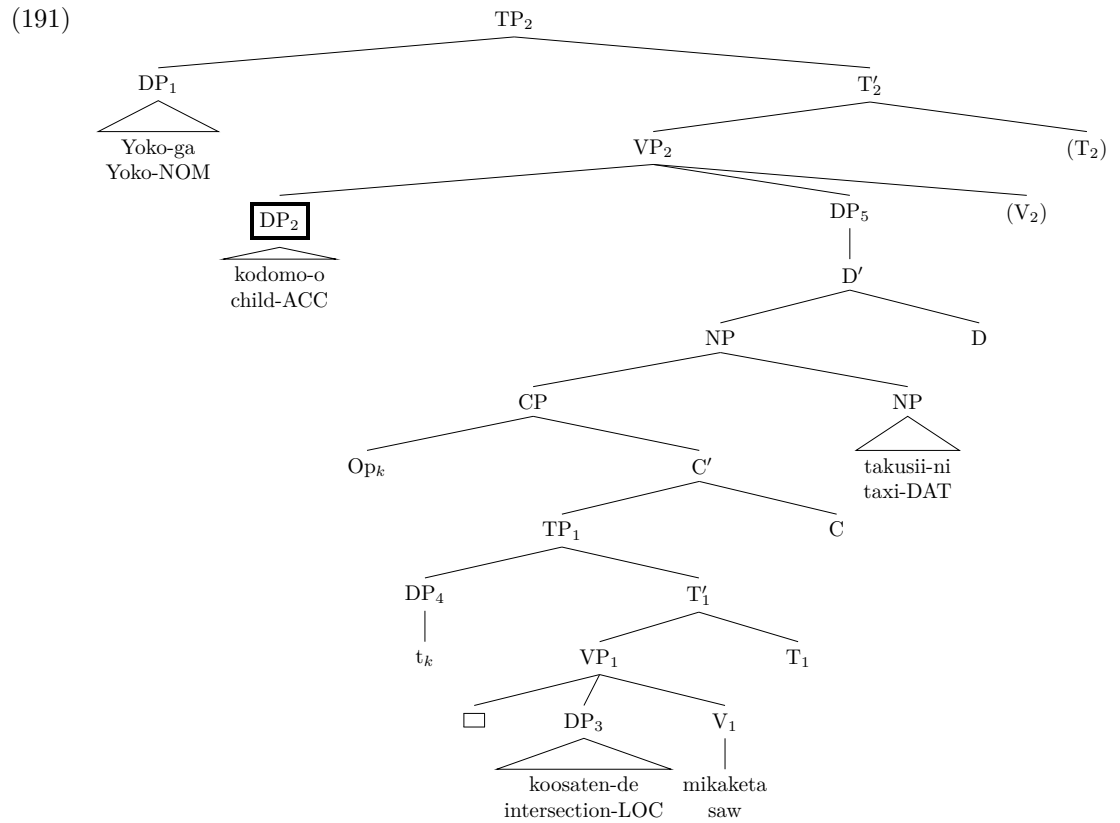

The above dislocation of *child* is also predicted to be easy to perform according to UD, as its new position as the complement of the matrix verb (marked by a bolded box) c-commands its original position as a complement of *saw* (marked by an empty box). Thus, the relation $\text{dom}(VP_1, DP_2)$ is deleted, and now the parser can posit the relative operator's trace at the object position:

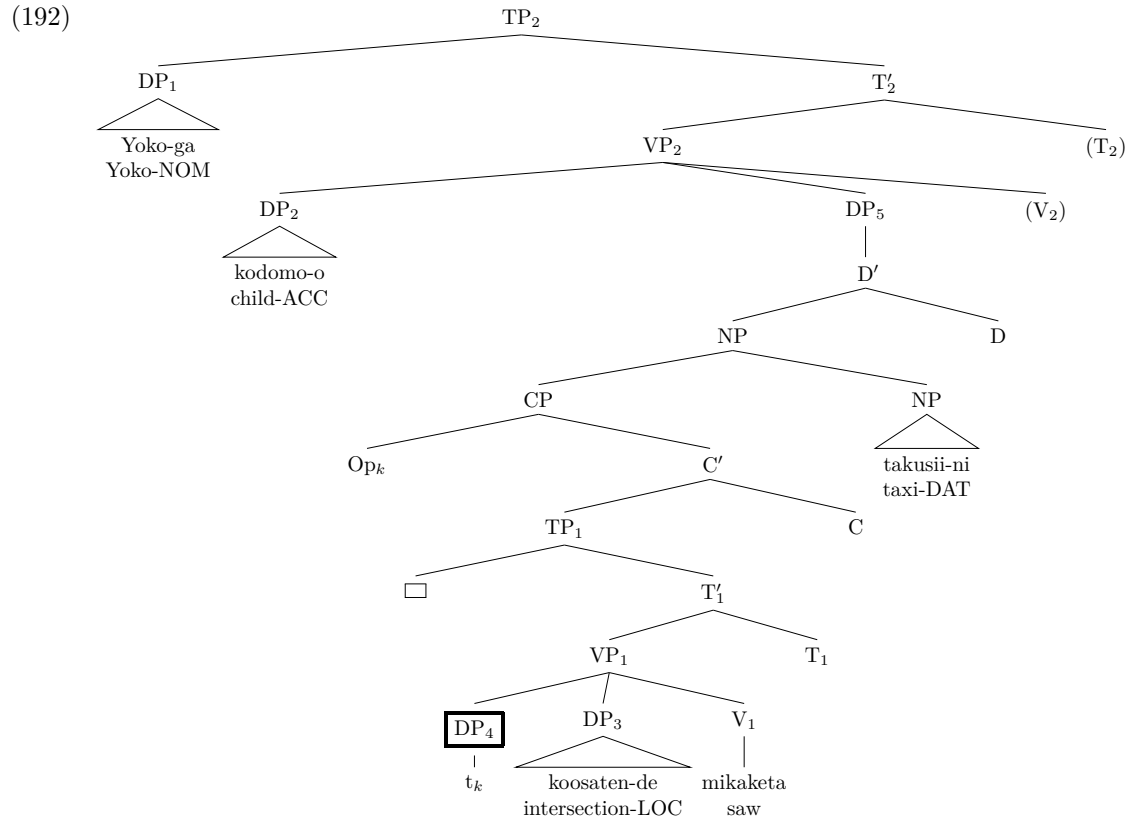

But the above relocation of the trace (DP_4) as the complement of *saw* is not possible under UD. That is, its new position as the complement of *saw* (marked by a bold box) does not c-command its source position (marked by an empty box). This relocation falsifies the relation $\text{prec}(DP_4, T'_1)$ that was evident in (191), and thus a garden path effect is sensed (as predicted by the Condition on Description Validity). In other words, under the current proposal, what causes the conscious processing breakdown is the parser's attempt to change its analysis of the relative clause from a subject relative to an object relative. We thus assume that if the parser can either hold its original analysis of the relative clause as a subject relative, or initially pursue an object relative, the sentence will be easy to process. That is, the following predictions regarding (187) stem from our assumptions:

- (193)
- a. Had the parser initially pursued an object relative analysis - no garden path effect would have been sensed.
 - b. Had the parser initially pursued a subject relative analysis, and this analysis had not been revisited - no garden path effect would have been sensed.

In order to examine these assumptions, let us consider several examples.

First, I will examine (193a), by considering (91), repeated below as (194a):

- (194) a. _{OK}∅ kodomo-o koosaten-de mikaketa takusii-ni noseta.
 ∅ child-ACC intersection-LOC saw taxi-DAT put-on
 '∅ put the child on the taxi (s)he saw at the intersection.'
- b. _{GP}Yoko-ga kodomo-o koosaten-de mikaketa takusii-ni
 Yoko-NOM child-ACC intersection-LOC saw taxi-DAT
 noseta.
 put-on
 'Yoko put the child on the taxi she saw at the intersection.'

(187) above is repeated as (194b), helping us to realize that the only difference between the two strings in (194) is the subject of the sentence - while in (194a) the subject is the phonetically unrealized element *pro*, in (194b) it is *Yoko*. Although this difference may seem insignificant, Mazuka & Itoh (1995) report that while (194b) yields a garden path effect, (194a) does not. Recall that in section 4.2.4 we have described the process of parsing (194a) and shown that it violates Structural Determinism, and thus a parser employing Structural Determinism wrongly predicts this sentence to yield a processing breakdown.

Let us now mark the critical difference between the processing of (194a) and (194b). When the parser encounters *child* in (194), the following structure can be created:

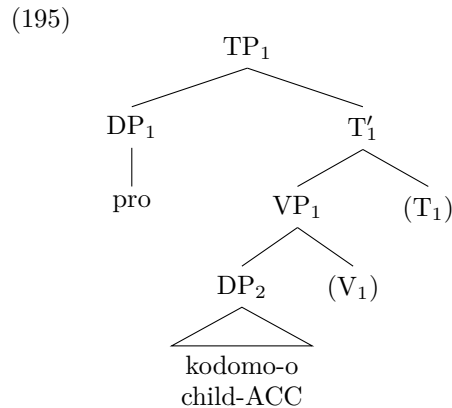

Next, the parser reaches *intersection* and attaches it to the syntactic tree. When the parser encounters the verb *saw*, the following clause is computed:

(196)

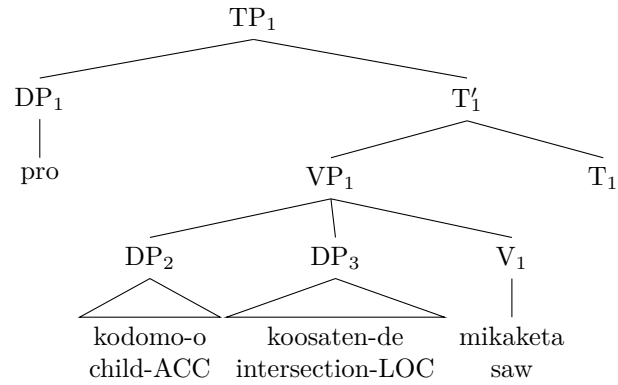

'∅ saw the child at the intersection.'

At this point, the parser encounters *taxi*, so the above clause turns out to be a relative clause. Crucially, in contrast to sentence (194b), *child* is not preceded by a phonetically realized element, and so the parser may only dislocate *child* in order to comply with Minimal Expulsion Strategy. That is, the following structure is constructed:

(197)

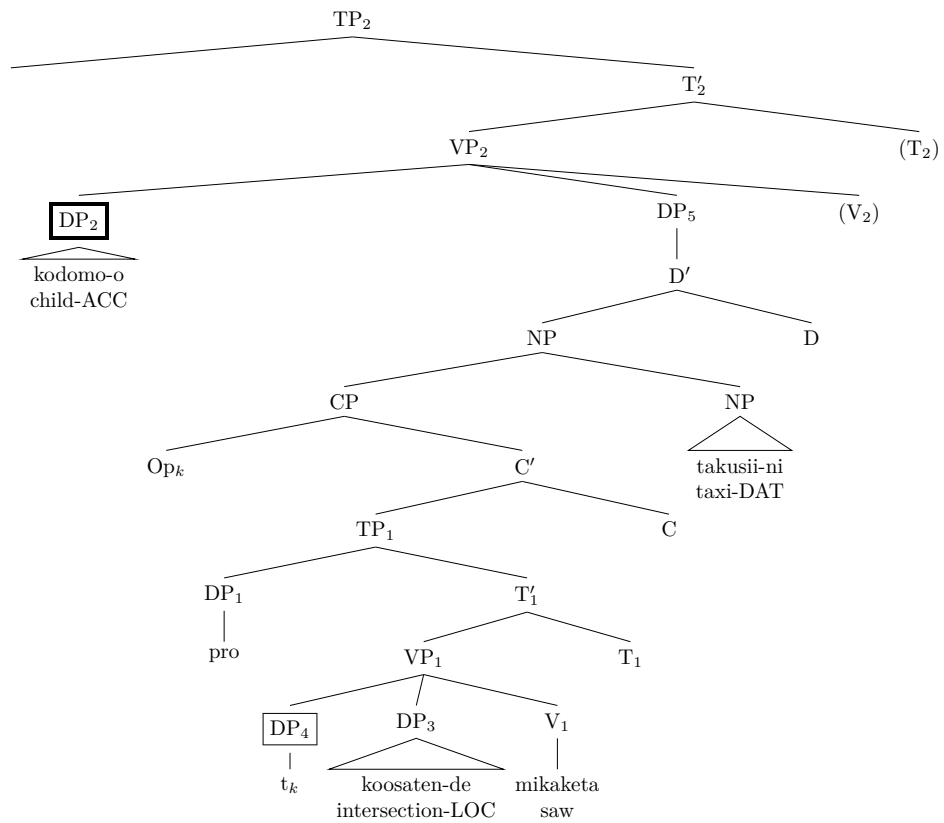

'the child... the taxi that \emptyset saw at the intersection.'

According to Unconscious Deletion, the dislocation of *child* is not predicted to yield a garden path effect, since its new position as the complement of the matrix verb (that is yet to appear), c-commands its previous position as a complement of *saw*. Therefore, the relation $\text{dom}(\text{VP}_1, \text{DP}_2)$ is deleted. Since the matrix subject position is empty, the parser now posits a *pro* in that position:

(198)

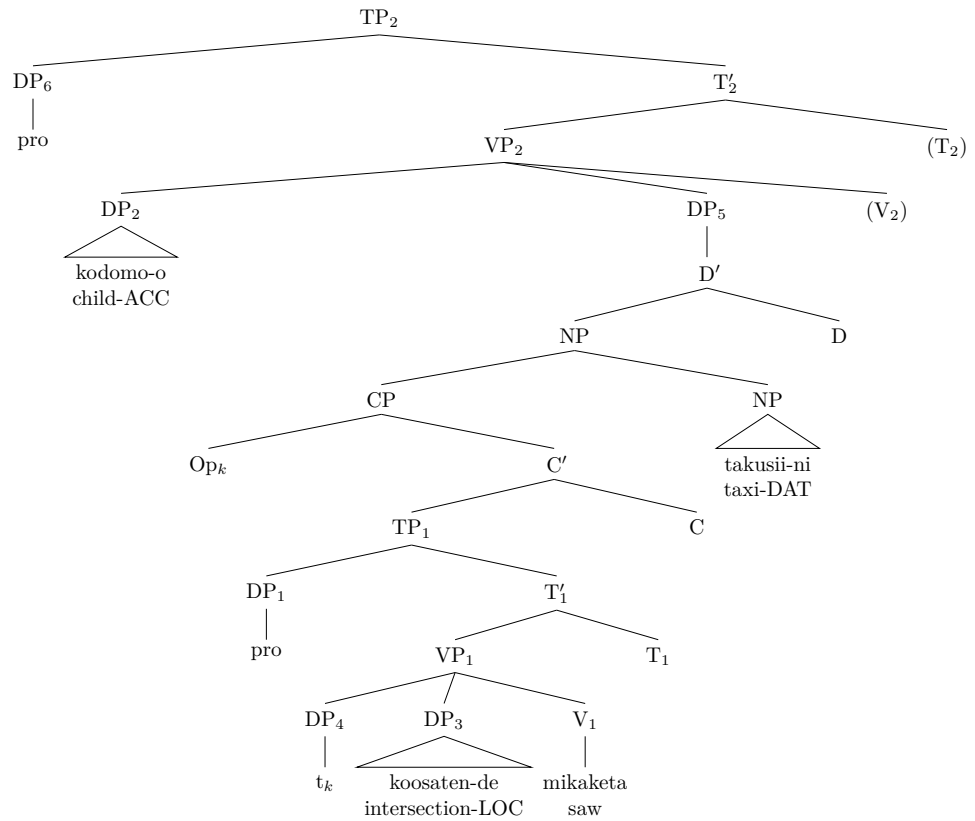

'∅... the child... the taxi that (s)he saw at the intersection.'

Finally, the parser reaches the matrix verb *put-on*, and the structure for the entire sentence can be computed by attaching this verb:

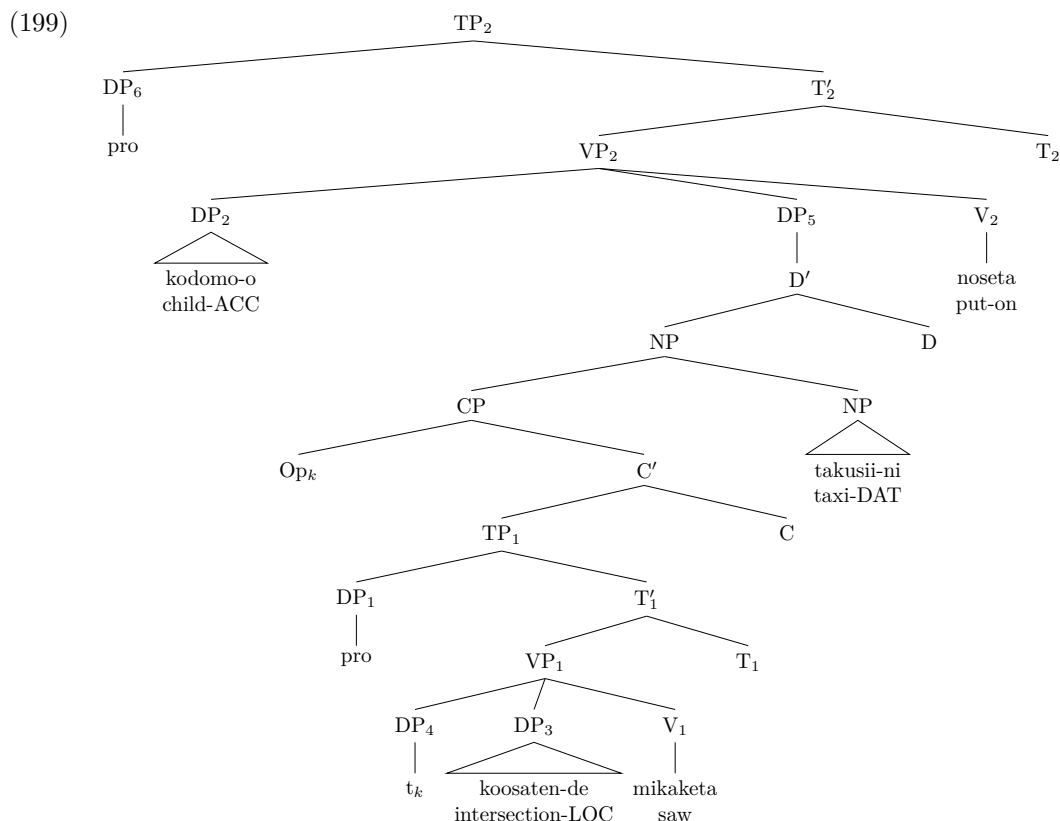

'∅ put the child on the taxi (s)he saw at the intersection.'

The crucial difference between the processing of (194a) and (194b) is that while in (194b) the parser commits to a subject relative clause analysis and then attempts to revise it to an object relative clause, in (194a) the parser computes an object relative clause without having to create a subject relative. This difference stems from the appearance of a phonetically realized noun in (194b), *Yoko*, that temporarily “blocks” the extraction of *child* out of the relative clause. Thus, the prediction stated in (193a) is verified.

Assuming the above process, we have also provided an answer for the question posited in (186), and repeated below:

- (200) Can the parser project a position that an element will be relocated to (given that this relocation is licensed by UD), before another element (such as a head) initiates this projection?

During processing of (194a), the parser has projected the position of a complement to the matrix verb, and relocated *child* to that position - in (197). Importantly, the parser has projected this position prior to the appearance of the matrix verb (*put-on*). We can thus conclude a positive answer to the above question, as predicted by Strict Incrementality:

- (201) **Observation:** The parser can project a position that an element will be relocated to (given that this relocation is licensed by UD), before another element (such as a head) initiates this projection.

Our assumptions also account for the fact that the following sentence is easy to process:

- (202) _{OK}Yoko-ga kodomo-o koosaten-de mikaketa onnanoko-ni
 Yoko-NOM child-ACC intersection-LOC saw girl-DAT
 koe-o-kaketa.
 called
 'Yoko called the girl who saw the child at the intersection.'
 -Mazuka & Itoh (1995) (8b)

As the string is identical to sentence (187) above up to and including the verb *saw*, we can assume that the parsing process is the same, and the following structure is computed (as in (188) above):

- (203)
-
- ```

graph TD
 TP1[TP1] --- DP1[DP1]
 TP1 --- T1_prime[T'1]
 DP1 --- Yoko_ga[Yoko-ga]
 Yoko_ga --- Yoko_NOM[Yoko-NOM]
 T1_prime --- VP1[VP1]
 T1_prime --- T1[T1]
 VP1 --- DP2[DP2]
 VP1 --- DP3[DP3]
 VP1 --- V1[V1]
 DP2 --- kodomo_o[kodomo-o]
 kodomo_o --- child_ACC[child-ACC]
 DP3 --- koosaten_de[koosaten-de]
 koosaten_de --- intersection_LOC[intersection-LOC]
 V1 --- mikaketa[mikaketa]
 mikaketa --- saw[saw]

```
- 'Yoko saw the child at the intersection.'

At this point, the parser encounters *girl*, and the clause described in (203) turns out to be a relative clause. Since the null-displacement option yields an implausible meaning ('the girl where/when Yoko saw the child at the intersection'), the parser attempts a single-displacement, extracting *Yoko* from within the embedded clause:



(204)

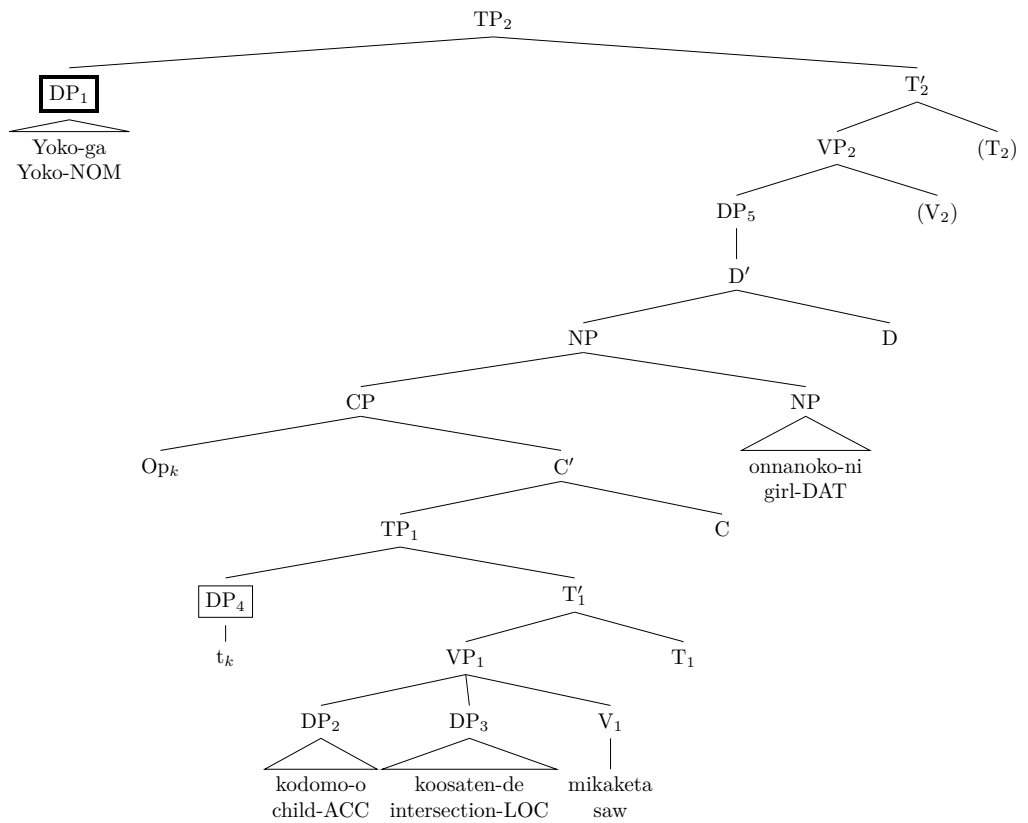

'Yoko... the girl who saw the child at the intersection.'

Since *Yoko*'s new position as the matrix subject (marked by a bold box) c-commands its original position as the subject of the relative clause (marked by a box), the relation  $\text{dom}(\text{TP}_1, \text{DP}_1)$  is deleted according to Unconscious Deletion. Now, the matrix verb *called* is reached, and the final structure can be computed:

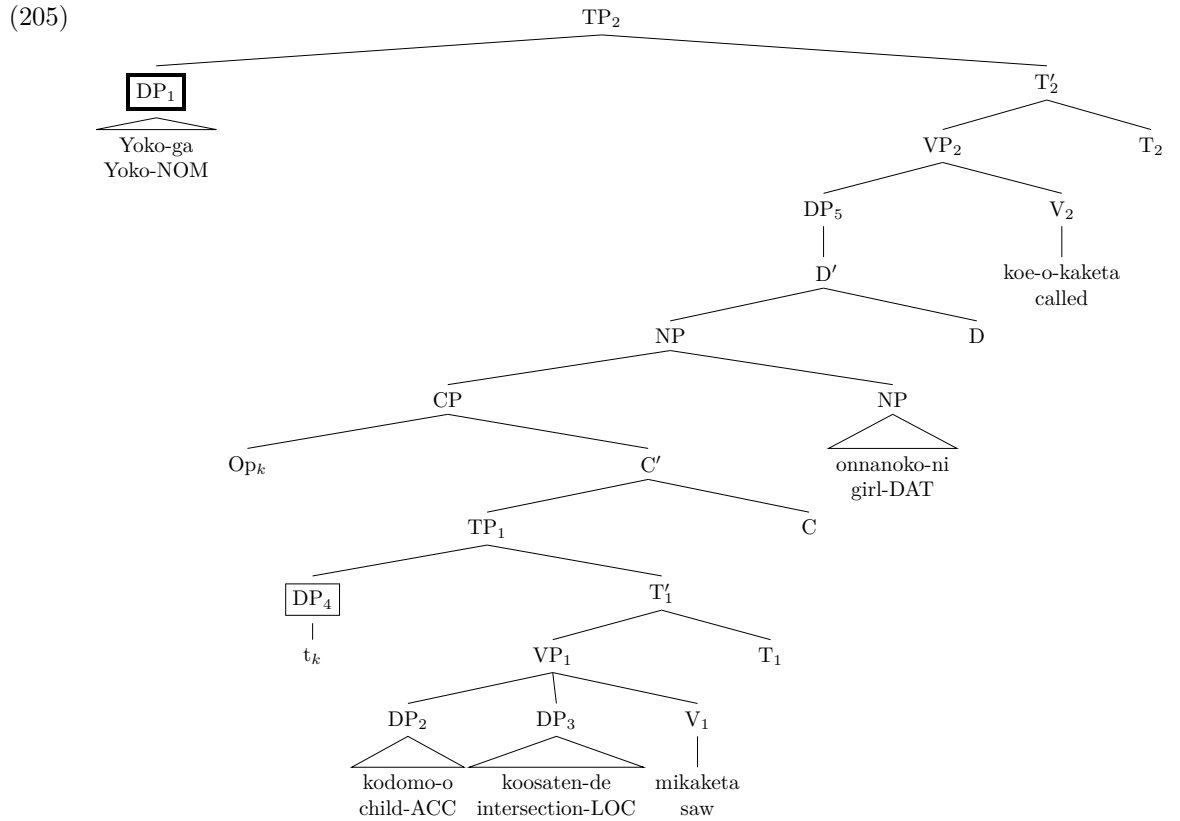

'Yoko called the girl who saw the child at the intersection.'

Note that the easiness of processing (202) can also be accounted for under Structural Determinism<sup>56</sup> and under reanalysis by movement. However, as shown in sections 4.2.4 and 4.3.3, these theories do not account for the entire data.<sup>57</sup>

<sup>56</sup>In order to account for the easiness of parsing (202) under Structural Determinism, it should be assumed that in (204) above, *Yoko* hasn't been dislocated from within the embedded clause, but rather the entire constituent  $T'_1$  has been *lowered*. A similar example, sentence (71a), has been discussed in detail under this view in section 4.2.3.

<sup>57</sup>In order to account for some Japanese examples, Sturt & Crocker (1996) allow for "lowering" X' nodes (such as V') as well as head nodes. In the current proposal, these cases are accounted for either by deleting relations (according to Unconscious Deletion), or by adding relations on top of maximal projections. That is, we can limit addition of relations as follows:

- (1) A relation  $R(\alpha, \beta)$  may be added to the structure iff  $\beta$  is a maximal projection or  $\beta$  has not been added to the structure.

In other words, adding relations between two existing nodes where  $\beta$  is not a maximal projection is not allowed. This constraint limits the search space for possible operations to perform.

We shall now consider (206a), which seems very similar to (187) (repeated as (206b)), but does not result in a garden path effect.

- (206) a. <sub>OK</sub> kodomo-o Yoko-ga koosaten-de mikaketa takusii-ni  
 child-ACC Yoko-NOM intersection-LOC saw taxi-DAT  
 noseta.  
 put-on  
 'Yoko put the child on the taxi she saw at the intersection.'  
 -Mazuka & Itoh (1995), (46c)
- b. <sub>GP</sub> Yoko-ga kodomo-o koosaten-de mikaketa takusii-ni  
 Yoko-NOM child-ACC intersection-LOC saw taxi-DAT  
 noseta.  
 put-on  
 'Yoko put the child on the taxi she saw at the intersection.'

The only difference between the two strings in (206) is the position of the *child* - while in (206b) it is in its canonical position, in (206a) it is scrambled to sentence-initial position. According to Mazuka & Itoh (1995), (206a) does not yield a garden path effect.

When the parser processes the string in (206a) up to and including the verb *saw*, it builds the following clause:

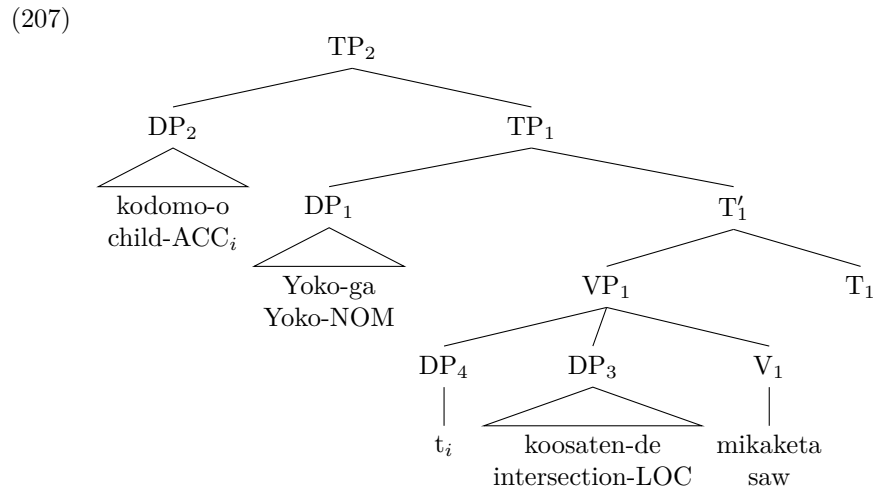

'Yoko saw the child at the intersection.'

Then, the parser encounters *taxi*. Since a null-displacement yields an impossible interpretation ('the taxi where/when Yoko saw the child at the intersection'), the parser attempts a single-displacement. Since *child* precedes *Yoko*, a single-displacement will obligatorily involve displacing *child* (together with its trace), rather than *Yoko*, from within the embedded clause. This results in the following structure:

(208)

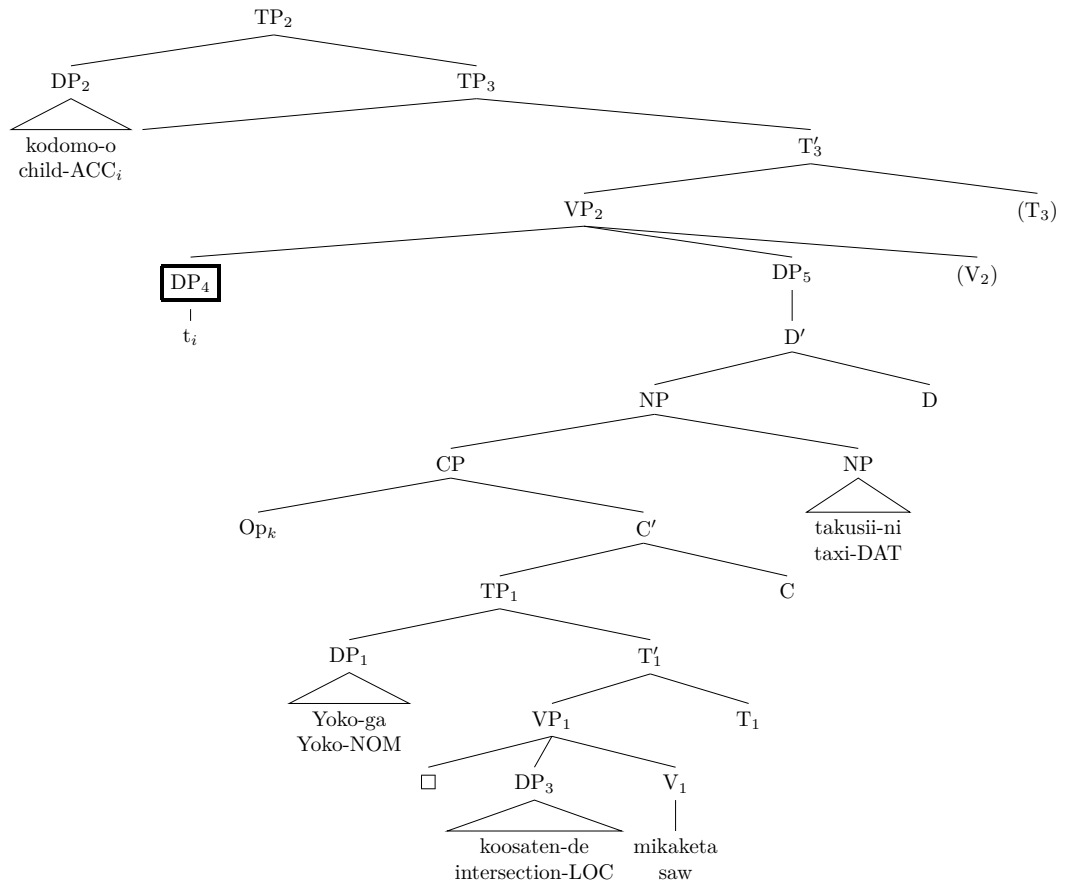

'The child... The taxi that Yoko saw at the intersection.'

The relocation above is not assumed to result in a garden path effect under Unconscious Deletion. The position of DP<sub>4</sub> after reanalysis, as a complement of the matrix verb (marked with a bold box) c-commands its original position as the complement of the embedded verb (marked with a box). In addition, the new position of DP<sub>2</sub> c-commands its original position, as it c-commands the entire sentence.

At this point, the trace of the relative operator is posited as a complement to the verb *saw*, and the matrix subject's position remains unrealized. There are two possible ways to fill this empty position. The first way is to posit a *pro* there, and eventually (upon the appearance of the matrix verb) yield the meaning of 'he/she put the child on the taxi that Yoko saw at the intersection'. The other possibility is to dislocate Yoko from within the matrix clause to the position of the matrix subject, and posit a *pro* in the position of the embedded subject, yielding the meaning of 'Yoko put the child on the taxi that she saw at the intersection'. That is, at this point, these are two possible interpretations:

- (209) a. kodomo-o  $\emptyset_i$  [Yoko-ga<sub>j</sub>  $\emptyset_k$  koosaten-de mikaketa  
 child-ACC  $\emptyset_i$  Yoko-NOM<sub>j</sub>  $\emptyset_k$  intersection-LOC saw  
 takusii-ni<sub>k</sub>] noseta.  
 taxi-DAT<sub>k</sub> put-on  
 '∅ put the child on the taxi that Yoko saw at the intersection.'
- b. kodomo-o Yoko-ga<sub>j</sub> [ $\emptyset_j$   $\emptyset_k$  koosaten-de mikaketa  
 child-ACC Yoko-NOM<sub>j</sub>  $\emptyset_j$   $\emptyset_k$  intersection-LOC saw  
 takusii-ni<sub>k</sub>] noseta.  
 taxi-DAT<sub>k</sub> put-on  
 'Yoko put the child on the taxi that she saw at the intersection.'

In general, speakers prefer not to have a phonetically null argument (*pro*), without an immediately identified antecedent.<sup>58</sup> Therefore, although (209a) is a possible interpretation of the sentence in (206a), it is not the preferred one according to Mazuka & Itoh (1995). The parser prefers to dislocate *Yoko*, and yield the meaning in (209b), by computing the following structure:

---

<sup>58</sup>This seems to be a general cognitive preference. That is, when the sentence stands in isolation, it is more cognitively felicitous not to start with a pronoun. This preference seems to invoke a dislocation that is not necessary (that is, the built structure can be grammatical without it). Inoue (1991) explicitly stated this preference as Least Gap Strategy:

- (1) **Least Gap Strategy:** The parser assumes the least number of phonetically null argument positions (gaps) whose antecedent cannot be immediately identified either in the sentence or from the discourse.  
 -Inoue (1991), p. 144

Inoue (1991) provides other examples where Least Gap Strategy seems to play a role in processing Japanese sentences. He observes that in some cases, the parser changes the computed analysis in order to minimize the number of phonetically null arguments whose antecedents cannot be immediately identified “even though this entails revising the earlier analysis”, and notes that it “may be regarded as another case of revision not as last resort”.

(210)

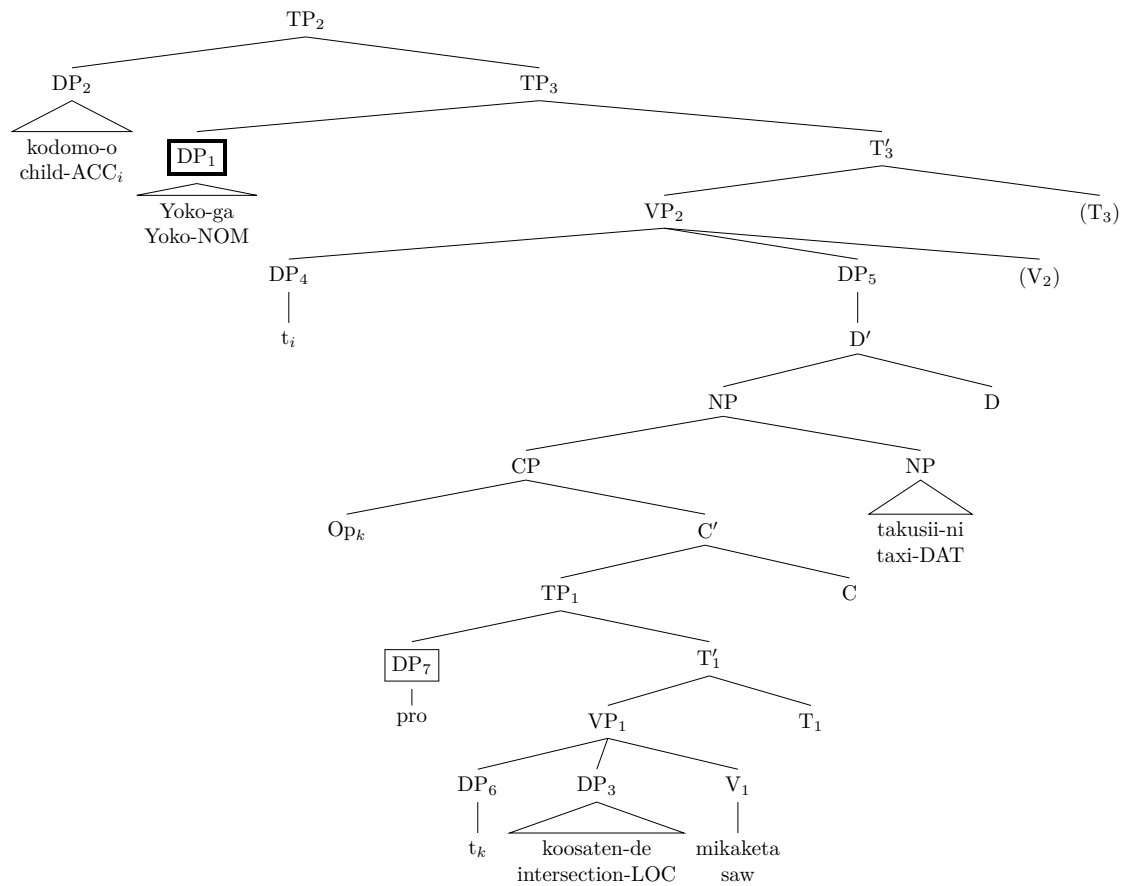

'The child... Yoko... The taxi that she saw at the intersection.'

According to Unconscious Deletion and the Condition on Description Validity, the above relocation of *Yoko* is not predicted to yield a garden path effect, since the new position of *Yoko* as the subject of the matrix clause (marked by a bold box) *c*-commands its original position as the subject of the embedded clause (marked by a box). Lastly, the matrix verb appears, and the final structure is constructed:

(211)

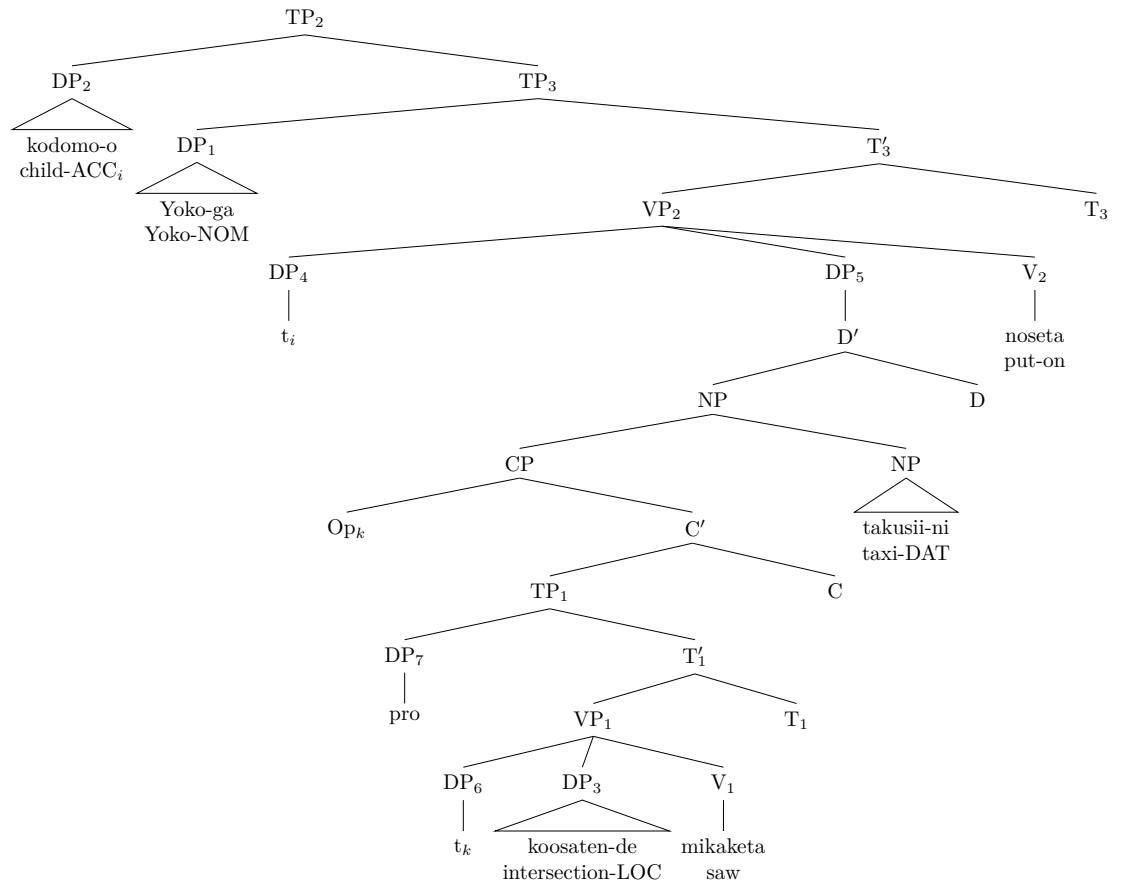

'Yoko put the child on the taxi that she saw at the intersection.'

Note that, during the processing of (206a) as described above, the parser has initially pursued an object relative analysis of the relative clause modifying *taxi*, an analysis which remained intact until the end of the sentence. This differs from (206b), where the parser is assumed to first attempt a subject relative analysis (by performing single-displacement), which is later proven to be incompatible and requires a revision into an object relative clause, but this revision fails as described above. That way, we can explain the fact that (206b) yields a garden path effect, while (206a) does not. Again, the prediction stated in (193a) is verified.

We shall now examine the prediction stated in (193b) - namely, that in case the parser had initially pursued a subject relative analysis, and this analysis had not been revisited - no garden path effect would have been sensed.

Mulders (2002) provides example (212a), which does not result in a processing breakdown:

- (212) a. <sub>OK</sub>Yoko-ga kodomo-o koosaten-de mikaketa uma-ni  
 Yoko-NOM child-ACC intersection-LOC saw horse-DAT  
 noseta.  
 put-on  
 'Yoko put him/her on the horse that saw the child at the intersection.'
- b. <sub>GP</sub>Yoko-ga kodomo-o koosaten-de mikaketa takusii-ni  
 Yoko-NOM child-ACC intersection-LOC saw taxi-DAT  
 noseta.  
 put-on  
 'Yoko put the child on the taxi she saw at the intersection.'

(187) above is repeated as (212b), allowing us to see that the only difference between the two strings in (212) is the dative-marked object - *horse* or *taxi*.

Let us consider the processing of (212a). As the string is identical to (212b) up to and including the verb *saw*, the processing is assumed to be the same, and the following structure is yielded (as in (188) above):

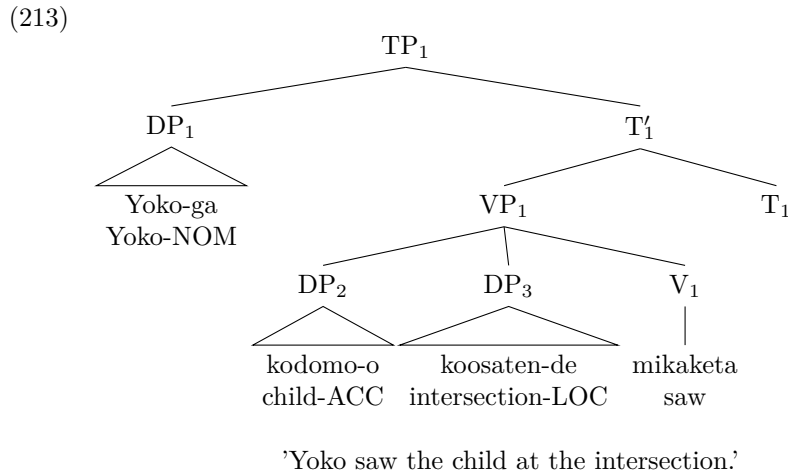

At this point, the parser encounters *horse*. Thus, the clause described in (213) turns out to be a relative clause modifying the *horse*, rather than a matrix clause. The parser is assumed to consider a null-displacement structure, with the meaning “the horse where/when Yoko saw the child”. As this meaning is implausible, the parser then performs a single-displacement, extracting *Yoko* outside the relative clause:



(214)

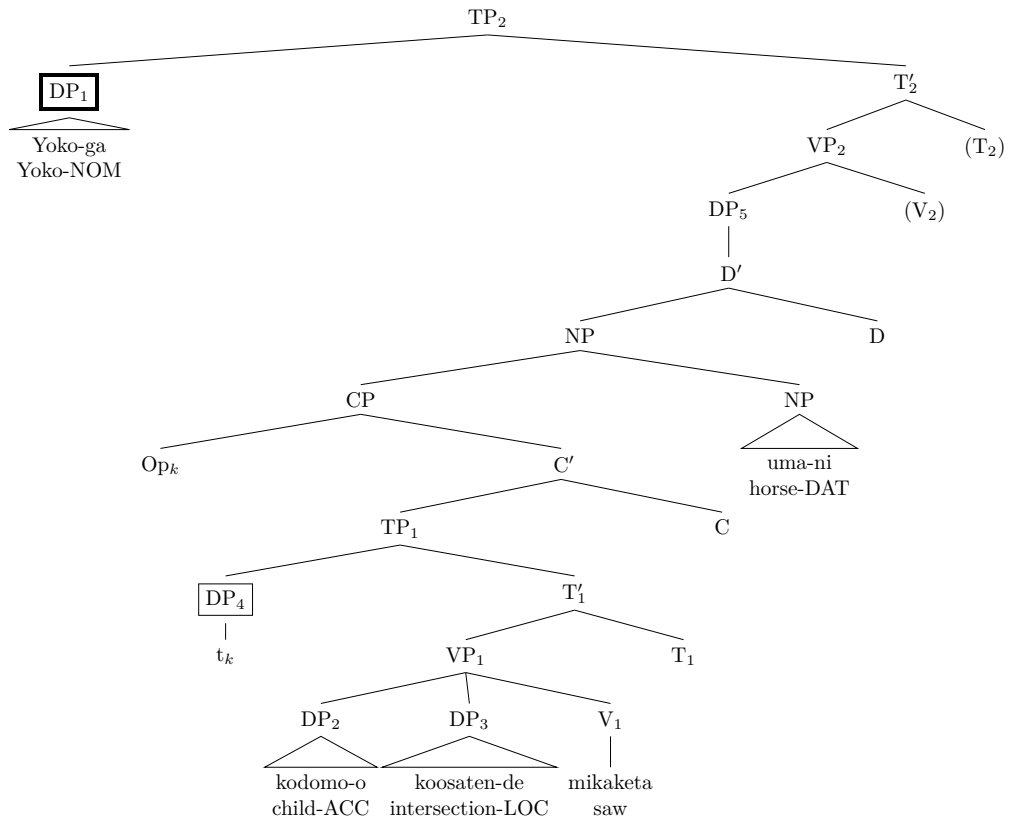

'Yoko... the horse that saw the child at the intersection.'

Since *Yoko*'s new position as the matrix subject (marked by a bold box) c-commands its original position as the subject of the relative clause (marked by a box), the relation  $\text{dom}(\text{TP}_1, \text{DP}_1)$  is deleted according to Unconscious Deletion. At this point, the yielded meaning ('the horse that saw the child at the intersection') is plausible, as *horse* can be the external argument for the verb *saw*. As a result, it is unnecessary to dislocate *child* from the relative clause, and the parser will not attempt to do so, as it follows the Minimal Expulsion Strategy. At this point, the parser encounters the matrix verb *put-on*, which takes two complements. The following structure is thus constructed:

(215)

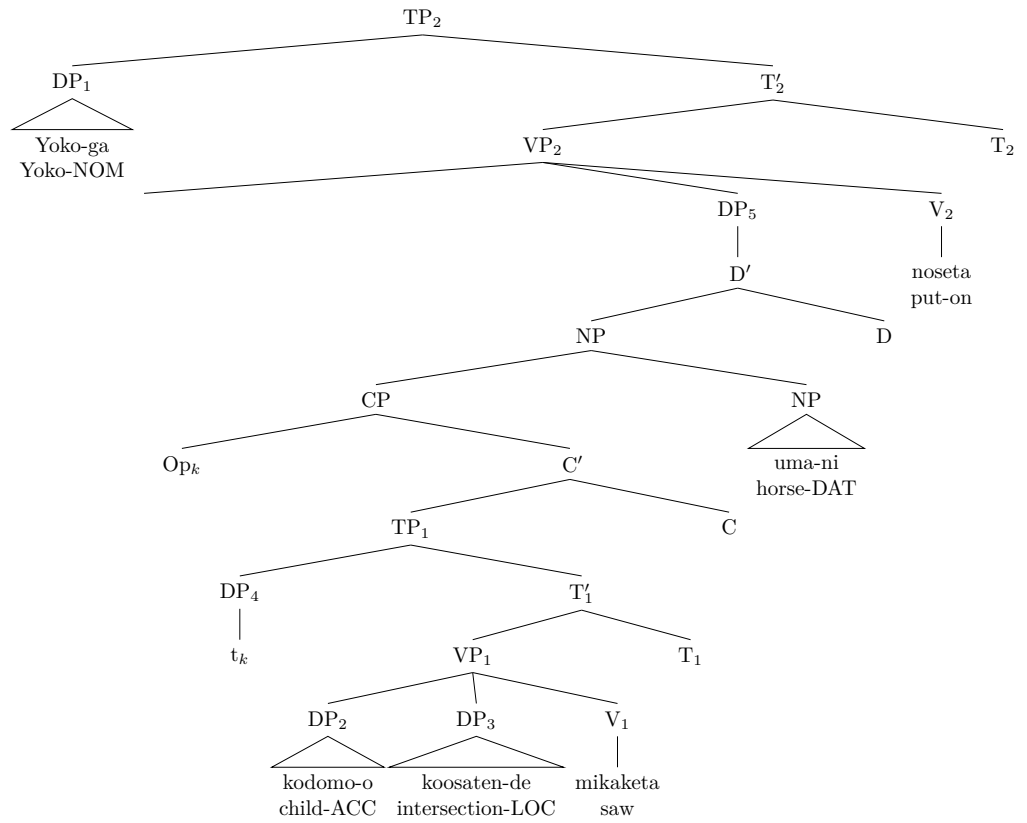

Since *put-on* is ditransitive, and the parser has projected a position for its complement, a *pro* is inserted in order to fill the empty position. The final structure is obtained:

(216)

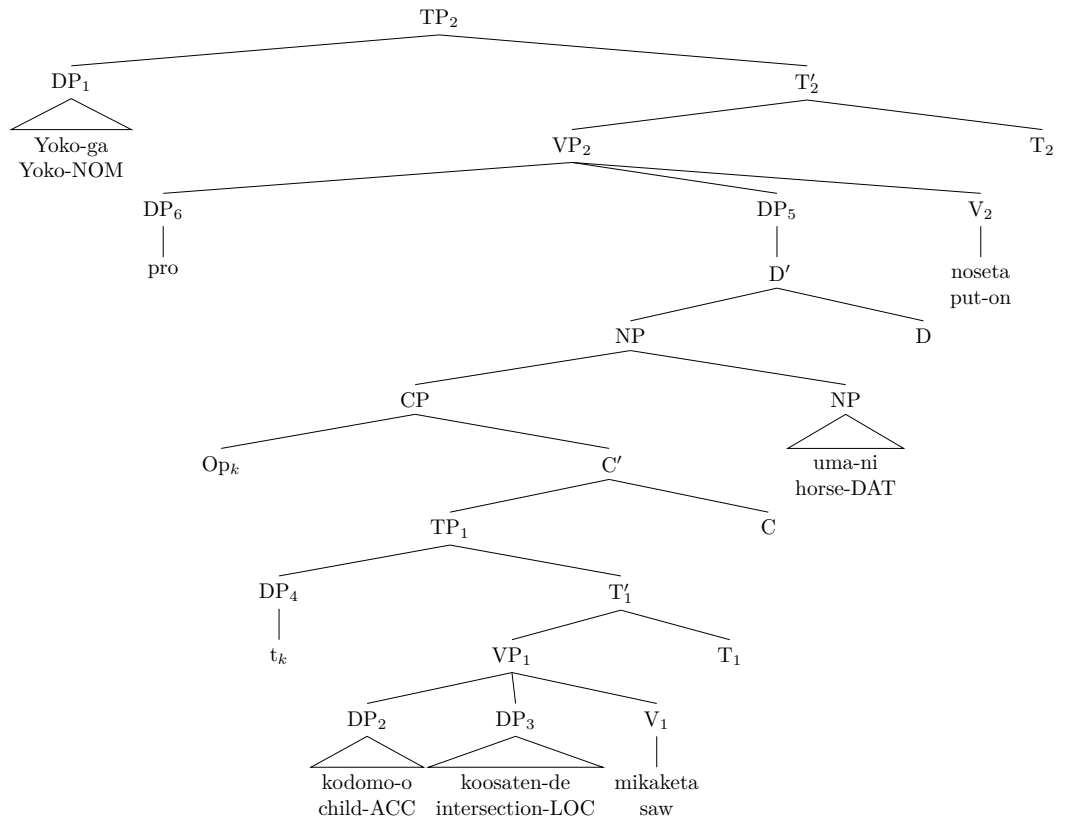

'Yoko put him/her on the horse that saw the child at the intersection.'

The fact that (212a) does not result in a garden path effect is accounted for, since the only relations that have been falsified during parsing were deleted due to Unconscious Deletion.

Sentence (212a) shows that had the parser not had to revise its initial subject relative clause into an object relative clause, a processing breakdown would not have occurred.

At this point we should consider another option, available as the parser reaches the structure described in (215). The parser may indeed insert a *pro* as in (216), described below as (217a), but the parser may also choose to extract *child* to the matrix clause, and insert a *pro* in the subordinate clause, as described in (217b):

- (217) a. Yoko-ga  $\emptyset_i$  [ $\emptyset_k$  kodomo-o koosaten-de mikaketa  
 Yoko-NOM  $\emptyset_i$  [*emptyset*<sub>k</sub> child-ACC intersection-LOC saw  
 uma-ni<sub>k</sub>] noseta.  
 horse-DAT<sub>k</sub>] put-on  
 'Yoko put  $\emptyset$  on the horse that saw the child at the intersection.'

- b. Yoko-ga<sub>j</sub> kodomo-o [ $\emptyset_j$   $\emptyset_k$  koosaten-de  
 Yoko-NOM<sub>j</sub> child-ACC [*emptyset<sub>j</sub>* *emptyset<sub>k</sub>* intersection-LOC  
 mikaketa uma-ni<sub>k</sub>] noseta.  
 saw horse-DAT<sub>k</sub>] put-on  
 'Yoko<sub>j</sub> put the child on the horse that she<sub>j</sub> saw at the intersection.'

Computing (217b) involves revising the relative clause from its subject relative analysis, to an object relative analysis - which will result in a processing breakdown according to our assumptions. Indeed, Mulders (2002) reports that Japanese speakers understand (212a) as in (217a).<sup>59</sup> This fact further supports our hypothesis, according to which the reason for the garden path effect in (212b) is the revision of a constructed subject relative clause into an object relative clause, which involves falsifying relations that are not deleted in accordance with Unconscious Deletion, and thus the Condition on Description Validity predicts a processing breakdown.

## 6.4 Predictions of Unconscious Deletion regarding other garden path sentences

In previous sections, we have reviewed the current proposal. Given the assumptions summarized in section 6.2 regarding the structure building by the parser, as well as the claims in section 6.3 regarding reanalysis, we can examine the predictions that the suggested hypothesis yields regarding different garden path sentences.

### 6.4.1 Reanalysis triggered by a theta-assigner

In section 6.3, we have thoroughly discussed Japanese sentences that include a relative clause, and where the need for reanalysis is evident when the parser encounters the modified noun phrase. For example, we discussed the processing of sentence (52), repeated below as (218):

- (218) <sub>GP</sub>Yoko-ga kodomo-o koosaten-de mikaketa takusii-ni noseta.  
 Yoko-NOM child-ACC intersection-LOC saw taxi-DAT put-on  
 'Yoko put the child on the taxi she saw at the intersection.'

As explained in section 6.3, the reanalysis is triggered by a non theta-assigner (*taxi*). As explained in section 4.1.4, the fact that the reanalysis is triggered by a non theta-assigner allows the parser, under certain head-driven licensing parsers (such as the OLLC) to use a rebuffering mechanism. Therefore, Mazuka & Itoh (1995) make a distinction between Japanese sentences where the need of reanalysis becomes clear by the appearance of a theta-assigner, and those where it becomes clear when the parser encounters a non theta-assigner.

<sup>59</sup>Since (217a) includes an uncontrolled phonetically unrealized argument, (217b) is clearly preferred over (217a) according to Least Gap Strategy. Yet, according to the current proposal, (217b) will result in a garden path effect.

In this section, we shall validate the current proposal regarding Japanese sentences where reanalysis is invoked by a theta-assigner, such as the following sentence:

- (219) <sub>GP</sub>Huruhasi-ga Yumiko-o yobidasita kissaten-ni nagai koto  
 Huruhasi-NOM Yumiko-ACC summoned tearoom-LOC long time  
 mata-seta.  
 wait-made  
 'Huruhasi made Yumiko wait for a long time at the tea room to which  
 he summoned her.'  
 -Mazuka & Itoh (1995) (17c)

Let us consider the processing of the sentence above. By the time the parser reaches *summoned*, the following clause can be computed:

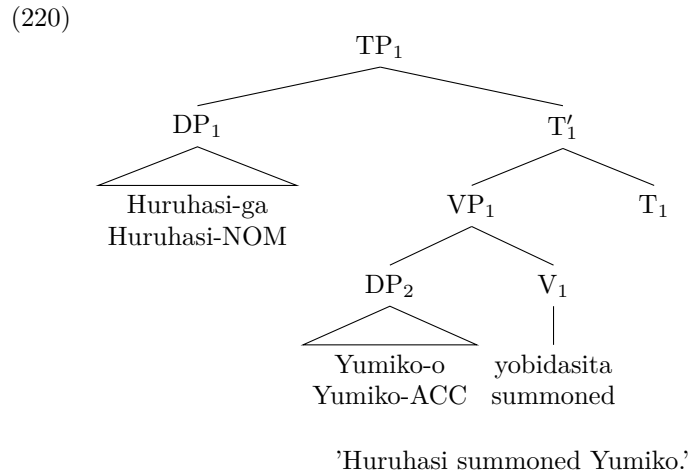

At this point, the parser reaches *tearoom*, and the above clause is attached as a relative clause modifying this NP<sup>60</sup> (complying with Minimal Expulsion Strategy - the parser pursues null-displacement when possible):

<sup>60</sup>Recall that there is no need to have a locative preposition in Japanese relative clauses.

(221)

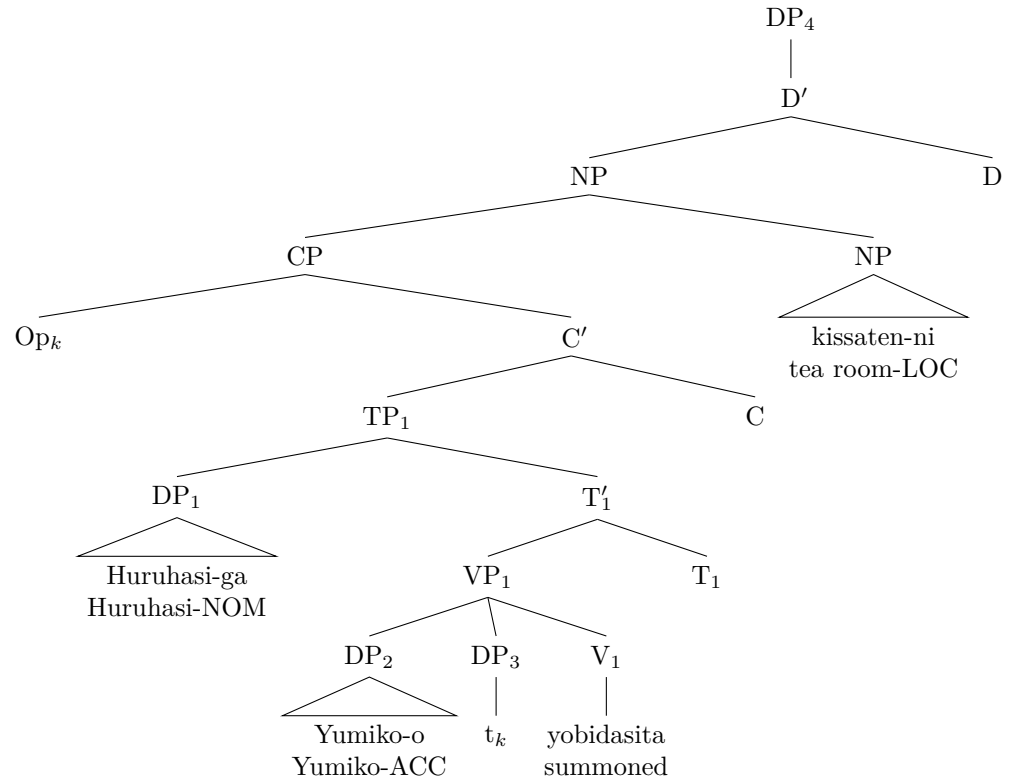

'The tea room where Huruhasi summoned Yumiko.'

When the parser reaches the matrix verb, *wait-made*, the above structure is falsified and a reanalysis is required. Since *wait-made* is a transitive verb, which obligatorily takes an external argument and an internal argument, the parser projects the following structure (I omit the adverb *long time* for simplicity):

(222)

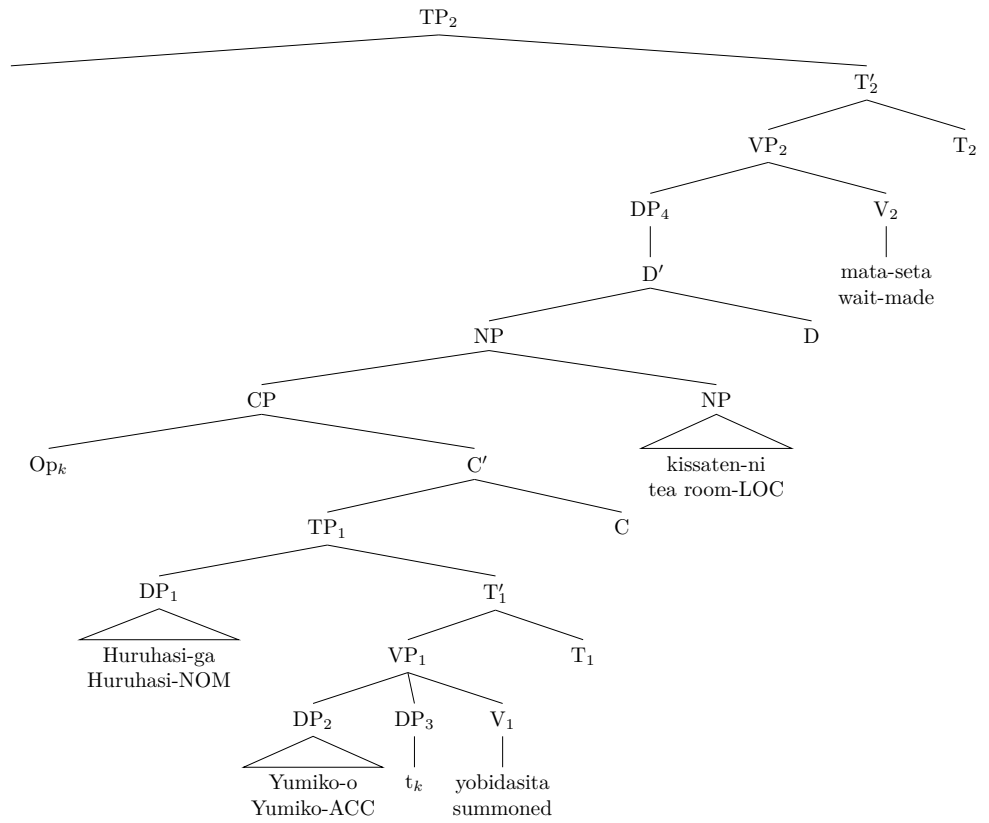

At this point, *Huruhasi* is relocated from the relative clause to the empty position at [Spec TP<sub>2</sub>]:

(223)

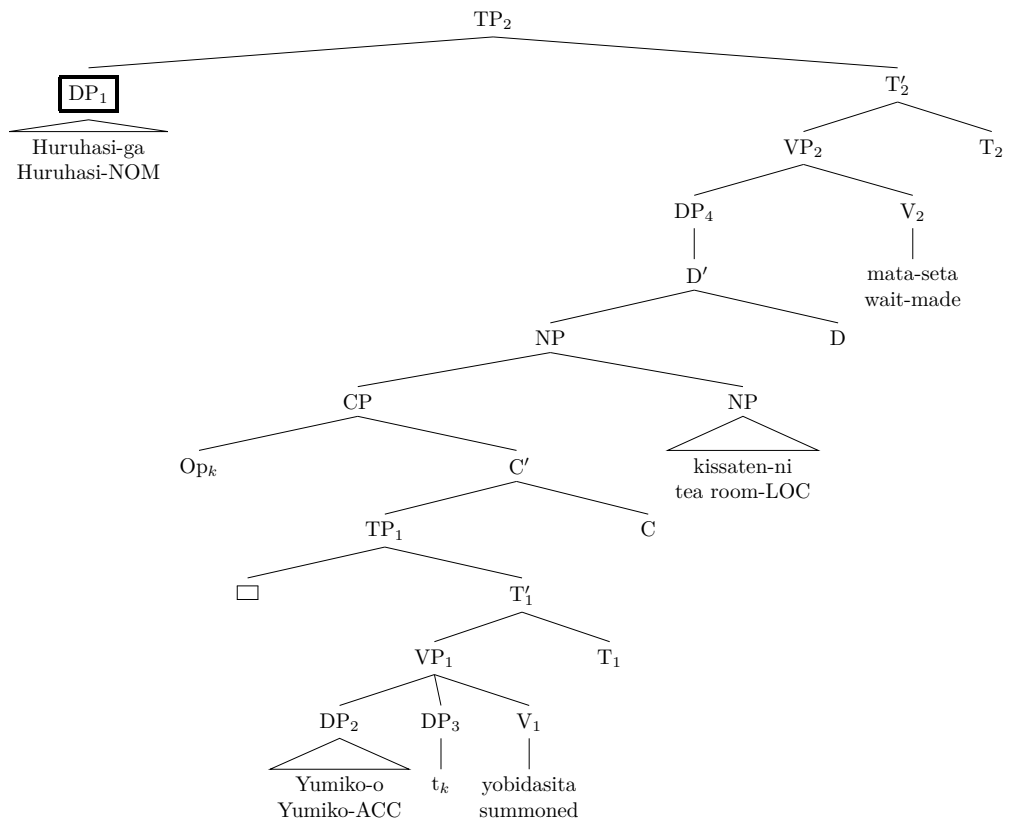

Since the position of  $DP_1$  after reanalysis (marked by a bold box) c-commands its original position as subject of the subordinate clause (marked by a box), the relation  $\text{dom}(TP_1, DP_1)$  is deleted according to UD, and this relocation should not result in a processing breakdown. In attempt to yield a grammatical structure, the parser then pursues the following structure, with a subject relative clause:



(224)

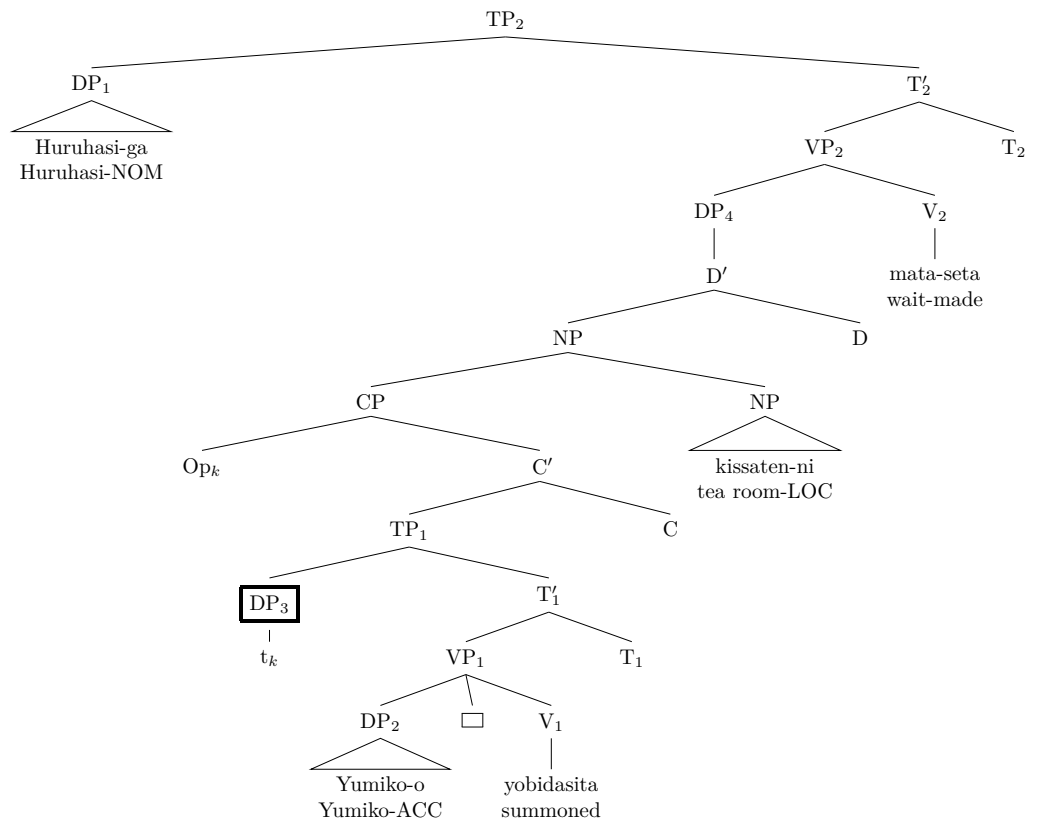

The above reanalysis is reached by relocating  $DP_3$  from its position as a complement of the verb *summoned* (marked by a box) to the subordinate subject position (marked by a bold box). This relocation is also permitted by UD, and is not assumed to yield a garden path effect. However, the structure described in (224) is semantically implausible (both since a *tea room* is not a plausible complement for *wait-made*, and because a *tea room* is not a plausible external argument for *summoned*). Therefore, the following reanalysis is necessary:

(225)

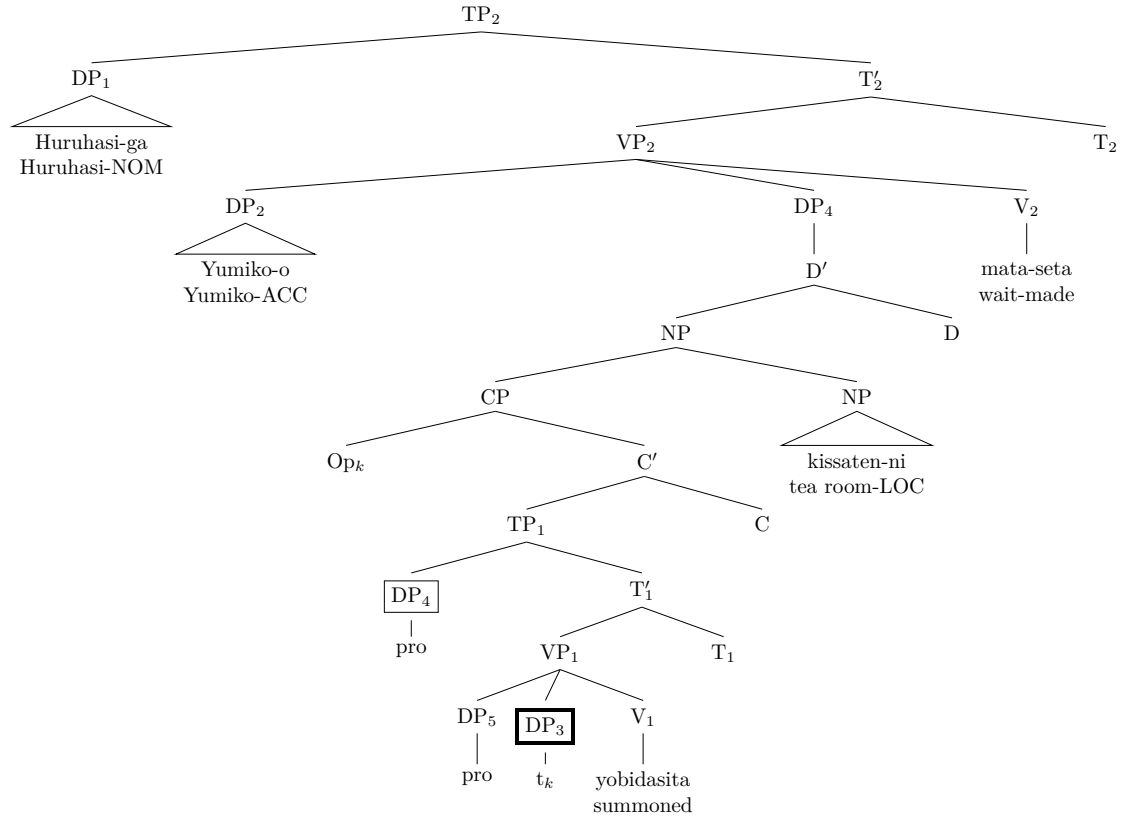

'Huruhasi made Yumiko wait for a long time at the tea room to which he summoned her.'

The reanalysis above includes relocation of the trace (DP<sub>3</sub>) from its position as the subject of the relative clause (marked by a box) to its position of a complement of the verb *summoned* (marked by a bold box). Since its position after reanalysis does not c-command its position prior to reanalysis, the relation  $\text{prec}(\text{DP}_3, \text{T}'_1)$ , that is evident in (224), is falsified and cannot be deleted according to UD. Thus, the garden path effect is correctly predicted.

Note that the above reanalysis is similar to the one assumed to happen during the processing of (187) as demonstrated in (192) in section 6.3. That is, in both cases the parser is assumed to pursue a subject analysis and then reanalyze it to an object relative. The interesting difference between the sentence above and previous Japanese examples such as (187), as mentioned above, is that the reanalysis in (225) is triggered only by the appearance of the verb (*wait-made*). In the previous examples, the reanalysis was triggered prior to the appearance of the matrix verb, namely when the parser encountered the modified NP, since the null-displacement interpretation was incompatible with the sentence, even before the appearance of the verb.

Let us now consider the following contrast:

- (226) a.  ${}_{OK}\emptyset$  Yumiko-o yobidasita kissaten-ni nagai koto mata-seta.  
 $\emptyset$  Yumiko-ACC summoned tearoom-LOC long time wait-made  
 '∅ made Yumiko wait for a long time at the tea room to which (s)he summoned her.'  
 -Mazuka & Itoh (1995) (18b)
- b.  ${}_{GP}$ Huruhasi-ga Yumiko-o yobidasita kissaten-ni nagai  
 Huruhasi-NOM Yumiko-ACC summoned tearoom-LOC long  
 koto mata-seta.  
 time wait-made  
 'Huruhasi made Yumiko wait for a long time at the tea room to which he summoned her.'

Sentence (219) above is repeated as (226b), allowing us to see that the difference between the two sentences in (226) is the matrix subject. Whereas (226b) includes a phonetically realized element as its subject, (226a) includes a phonetically unrealized subject. Let us consider the process of parsing (226a).

By the time the parser reaches *summoned*, the following clause can be computed:

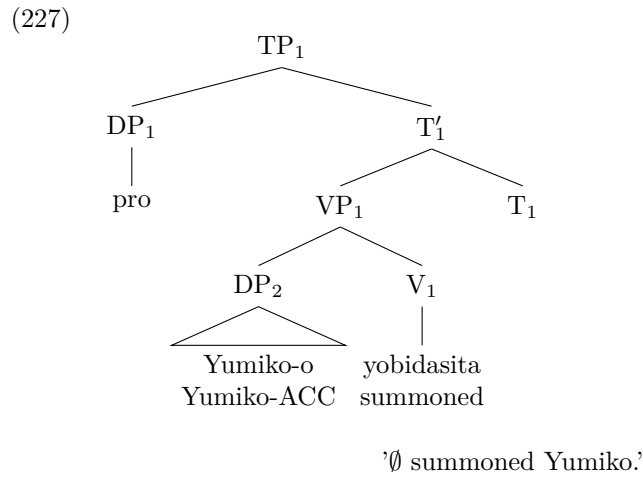

When the parser encounters *tearoom*, the clause described in (227) is attached as a relative clause modifying this NP (complying with Minimal Expulsion Strategy):

(228)

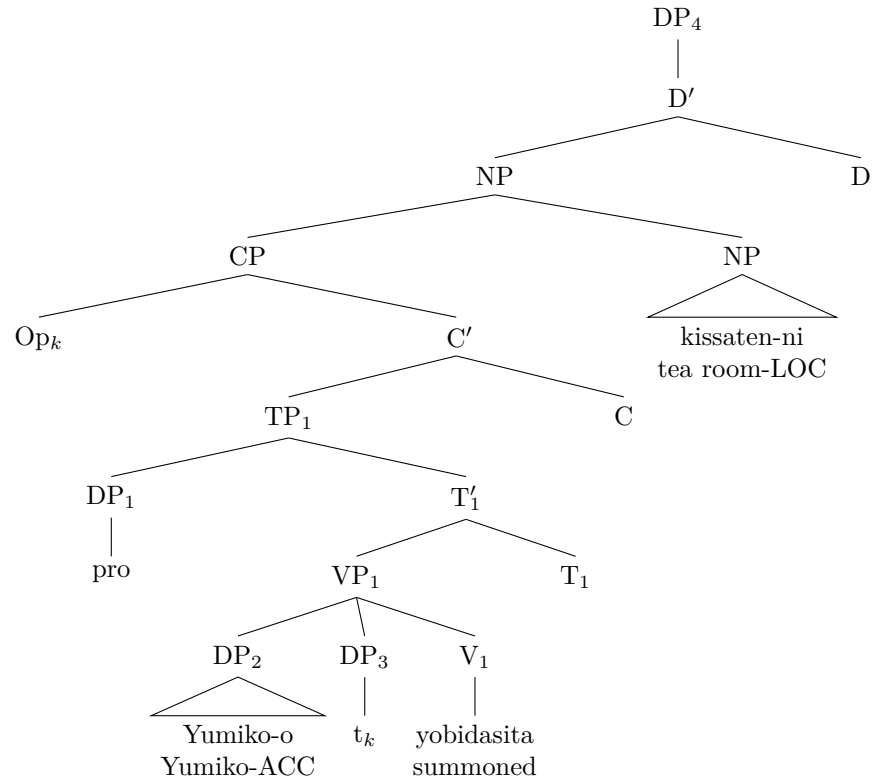

'The tea room where  $\emptyset$  summoned Yumiko.'

When *wait-made* is encountered, it becomes clear that a reanalysis is required. Since *wait-made* is a transitive verb, the parser projects the following structure (I omit the adverb *long time* for simplicity):

(229)

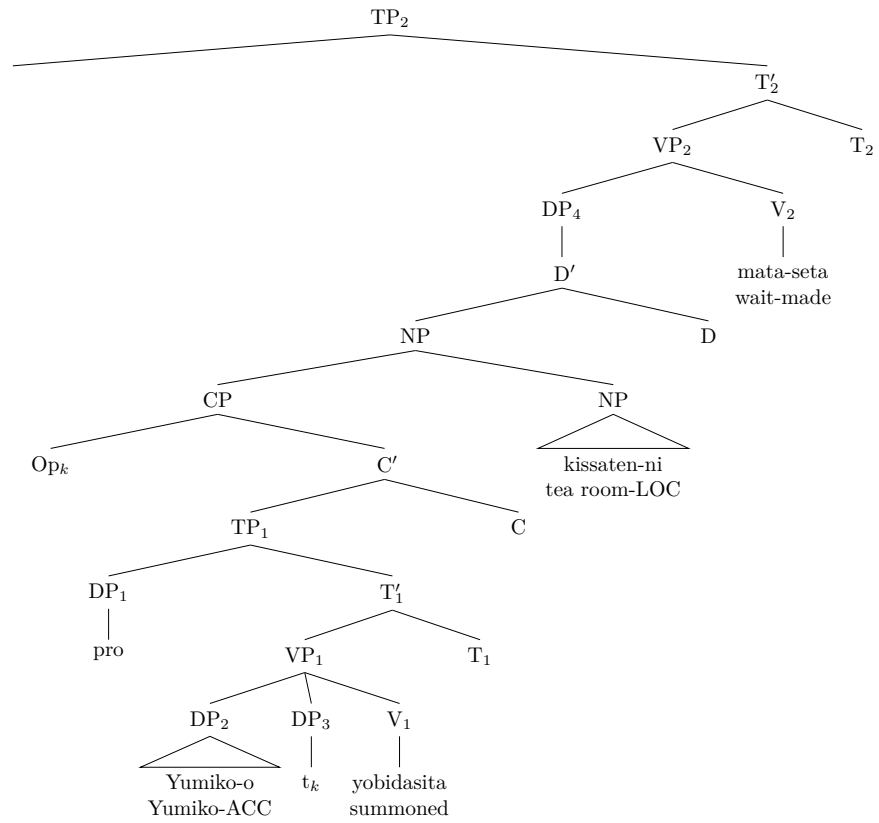

*wait-made* requires an external argument, and its position (that is, [Spec TP<sub>2</sub>]) is empty. In contrary to (226b), there is no phonetically realized NP that can be relocated to this position, and thus a phonetically unrealized subject is posited:

(230)

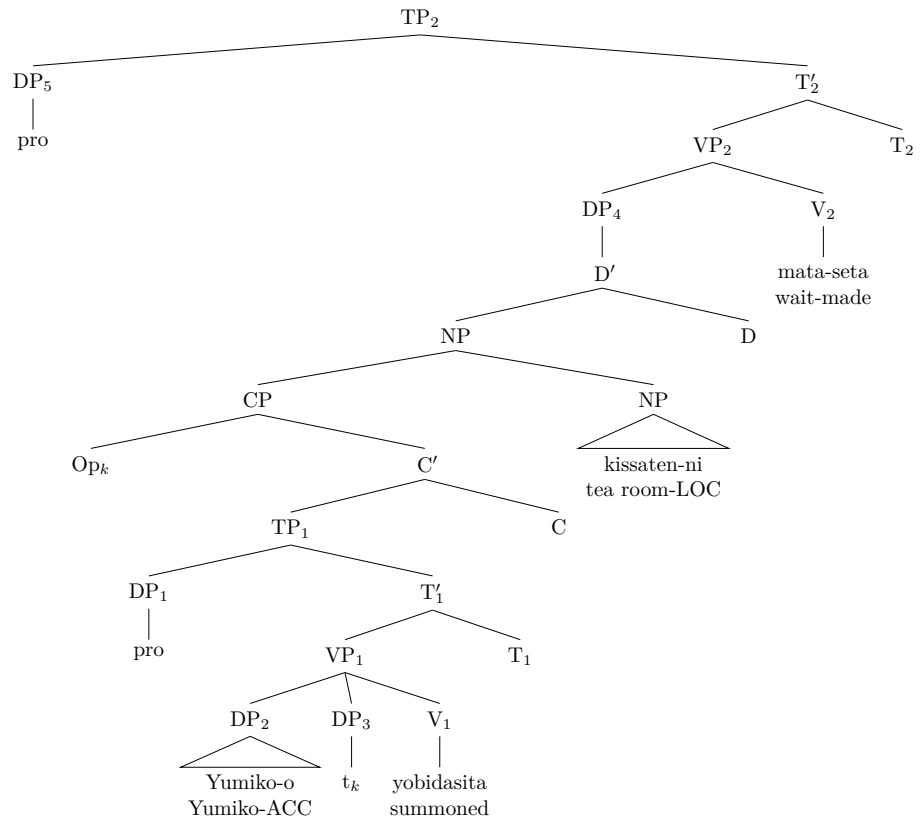

'(s)he made the tea room to which he summoned Yumiko wait for a long time.'

Since *wait-made* assigns an accusative Case, *tea room-LOC* is not a suitable internal argument for this verb<sup>61</sup> (consider the meaning represented by the structure in (230)). Thus, the parser can pursue one of two options:

- (231) a.  $\emptyset_i \emptyset_j [\emptyset_k \text{ Yumiko-o } \text{ yobidasita } \text{ kissaten-ni}_k]$  *nagai koto*  
 $\emptyset_i \emptyset_j [\emptyset_k \text{ Yumiko-ACC summoned tearoom-LOC}_k]$  *long time*  
*mata-seta.*  
*wait-made*  
 ' $\emptyset_i$  made  $\emptyset_j$  wait for a long time at the tea room to which (s)he<sub>i</sub>  
 summoned Yumiko.'
- b.  $\emptyset_i \text{ Yumiko-o } [\emptyset_k \text{ yobidasita } \text{ kissaten-ni}_k]$  *nagai koto*  
 $\emptyset_i \text{ Yumiko-ACC } [\emptyset_k \text{ summoned tearoom-LOC}_k]$  *long time*  
*mata-seta.*  
*wait-made*

<sup>61</sup>In addition, *wait-made* selects for an animate object.

' $\emptyset_i$  made Yumiko wait for a long time at the tea room to which (s)he<sub>i</sub> summoned her.'

According to Least Gap Strategy, the parser prefers (231b). Therefore, an object relative clause is created:

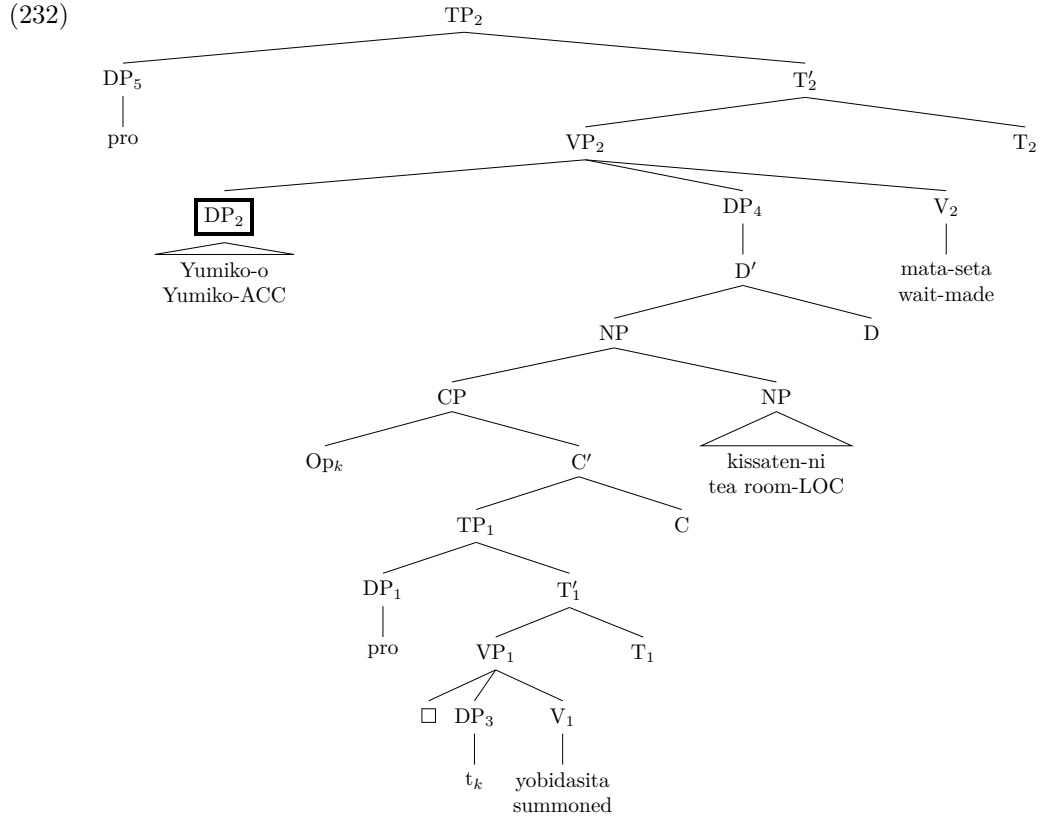

' $\emptyset$  made Yumiko wait for a long time at the tea room to which (s)he summoned her.'

The relocation of *Yumiko* is not assumed to result in a garden path effect according to Unconscious Deletion, since the new position of *Yumiko* as a complement of the matrix verb (marked by a bold box) c-commands its original position as a complement of the embedded verb (marked with an empty box). Therefore, the relation  $\text{dom}(\text{VP}_1, \text{DP}_2)$  is deleted, and the right structure is computed without resulting in a processing breakdown.

Note that the difference between (226a) and (226b) above, highly resembles the difference between (194a) and (194b) (repeated below):

- (233) a.  $\text{OK} \emptyset$  kodomo-o koosaten-de mikaketa takusii-ni noseta.  
 $\emptyset$  child-ACC intersection-LOC saw taxi-DAT put-on

'∅ put the child on the taxi (s)he saw at the intersection.'

-Mazuka & Itoh (1995), (18a)

- b. <sub>GP</sub>Yoko-ga kodomo-o koosaten-de mikaketa takusii-ni  
 Yoko-NOM child-ACC intersection-LOC saw taxi-DAT  
 noseta.  
 put-on  
 'Yoko put the child on the taxi she saw at the intersection.'

The difference seems to be that while sentences (226b) and (233b) include a phonetically realized subject, sentences (226a) and (233a) have a phonetically unrealized subject. According to our assumptions, this difference causes the parser to first adopt a subject-relative analysis in sentences (226b) and (233b), an analysis which turns out to be wrong and one that the parser fails to later reanalyze. That differs from sentences (226a) and (233a), where the parser pursues an object-relative analysis without first committing to a subject-relative analysis. So, we explain the fact that (226b) and (233b) result in a garden path effect while (226a) and (233a) do not, by counting on the same claims.<sup>62</sup> Under the current proposal, the important factor is not whether the reanalysis is invoked by a theta-assigner or a non theta-assigner, but rather the structural relations that are modified during the reanalysis.

#### 6.4.2 Garden Path sentences involving scrambling in Korean

Let us consider the following contrast attested in Korean, taken from Hwang & Schafer (2009):

- (234) a. <sub>OK</sub>Phigules-i Lopin-eykey Phwuwu-ka ttacwu-n pelcip-ul  
 Piglet-NOM Robin-DAT Pooh-NOM pick-REL honeycomb-ACC  
 unkunsulccek phalapelyessta  
 stealthily sold  
 'Piglet stealthily sold [the honeycomb [that Pooh picked]] to Robin.'
- b. <sub>GP</sub>Phigules-i Lopin-eykey Phwuwu-ka ttacwu-n pelcip-ul  
 Piglet-NOM Robin-DAT Pooh-NOM pick-REL honeycomb-ACC  
 Thige-eykey phalapelyessta  
 Tigger-DAT sold  
 'Piglet sold Tigger [the honeycomb [that Pooh picked for Robin]].'

Let us consider the process of parsing (234a). The parser first encounters *Piglet*, and attaches it to the matrix subject position (complying with Strict Incrementality). Then, the parser reaches *Robin*, and attaches it as a complement of the (yet to appear) matrix verb. Even though *Robin* could turn out to be in a scrambled position, MCP predicts that the initial analysis will avoid postulating

<sup>62</sup>This differs from Mulders (2002), which assumes a constraint on the rebuffering mechanism to explain the difference between parsing (233a) and (233b), and suggests a different explanation to account for the difference between sentences (226a) and (226b).



a chain - that is, assume that *Robin* appears in its canonical position. When the parser reaches *Pooh*, this DP is posited in a subject position of a subordinate clause, since it is marked with a nominative Case:

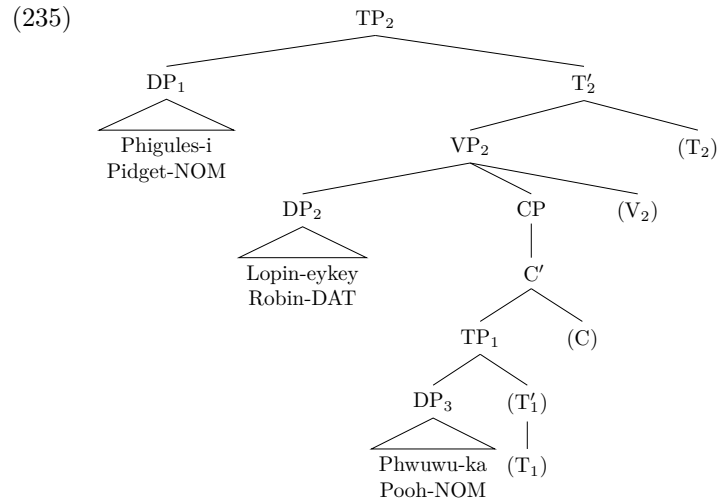

Next, the parser encounters *pick*, along with a particle indicating that a relative clause has been introduced. When *honeycomb* is encountered, this NP is adjoined to the tree, modified by the relative clause “that Pooh picked”. That is, the following structure has been computed:

(236)

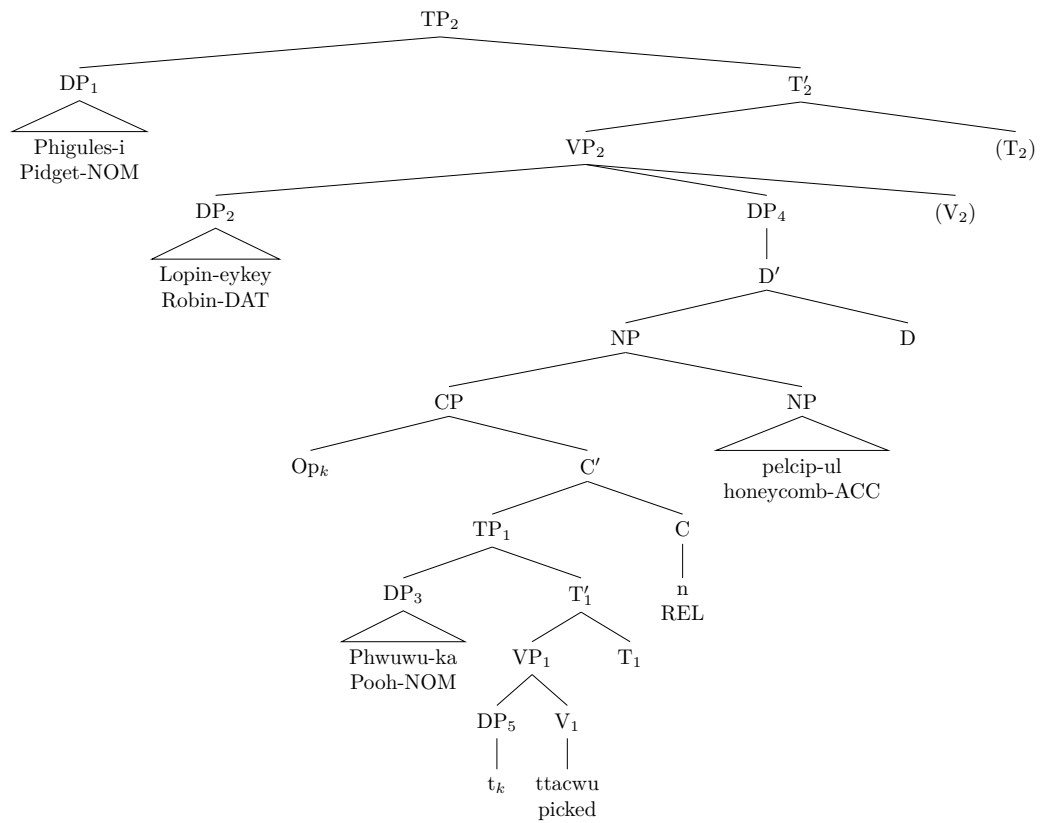

'Piget... [the honeycomb [that Pooh picked]] to Robin'

At this point, the parser encounters the adverb *stealthily* and adjoins it to the VP (I will omit it from the trees below for simplicity's sake). Finally, the matrix verb *sold* is encountered, and the final structure is computed with no need for reanalysis:

(237)

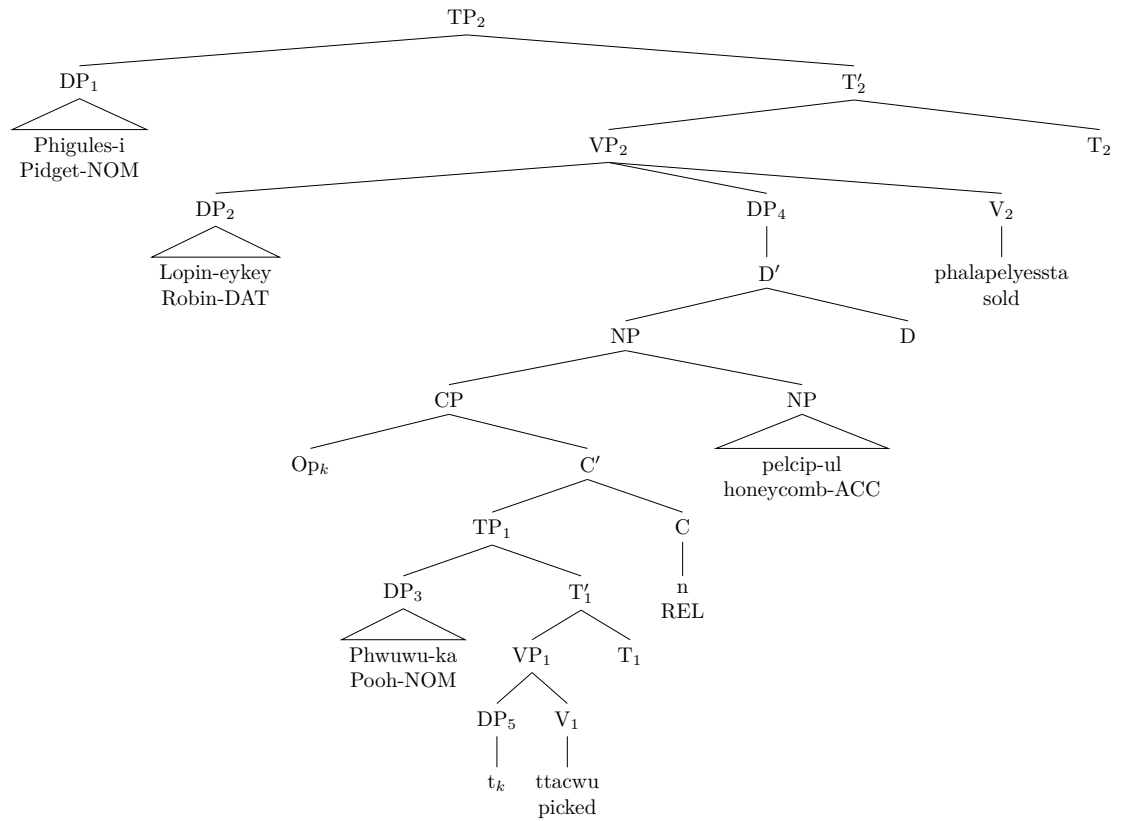

'Piget sold [the honeycomb [that Pooh picked]] to Robin'

Note that the string in (234a) is actually globally ambiguous - due to the free word order in Korean, it is possible to interpret *Pidget* as being in a scrambled position, and then the meaning of the sentence would be 'Piget stealthily sold [the honeycomb [that Pooh picked for Robin]]'. Yet, the meaning consisting of the canonical word order is highly preferred, as demonstrated both in an eye-tracking study by Koh (1997), and a self-pace reading study by Kiaer (2007). As claimed above, this preference is accounted for by assuming the MCP - that is, the parser does not postulate a chain unless it is necessary to. Since processing (234a) involves no reanalysis, it is correctly predicted that this sentence does not invoke a garden path effect.

Let us now consider (234b). The string in this sentence is identical to the one in (234a) up to and including the *honeycomb*, so we can assume that the parsing is also identical up to this point. That is, the parser yields the structure shown in (236). At this point, a second dative-marked DP appears, *Tigger*. Hwang & Schafer (2009) explain that this DP forces a reanalysis, since the matrix clause cannot have two dative arguments. That is, *Robin* must be reanalyzed from its position as an argument to the matrix verb, to a part of the relative clause modifying the *honeycomb*, yielding the following structure:

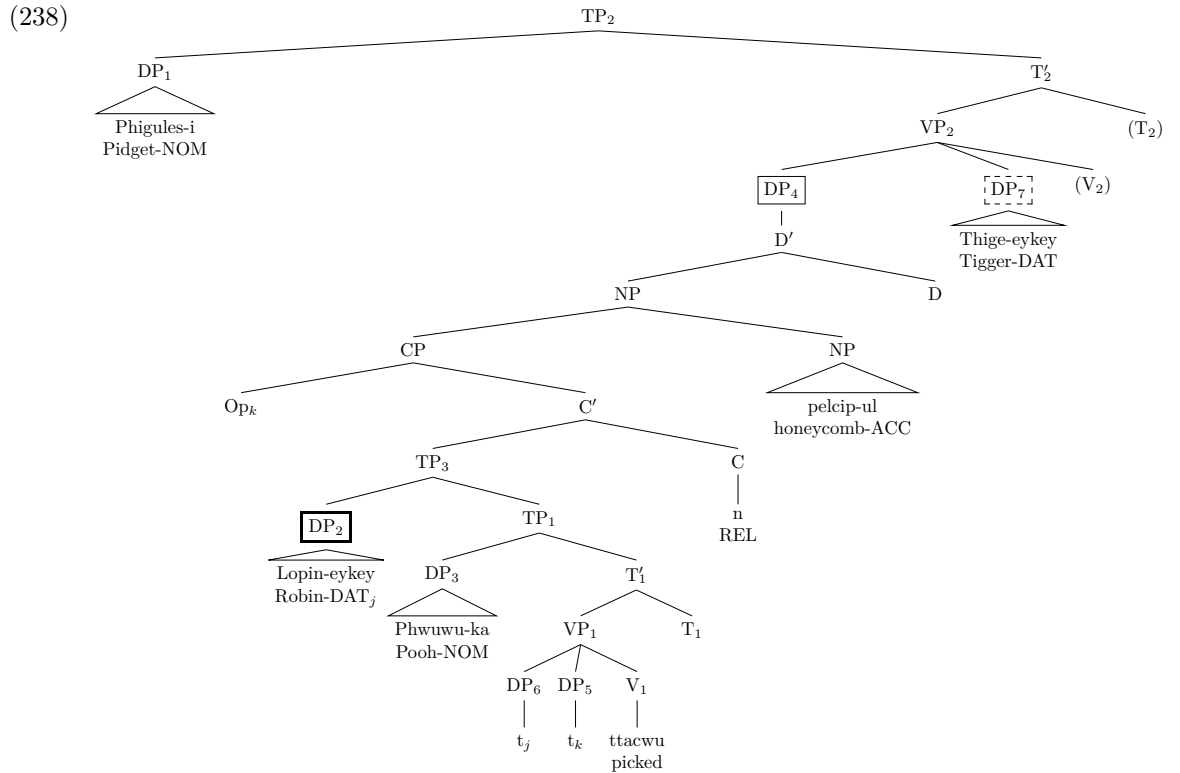

'Piget... [the honeycomb [that Pooh picked for Robin]]... to Tigger'

Hwang & Steinhauser (2011) report this sentence to cause a garden path effect. This fact is accounted for given our assumptions. Note that *Robin* has been relocated from its position as an argument to the matrix verb (marked with a box) to its position as adjoined to the embedded TP (marked with a bold box). In addition,  $DP_4$  must be relocated from its position as a second argument of the matrix verb (marked with a dashed box) to the position of the first argument of the matrix verb (which is the same position as *Robin*'s original position, marked with a box). Since the new position of  $DP_4$  c-commands its original position, the relation  $\text{prec}(DP_2, DP_4)$ , which was evident in (236), is erased according to Unconscious Deletion. However, the relation  $\text{prec}(DP_2, CP)$ , which was evident already in (235),<sup>63</sup> cannot be erased according to UD - as CP's new position does not c-command its original position (which does not exist in the structure, but has been embedded under what is  $DP_7$ ). This relation is no longer valid in (238), and hence the sentence is correctly predicted

<sup>63</sup>Note that this relation is indeed a part of the tree description. This relation has been added in state (235) according to Element Attachment defined in (171), since in this state CP was attached to the structure, and  $DP_2$  was a sister of CP. In section 8.3 I show that assuming a VP-shell structure, it is a *dominance* relation that exists in the description and cannot be erased according to UD.

to result in a processing breakdown.

While the processing of (234b) includes no deletion, but rather a relocation - this relocation is not permitted and thus the fact that it yields a garden path effect is also accounted for under our assumptions.

## 6.5 Processing phenomena other than garden path

The current proposal can also account for processing phenomena other than garden path. One such example is processing of local Subject-Object ambiguities in languages such as German or Dutch. Below I provide an illustration as to how the current proposal may account for the data, and not a thorough examination. Consider the following example:

- (239) a. Die Direktorin hat erzählt, daß sie einige der Kollegen  
The director has said, that she some the colleagues  
angerufen hat.  
phoned has  
'The director said that she phoned some of the colleagues.'
- b. Die Direktorin hat erzählt, daß sie einige der Kollegen  
The director has said, that she some the colleagues  
angerufen haben.  
phoned have  
'The director said that some of the colleagues phoned her.'  
-Bader & Meng (1999), (6)

The strings in (239a) and (239b) are identical up to the last word. Both sentences are completely grammatical in German, and neither of them causes a conscious garden path effect. The local ambiguity arises when the parser encounters the feminine singular pronoun *sie*. As described in section 5.1, *sie* in German is ambiguous between nominative and accusative Case. This ambiguity is resolved by the agreement features of the auxiliary at the end of the clauses. That is, when the auxiliary verb is *has*, as in (239a), the nominative reading turns out to be the correct one, as *has* ('*hat*') can only agree with *sie*, and not with the plural noun *some of the colleagues*. However, in case the auxiliary verb is *have* ('*haben*'), then this auxiliary can only agree with the plural noun *some of the colleagues*, and thus only the accusative reading is valid.<sup>64</sup>

Evidence from Dutch (Frazier (1987)) as well as from German (e.g., Schriefers, Friederici & Kuhn (1995), Bader & Meng (1999)) suggests that there is a preference for the reading with the subject preceding the object. For example,

---

<sup>64</sup>As Bader & Meng (1999) explain, the pervasiveness of subject-object ambiguities in German is possible as a result of a number of syntactic and morphological properties. First, German has a subject-object-verb base order, which is conspicuous in embedded clauses. Therefore in embedded clauses the finite verb follows all arguments. "Furthermore, German enjoys a relatively free word order. Certain syntactic operations like topicalization or scrambling [...] may change the order of arguments both in main and embedded clauses." Additionally, the morphological ambiguity of relevant pronouns (e.g., *sie*) plays an important role in creating the local ambiguity.

psycholinguistics studies reveal that the reading times for sentences with the subject reading (as in (239a)) are faster than those of sentences with object reading (as in (239b)). Bader & Meng (1999) examined four types of locally ambiguous clauses in German and found a consistent preference for the subject reading, regardless of sentence type.

Let us consider the processing of the embedded clause in (239a) given the assumptions suggested in this paper. The matrix clause is identical between (239a) and (239b). As the parser encounters the complementizer *that*, an embedded clause is constructed (as the complement of the matrix verb, *said*). When the parser reaches *sie*, it faces the local ambiguity described above.

If the parser chooses the nominative reading, it constructs the following structure:

(240)

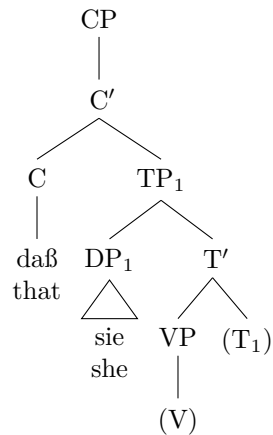

The structure above includes no chains. However, if the parser pursues the accusative reading, then the following structure must be constructed:

(241)

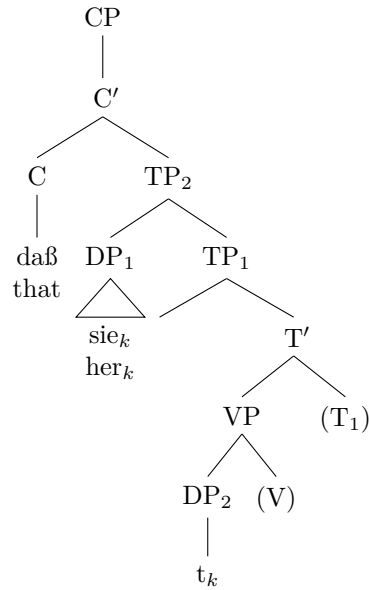

Since (241) includes a chain, and (240) does not, MCP clearly states that the latter is the preferred analysis to be adopted by the parser. Next, the parser will attach *some of the colleagues* as a complement of the embedded verb. When the parser reaches the embedded verb *phoned*, it can be attached to V. The following structure is thus constructed:

(242)

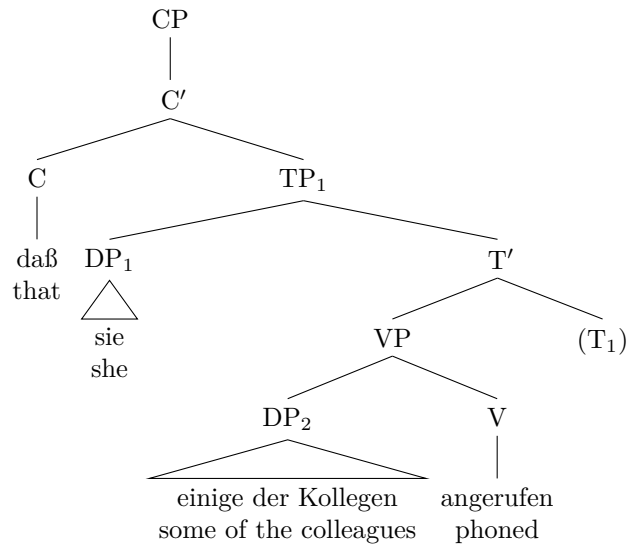

Up to this point, the strings in (239a) and (239b) are identical, so the above analysis is the one assumed to be generated while parsing either sentence. If the

sentence ends with *has* ('hat'), as in (239a), then this auxiliary can be attached to T, and no reanalysis is required. However, if the string terminates with *haben* ('has'), then the structure in (242) must be revised. Specifically, since this auxiliary does not agree with the element in the subject position, namely *sie*, this element must be relocated, adjoined to TP<sub>1</sub>:

(243)

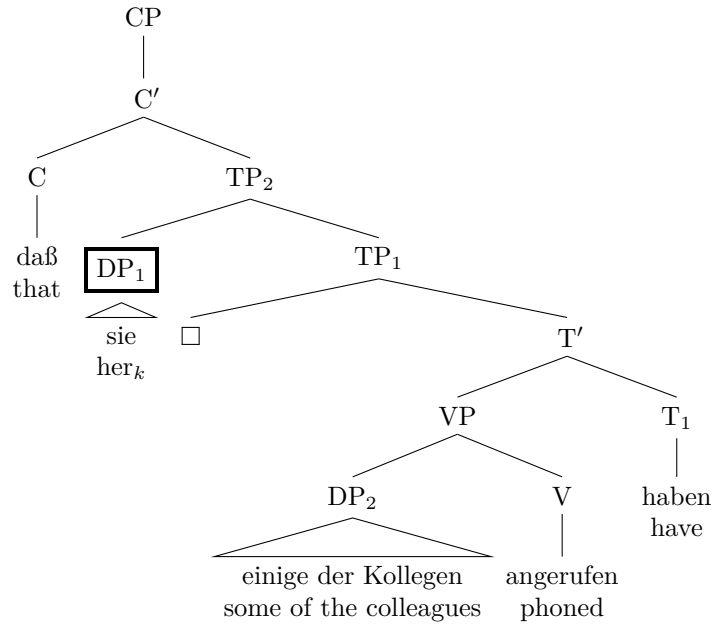

*sie* (DP<sub>1</sub>) has been relocated from its position as the subject ([Spec TP<sub>1</sub>], marked with an empty box) to the adjoined position (marked with a bold box). Since its position after reanalysis c-commands its position before reanalysis, the relation of dom(TP<sub>1</sub>, DP<sub>2</sub>) is deleted according to Unconscious Deletion. Yet, at this point, the subject position is empty, and a plural subject is required. Therefore, another relocation takes place:



(244)

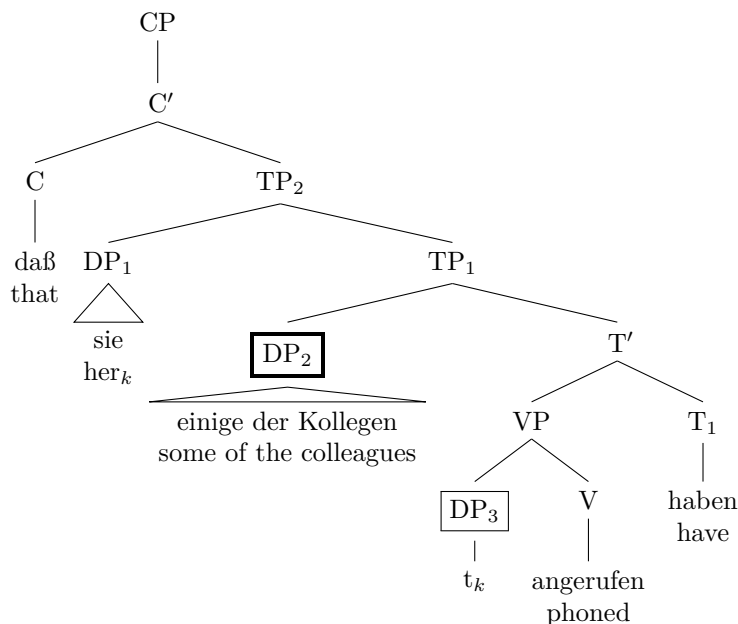

'The director said that some of the colleagues phoned her'

The relocated element is *some of the colleagues* (DP<sub>2</sub>), which moved from its position as a complement of the verb (marked with a box) to the subject position (marked with a bold box). In this relocation as well, the new position of the relocated element c-commands its original position, and thus the relation  $\text{dom}(\text{VP}, \text{DP}_2)$  is erased. According to UD, the sentence is correctly predicted not to result in a garden path effect.<sup>65</sup> In addition, since the processing of (239b) is predicted to involve reanalysis, which is not assumed to happen when processing (239a), it is also predicted that (239b) will be harder to process. Thus, the subject-reading preference is accounted for under the current proposal.

## 6.6 Predictions that stem from the current proposal - easy displacements

The current proposal yields predictions regarding constructions that have not been discussed in the literature, according to my knowledge. In previous sections (e.g., section 6.3), we have seen cases where displacements, and specifically double-displacements yield a garden path effect. Specifically, sentences consisting of the canonical order (that is, without topicalization) seemed to be hard to process when involving displacements. Even more specifically, these sentences tended to include relative clauses. Yet, our assumptions do not predict that

<sup>65</sup>Under Structural Determinism, neither of the deletions described are possible, and thus the sentence is wrongly predicted to result in a garden path effect.

every displacement (including double-displacement) will result in a processing breakdown, even if the sentence consists of the canonical word order, or if there is no relative clause involved.

Given the assumptions described in previous sections, let us consider the following sentence:

- (245) Nanako-ga<sub>i</sub> kodomo-ni  $\emptyset_i$  tegami-o okuru to itta.  
 Nanako-NOM<sub>i</sub> child-DAT  $\emptyset_i$  letter-ACC send that said  
 'Nanako said that she would send the child a letter.'

Let us consider the processing of the sentence above. The parser attaches *Nanako*, *child* and *letter* to the syntactic tree. After encountering the verb *send*, the following structure has been computed:

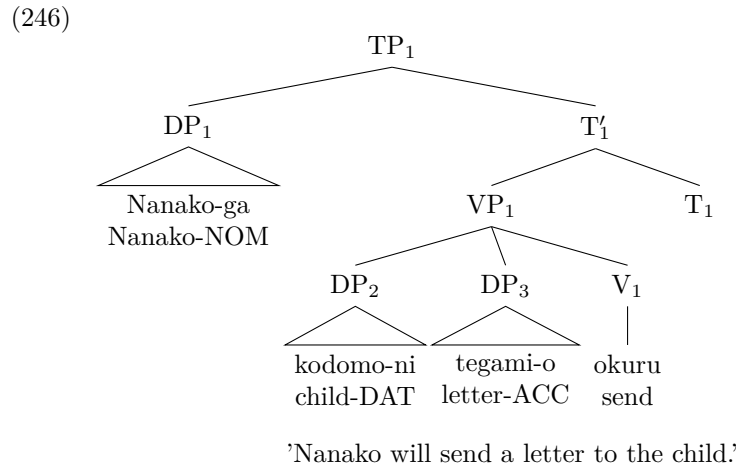

At this point, the parser encounters the complementizer *that*, which is attached to the structure:

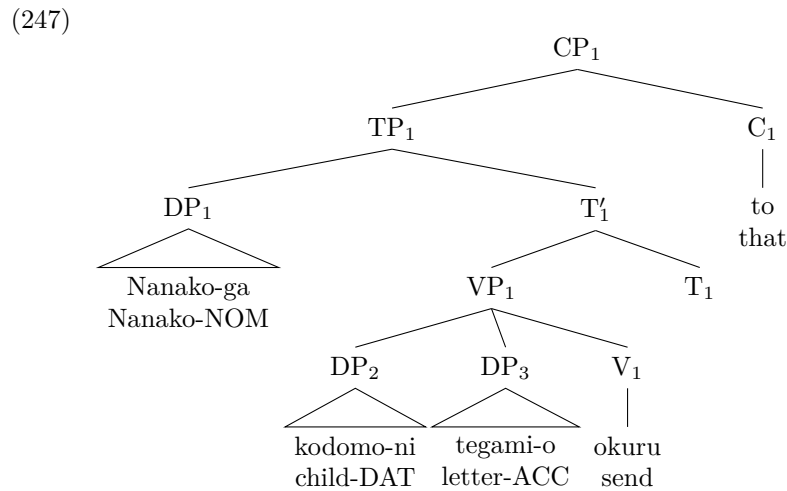

'That Nanako will send a letter to the child.'

At this point, the parser encounters the matrix verb, *said*. Consequently, the above analysis is falsified and a reanalysis is required. Complying with Licensed Lexical Projection, merging *said* results in projecting one external argument. Consequently, *Nanako* is extracted:

(248)

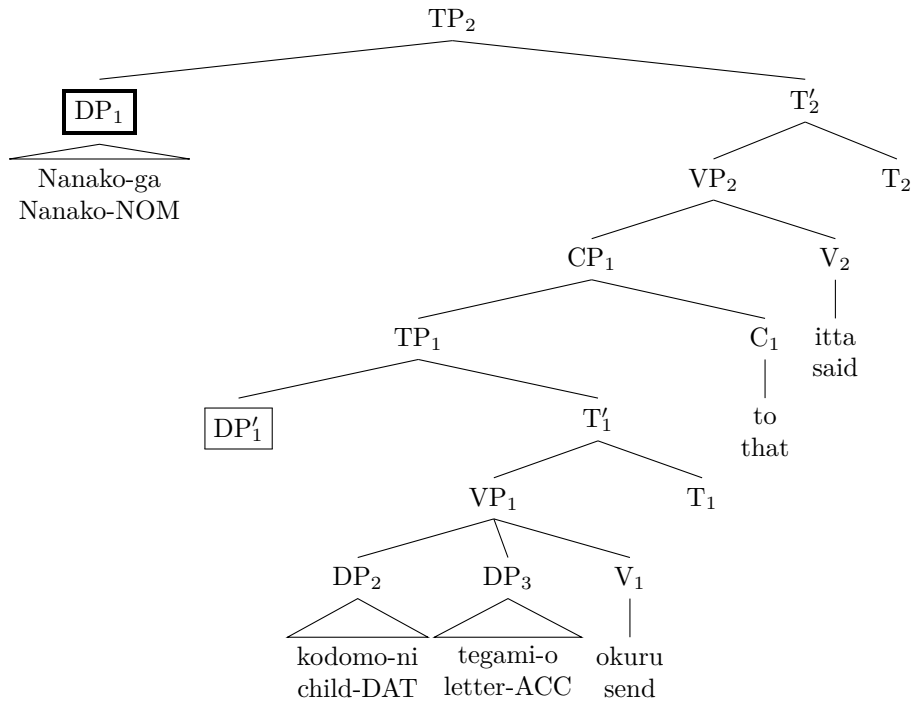

'Nanako said that ... would send a letter to the child.'

This relocation of *Nanako* is permitted by Unconscious Deletion - as the new position of *Nanako* as the matrix subject (marked by a bolded box) c-commands its original position as the subject of the subordinate clause (marked by a box). Thus, the relation  $\text{dom}(\text{TP}_1, \text{DP}_1)$  that was evident in (247) is deleted.

At this stage, since the embedded subject position is empty, a *pro* is inserted, resulting in the following structure:

(249)

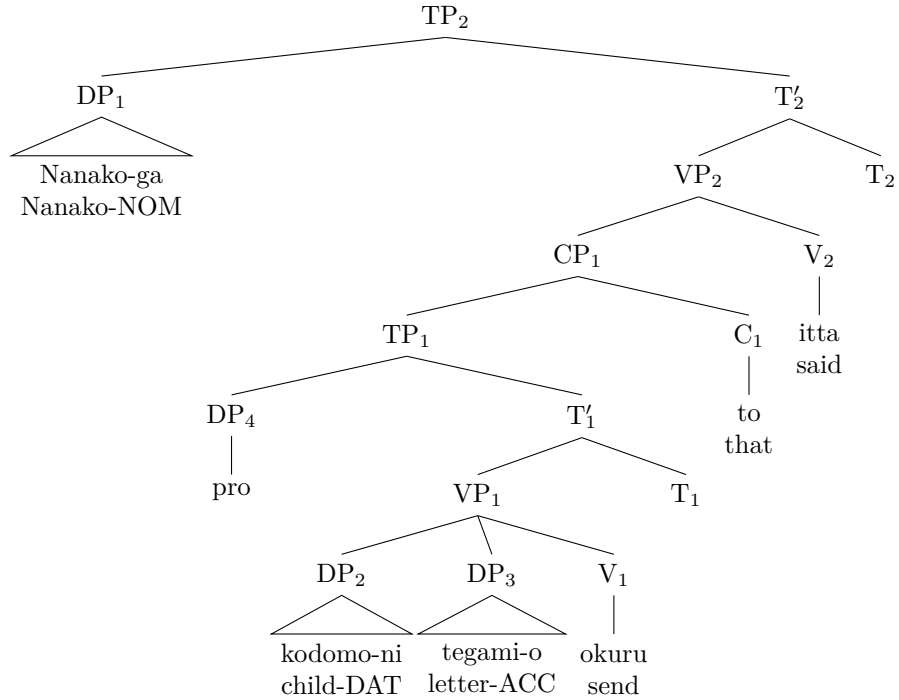

'Nanako said that she would send a letter to the child.'

Since no relation has been falsified, with the exception of the relation that was deleted according to UD, we correctly predict (245) to be processed without yielding a garden path effect. Note that we predict easy processing even though this sentence includes relocation of an element (namely, *Nanako*) upon the appearance of the main verb. Moreover, (245) seems to reflect application of Unconscious Deletion for a construction other than a relative clause, namely that of a sentential complement.

This sentence does not seem to result in a garden path effect (Nanako Kojima, p.c.), but further investigation is necessary in order to validate this.

Perhaps a more interesting case would include relocation of two elements, that is, double-displacement. Let us consider the following sentence.

- (250) Mary-ga kasa-o katta hito-kara toriageta.  
Mary-NOM umbrella-ACC bought person-from took-away  
'Mary took away the umbrella from the person who bought it.'  
-Inoue (1991) (16)

The sentence above is taken from Inoue (1991), but it is not reported whether it induces a garden path effect. Let us consider the processing of this sentence given our assumptions. As we will notice, according to the current proposal, this sentence is not predicted to yield a garden path effect, even though it

includes a reanalysis when a non theta-assigner is encountered, as well as double-displacement.

At the point the parser encounters the verb *bought*, the parser constructs the following clause:

(251)

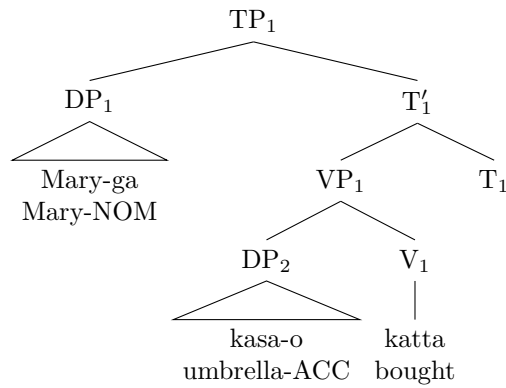

'Mary bought an umbrella.'

Next, the parser encounters *person-from*, and the clause in (251) turns out to be a relative clause modifying the noun *person*. Since a null-displacement is impossible ('the person where/when Mary bought an umbrella'), the parser pursues a single-displacement analysis. That is, *Mary* is displaced from within the relative clause to the position of the subject of the matrix clause:

(252)

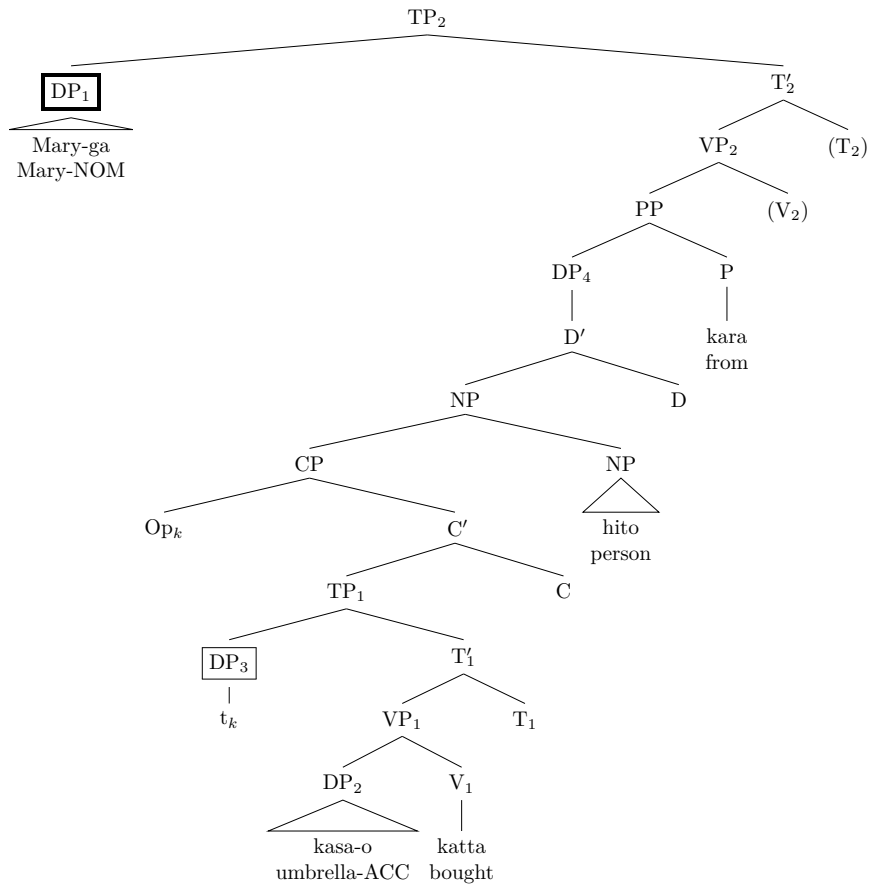

'Mary... From the person who bought the umbrella'

Since the position of *Mary* as the subject of the matrix clause (marked with a bold box) c-commands its original position as the subject of the subordinate clause (marked with a box), the relation  $\text{dom}(\text{TP}_1, \text{DP}_1)$  is deleted according to UD, and a garden path effect is not predicted to arise. Now, the parser encounters *took-away*, which is a ditransitive verb that selects for a DP as its first argument. The parser now has two options:

- (253) a. Mary-ga *kasa - o<sub>j</sub>* [ $\emptyset_k$   $\emptyset_j$  katta hito<sub>k</sub>]-kara  
 Mary-NOM umbrella-ACC<sub>j</sub> [ $\emptyset_k$   $\emptyset_j$  bought person<sub>k</sub>]-from  
 toriageta.  
 took-away  
 'Mary took away the umbrella<sub>j</sub> from the person who bought it<sub>j</sub>.'
- b. Mary-ga  $\emptyset_j$  [ $\emptyset_k$  kasa-o katta hito<sub>k</sub>]-kara toriageta.  
 Mary-NOM  $\emptyset_j$  [ $\emptyset_k$  umbrella-ACC bought person<sub>k</sub>]-from took-away

'Mary took away  $\emptyset$  from the person who bought the umbrella.'

Since (253b) includes an unlicensed phonologically unrealized argument, a parser employing Least Gap Strategy prefers (253a). Inoue (1991) indeed reports the string in (250) as in the meaning described in (253a). In order to yield (253a), the parser relocates *umbrella* from within the subordinate clause:

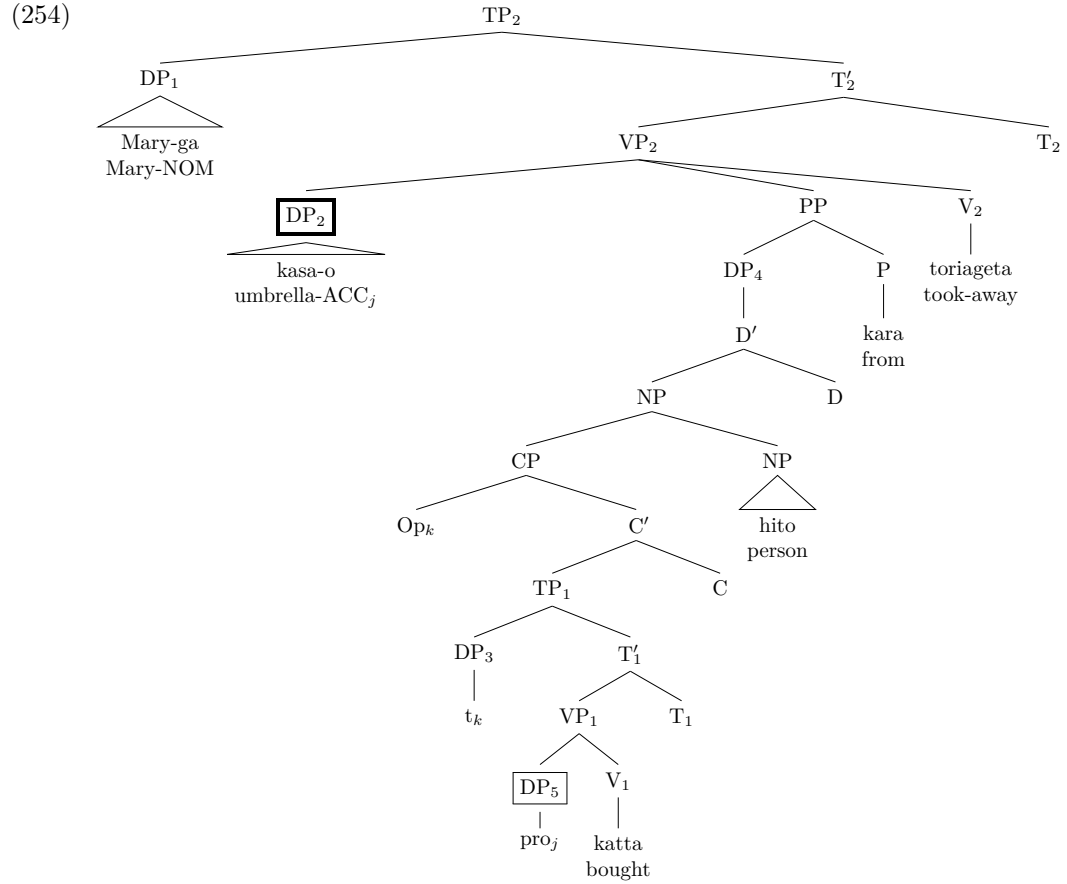

'Mary took away the umbrella<sub>j</sub> from the person who bought it<sub>j</sub>.'

The relation  $\text{dom}(\text{VP}_1, \text{DP}_2)$  is deleted according to Unconscious Deletion, since the position of *umbrella* following reanalysis (that is, as a complement of *took-away*) c-commands its original position as a complement of *bought*. Thus, the relocation of *umbrella* is not predicted to result in a garden path effect, and the entire sentence as a whole is predicted to be processed without yielding a processing breakdown.

Sentence (250) is particularly interesting, as according to the current analysis it is predicted to be parsed easily even though its processing presumably involves relocation of two elements from within the subordinate clause, and that these

elements are posited in a canonical order. In fact, (250), repeated below as (255a) is similar to (187), repeated below as (255b):

- (255) a. Mary-ga kasa-o katta hito-kara toriageta.  
 Mary-NOM umbrella-ACC bought person-from took-away  
 'Mary took away the umbrella from the person who bought it.'
- b. <sub>GP</sub>Yoko-ga kodomo-o koosaten-de mikaketa takusii-ni  
 Yoko-NOM child-ACC intersection-LOC saw taxi-DAT  
 noseta.  
 put-on  
 'Yoko put the child on the taxi she saw at the intersection.'

Both sentences in (255) include a matrix clause that consists of a ditransitive verb. The second internal argument of that verb includes a relative clause. According to our assumptions, during the process of parsing each of these sentences, two elements are relocated from within the embedded clause (that is first analyzed as a matrix clause). Yet, while (255a) is predicted to be easy to parse (a prediction that should be tested), (255b) yields a garden path effect. The crucial difference between these sentences is that while in (255a) the parser does not need to reanalyze its subject relative clause analysis, in (255b) the parser has to reanalyze a subject relative clause into an object relative clause, as described in section 6.3.

## 7 Unconscious Deletion in head-initial languages

In previous sections, and specifically in section 6.3, we have seen various examples where a relation is deleted according to Unconscious Deletion during processing of head-final languages. Yet, given that Unconscious Deletion is indeed a mechanism available for the human processor, we would expect it to be used in head-initial languages as well, even if less frequently. In this section I shall describe a few cases in head-initial languages where Unconscious Deletion seems to play a role.

### 7.1 Ambiguous “her”

Recall sentences (38), taken from Pritchett (1992) and repeated below as (256):

Consider the following two sentences, :

- (256) a. <sub>OK</sub>They gave her books.  
 b. <sub>OK</sub>They gave her books to Ron.

As noted in section 4.1.2, neither of the sentences above causes a garden path effect. Let us consider how this fact can be accounted for given the current proposal. While processing either of these sentences, the parser first encounters *They*, and attaches it to the phrase structure given Strict Incrementality. When it encounters *gave*, the parser attaches it at the matrix verb, and projects



two complement positions according to Licensed Lexical Projection. When the parser encounters *her*, it can attach it as a direct object of *gave*. The following structure is thus computed:

(257)

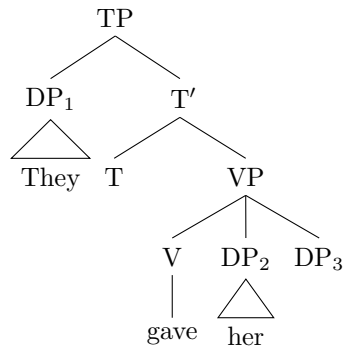

Now, the parser encounters *books*, and can attach it to *gave*'s second internal argument position.

(258)

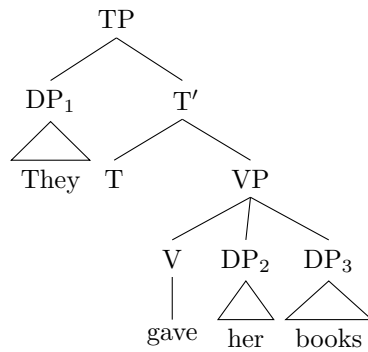

(256a), has been successfully parsed. However, the sentence may continue, as in (256b). When the parser reaches *to Ron*, the initial analysis must be revised, as *to Ron* must be attached to the structure. The requested reanalysis results in the following structure:

(259)

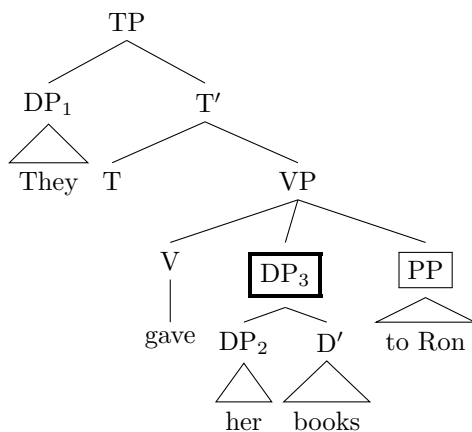

Prior to reanalysis, the relation  $\text{prec}(\text{DP}_2, \text{DP}_3)$  existed in the tree description. Yet, according to Unconscious Deletion, this relation is erased as  $\text{DP}_3$ 's new position c-commands its previous position. This fact is accounted for by Siloni (2004) as well, as depicted in section 4.3.2.

In addition, prior to reanalysis, the relation  $\text{dom}(\text{VP}, \text{DP}_2)$  held. Note that this relation holds after reanalysis as well (even though VP no longer *immediately* dominates  $\text{DP}_2$ ).

## 7.2 Globally ambiguous sentences

Many languages have globally ambiguous sentences, such as the following sentence:

(260) OK The journalist interviewed the daughter of the colonel who had had the accident.

The ambiguity of (260) stems from the fact that the relative clause  $_{CP}$ [who had had the accident] can either modify the daughter, or the colonel. The former is called *high attachment* (because the relative clause is attached higher to the syntactic tree), and the latter is called *low attachment*. Experimental evidence from multiple languages such as Italian (De Vincenzi & Job (1995)) and Japanese (Kamide & Michell (1997)) suggests that readers processing sentences such as (260) pursue low attachment first, but then revise it to a high attachment if necessary. This reanalysis violates Structural Determinism (and thus Structural Determinism wrongly predicts a garden path effect).

Moreover, consider the following example taken from Traxler et al. (1998):

- (261) a. The daughter<sub>1</sub> of the colonel<sub>2</sub> who shot herself<sub>1/\*2</sub> on the balcony had been very depressed.  
b. The daughter<sub>1</sub> of the colonel<sub>2</sub> who shot himself<sub>\*1/2</sub> on the balcony had been very depressed.

- c. The son<sub>1</sub> of the colonel<sub>2</sub> who shot himself<sub>1/2</sub> on the balcony had been very depressed.

All three sentences provided in (261) are (at least) locally ambiguous. Given a parser that employs Strict Incrementality, while parsing sentence (261a) or sentence (261b), the parser has to make an attachment decision when encountering the word *who*. Since the attachment occurs before reaching the anaphor (*herself* in (261a) and *himself* in (261b)), the parser cannot rely on the anaphor in order to make the right attachment decision. Thus, in case the parser makes the wrong attachment decision (e.g., pursues a low attachment analysis in (261a)), a reanalysis will be required. This reanalysis violates Structural Determinism, and thus Structural Determinism wrongly predicts that these sentences will lead to processing breakdown in some cases. However, these sentences do not result in a conscious breakdown. Let us demonstrate how UD can account for this fact.

All three sentences above start with the string “*the daughter of the colonel*”, which is unambiguously analyzed as follows:

(262)

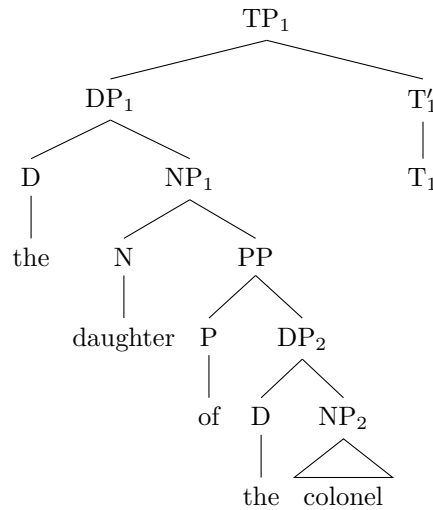

According to Strict Incrementality, once the word *who* is encountered - it must be attached. Specifically for English, Carreiras & Clifton (1999) among others have shown a preference for low attachment. That is, native English speakers first attach the relative clause as a modifier of the *colonel*:

(263)

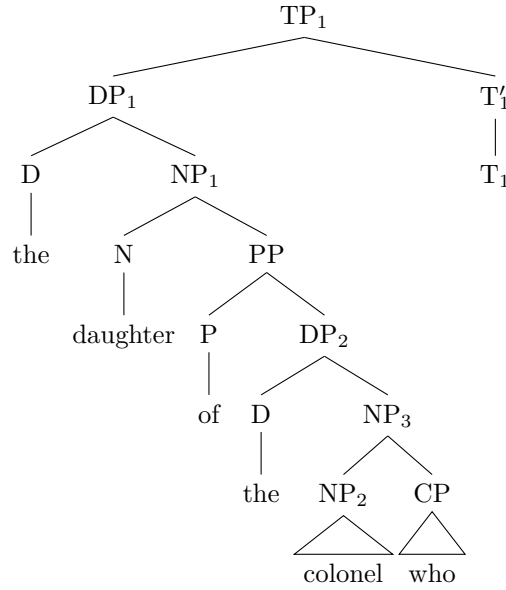

In case the sentence continues as in (261b), the above analysis is compatible with this continuation, and the relative clause can be constructed accordingly. If, however, the sentence continues as in (261a), this CP has to be relocated:

(264)

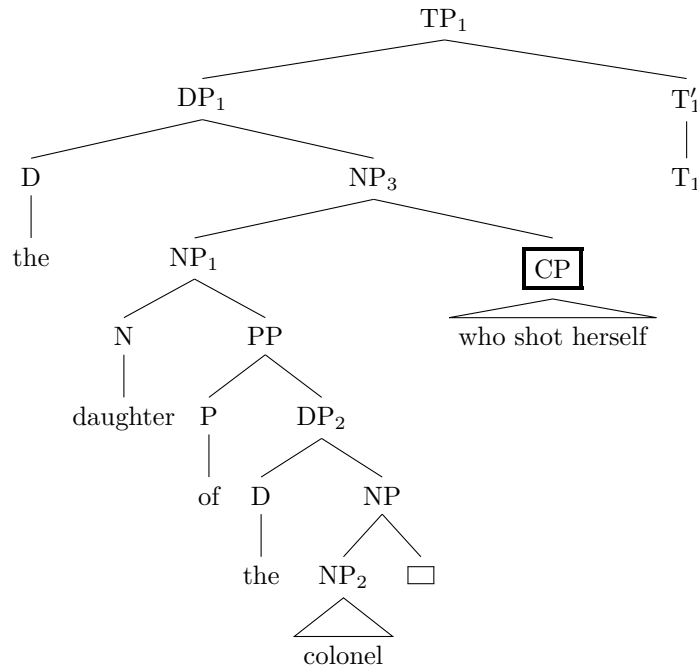

CP's position after reanalysis (marked by a bold box) c-commands its position prior to reanalysis (marked by a box). Therefore, relations such as  $\text{prec}(\text{NP}_2, \text{CP})$ , which has been falsified, is erased according to Unconscious Deletion, and the sentence does not result in a garden path effect, as predicted.

## 8 Discussion

In this section, I would like to discuss some issues that arise from the findings presented in this paper.

### 8.1 The grammar and the parser

The relationship between the grammar and the parser has been a matter of debate in the last decades. Starting in the 1960s, many researchers used to agree that there is a clear distinction between the two. Experimental studies in the 1960s failed to demonstrate that the grammar's operations proposed at the time had a measurable effect on sentence processing. As Phillips (1996) explains, "the received view of the outcome of these studies is that they disconfirmed the view that the operations of the parsing device and transformational grammars were the same".<sup>66</sup> Fodor et al. (1974), among others, claimed that standard models of grammar cannot be implemented as a parser which can successfully recognize sentences in finite time.

Starting in the 1990s, researchers proposed parsers that are driven by grammatical principles. Perhaps the strongest claim has been made by Phillips (1996), namely that "the parser is the grammar". Other researchers have adopted a weaker claim, that devices of the computational system are accessible to the parser. Many of these researchers relied heavily on the garden path phenomenon in their arguments. For instance, Pritchett's (1992) parser, and specifically Theta Attachment discussed in section 3, relies on grammatical principles for resolving local ambiguities (by attempting to maximally satisfy the theta criterion). Pritchett (1992) based his arguments on garden path sentences. Siloni (2004) has also relied on garden path sentences as her empirical array, claiming that the grammar and parser have access to the same computational tools. Mulders (2002) relied on the garden path phenomenon and advocated a parser that "uses only the operations that are available in the grammar".

The findings described here provide further evidence in favor of transparent parsing - that is, that the parser relies on the mechanism employed by the grammar. I assume that the parser constructs a phrase-structure tree, described by structural relations - precedence and dominance. The deletion of relations, described in Unconscious Deletion, relies on another structural relation, c-command. These relevant relations and structural configurations have recourse to basic structural notions that are relevant in production as well.

In recent years, further evidence that the parser is guided by grammatical principles stems from a variety of on-line studies. For example, Stowe (1986,

---

<sup>66</sup>See Wanner (1988) for review of these studies

Experiment 2) and Wagers & Phillips (2009), have demonstrated that the parser avoids building ungrammatical *wh*-dependencies. Since the work of Ross (1967), it is known that *wh*-dependencies are blocked by domains known as “islands”. These studies showed that the parser restricts the search for gap sites from looking into island domains.<sup>67</sup>

Recently, results from on-line experiments specifically suggested that the parser can rely on *c*-command relations for various purposes. For example, Dillon et al. (2013) have demonstrated that when the parser encounters a reflexive pronoun, it does not consider antecedents that violate Principle A (Chomsky (1981)). Similarly, Chow et al. (2014) have demonstrated that readers have immediate sensitivity to Principle B (Chomsky (1981)). Kush et al. (2017) have demonstrated that the parser “can make rapid use of Principle C and *c*-command information to constrain retrieval”. On-line effects of Condition C have been demonstrated in English (Kazanina et al. (2007)), Russian (Kazanina & Phillips (2010)) and Japanese (Aoshima et al. (2009)). Apart from providing support for the hypothesis that the grammar is accessible to the parser, these studies show that the parser relies on *c*-command relations during its operation, a fact that is in line with Unconscious Deletion.

Siloni (2004) points out that the parser and grammar have similar tasks – roughly, associating a structural analysis with a string. Therefore, she claims that the simplest hypothesis is that the same computational system handles both constructing structure and processing. I share this view, and believe that recent psycholinguistic studies mentioned above, as well as the evidence depicted in this paper, support the claim stated by Crocker (2012) as follows: the parser “uses the principle of grammar directly, and processing strategies are defined with respect to the grammar”.

## 8.2 Empty categories and the garden path phenomenon

Much current psycholinguistic investigation addresses the processing of empty categories. This paper provides another interesting insight into the processing of sentences involving empty elements. In section 6.3, we have considered the minimal pair in (194) repeated below:

- (265) a. <sub>OK</sub>∅ kodomo-o koosaten-de mikaketa takusii-ni noseta.  
 ∅ child-ACC intersection-LOC saw taxi-DAT put-on  
 ‘∅ put the child on the taxi (s)he saw at the intersection.’
- b. <sub>GP</sub>Yoko-ga kodomo-o koosaten-de mikaketa takusii-ni  
 Yoko-NOM child-ACC intersection-LOC saw taxi-DAT  
 noseta.  
 put-on  
 ‘Yoko put the child on the taxi she saw at the intersection.’

As can be seen, the only salient difference between the sentences is the appearance of an empty category (*pro*) as the matrix subject of (265a), in contrast

<sup>67</sup>For review, see Phillips et al. (2011)

to the phonetically realized element *Yoko* as the matrix subject of (265b). In section 6.3, I have argued that while the appearance of *Yoko* “blocks” the extraction of *child* to the matrix clause during the processing of (265b), the phonetically-null category in (265a) does not block such extraction. Consequently, (265a) is parsed without a processing breakdown.

Empty categories can indeed “save” a sentence from inducing a garden path effect in other cases as well. Such a case is attested in Spanish, as reported by Jegerski (2012). Consider first the English garden path sentence below:

- (266) <sub>GP</sub>Since Jay always jogs a mile seems like no distance to him.  
 -Jegerski (2012), (1)

(266) consists of a subject/object ambiguity (upon encountering *a mile*), just like (1) presented in section 2. Once the parser has merged *a mile* as the direct object of the verb *jogs*, the continuation in (266) is inconsistent with this analysis and a reanalysis is therefore required, resulting in a garden path effect.

However, the case is different in Spanish. Consider the string in (267) which has two possible readings:

- (267) a. Como José siempre corre una milla le parece poca distancia.  
 Since José always jogs a mile to.him seems little distance  
 ‘Since José always jogs a mile seems like a short distance to him.’  
 b. Como José siempre corre una milla  $\emptyset$  le parece poca distancia.  
 Since José always jogs a mile  $\emptyset$  to.him seems little distance  
 ‘Since José always jogs a mile it seems like a short distance to him.’  
 -Jegerski (2012), (2)

Assuming that the parser operates in Spanish the same way it does in English, when the parser encounters *a mile*, the latter is merged as the direct object of *jogs*. Yet, while in English a reanalysis is required, in Spanish it is not so: The availability of null subjects allows for a parse like that in (267b) without reanalysis. Jegerski (2012) performed a self-paced reading experiment and validated that the string in (267) is indeed easily parsed by native Spanish speakers.

In the above examples, we have seen that empty categories may “save” a sentence from inducing a processing breakdown. This paper further suggests that empty categories cannot be simply removed from the structure during processing, as a garden path effect may occur.

One relevant case is the Chinese example (76) discussed in section 4.2.3. In that case, I argued that the deletion of *PRO* (and consequently falsification of structural relations of dominance of *PRO*) caused the garden path effect. In section 6.3, I have explained the garden path effect invoked by (191), claiming that the relocation of a trace from a subject to an object position has caused the processing breakdown (by falsifying structural relations including that trace).

All together, these examples demonstrate the importance of empty categories in sentence processing, by showing that they can account for a garden path

effect, or the lack thereof.<sup>68</sup>

### 8.3 Is precedence a necessary part of Structural Determinism?

In section 4.2.1 we have reviewed the proposal made in Gorrell (1995), namely *Structural Determinism (SD)* as defined in (62) and repeated below:

- (268) **Structural Determinism (SD)**: The domain of determinism is limited to the primary structural relations, dominance and precedence.  
-Gorrell (1995), Chapter 4, (8)

That is, Gorrell (1995) claims that if any dominance or precedence relation is altered during processing, a garden path effect will be sensed. He explicitly states that “the parser must be computing a structural representation of the input which includes precedence relations” (p. 112). However, in many of the garden path sentences I have reviewed here, at least one dominance relation has been falsified. This raises the question of whether precedence relations are indeed a vital part of Structural Determinism. Gorrell (1995) provides a few examples for sentences that yield a garden path effect, and in which he claims that precedence relations have been altered, but not dominance relations.

Yet, considering the examples discussed in Gorrell (1995) using more updated syntactic structures (e.g., VP-internal Subject and VP-shells), I believe that there is no justification to include the precedence relation in Structural Determinism.<sup>69</sup> In this section I provide a careful examination of the cases discussed in Gorrell (1995), and shortly discuss possible consequences of not explicitly including precedence relation in the description. Note that despite being an interesting question, the relevance of precedence to Structural Determinism is not a crucial part of Unconscious Deletion or Condition on Description Validity, and depends on current syntactic analyses.

#### 8.3.1 Clausal-complementizer/Relative-clause Ambiguity

Gorrell (1995) provides the following example:

- (269) <sub>CP</sub>Ian told the man that he hired to leave.  
-Gorrell (1995), p. 111, (22b)

This resembles the garden path sentence (120) depicted in section 4.3.2 above. Let us consider the structure prior to reanalysis:

---

<sup>68</sup>A discussion of processing empty categories under Structural Determinism can be found in Gorrell (1995) section 4.4.

<sup>69</sup>Marcus et al. (1983) also argued that there is no need to express precedence relations in the structural representation.



(270)

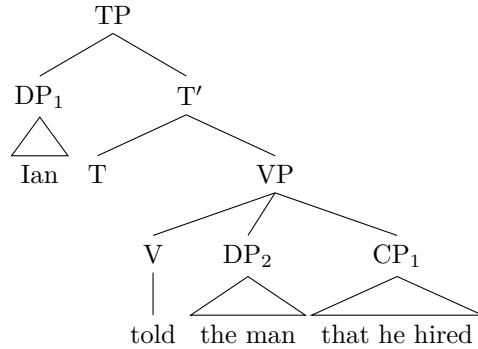

After reanalysis, CP<sub>1</sub> is no longer a complement of the matrix verb, but rather a modifier of *the man*:

(271)

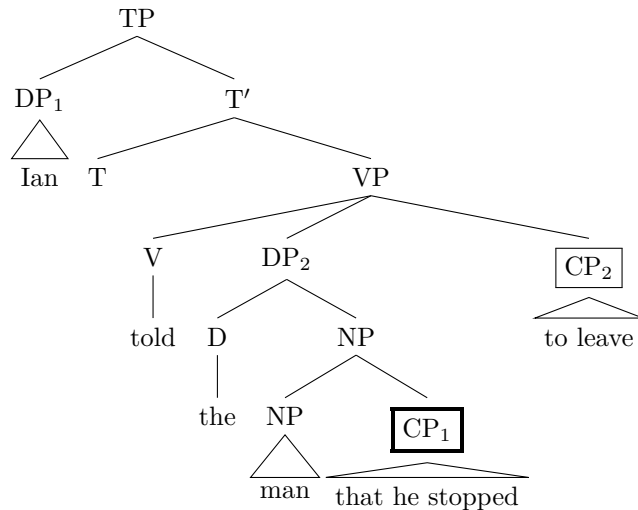

Therefore, the relation  $\text{prec}(\text{DP}_2, \text{CP}_1)$ , that held in (270), no longer holds. This violates Structural Determinism, and is predicted to yield a garden path effect according to the Condition on Description Validity. Moreover, given the structures represented in (270) and (271), it seems that no *dominance* relation has been falsified.

However, considering a VP-shell structure as in Larson (1988) and subsequent work reveals another image. Let us consider the structure that the parser builds prior to reanalysis, assuming a VP-shell structure:

(272)

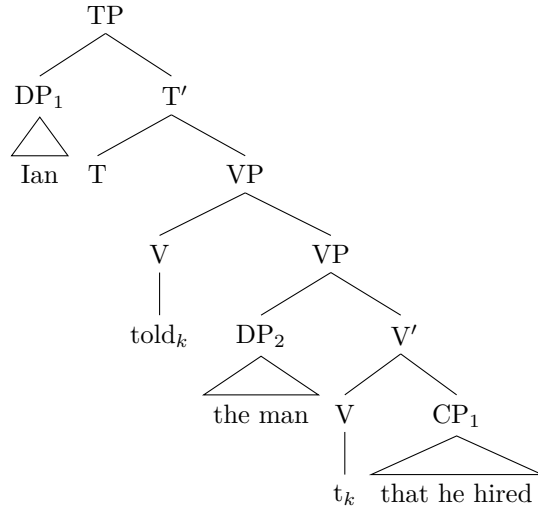

After reanalysis, the VP-shell structure would be:

(273)

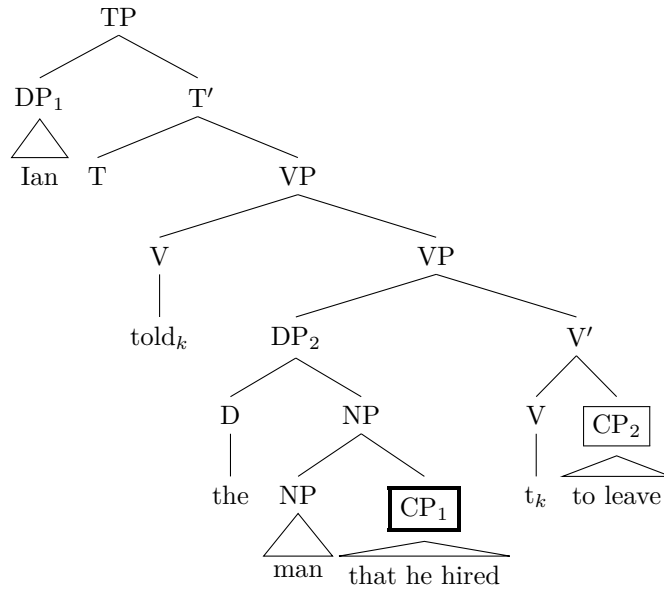

Following the reanalysis, the relation  $\text{dom}(V', CP_1)$ , evident in (272), no longer holds in (273). This relation is not deleted according to Unconscious Deletion. Since this reanalysis includes falsifying a dominance relation, it is unnecessary to rely on precedence in order to account for the garden path effect.

### 8.3.2 Object/Reduced-relative

Now, consider the following sentence:

- (274) <sub>CP</sub>Ian gave the man the report criticized a demotion.  
 -Gorrell (1995), p. 113, (26a)

Let us consider the structure prior to reanalysis:

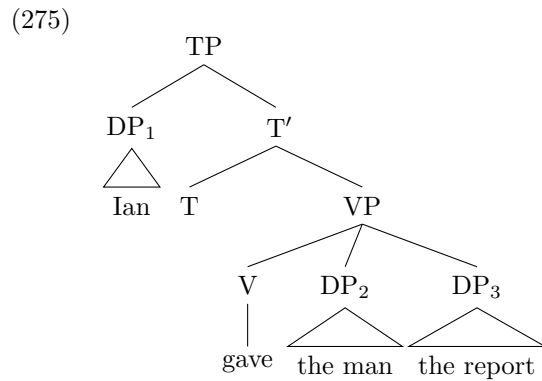

When the parser encounters *criticized*, the above structure is falsified and undergoes a reanalysis, yielding the following structure:

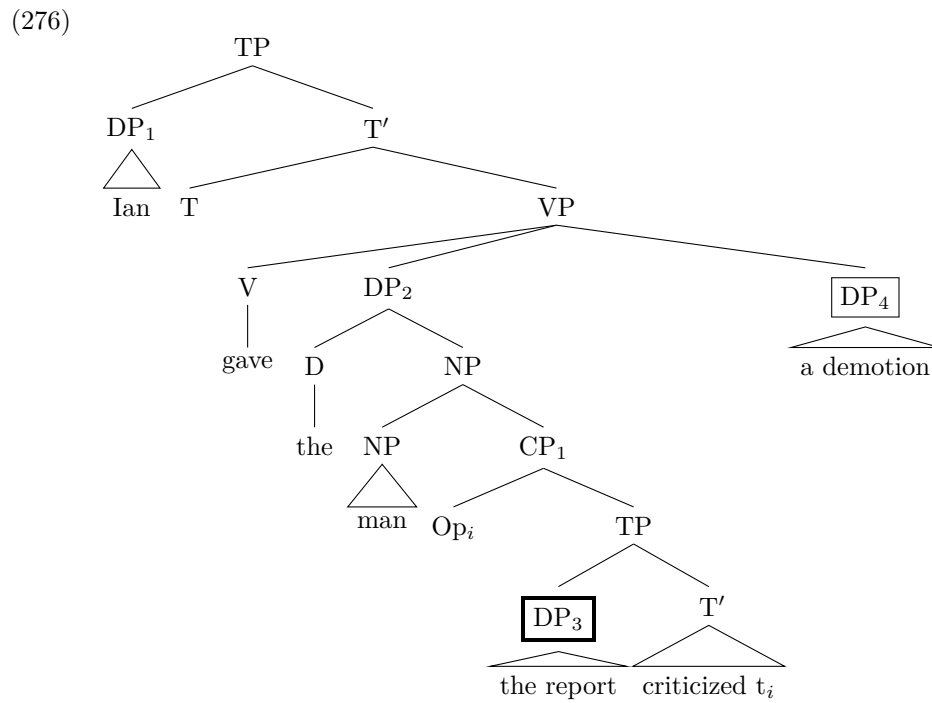

The relation  $\text{prec}(\text{DP}_2, \text{DP}_3)$  that held in (275) has been falsified. However, no dominance relation seems to be violated.

Nevertheless, on a VP-shell structure, as in section 8.3.1, we can see that a dominance relation is indeed falsified.

Assuming a VP-shell, the parser builds the following structure prior to reanalysis:

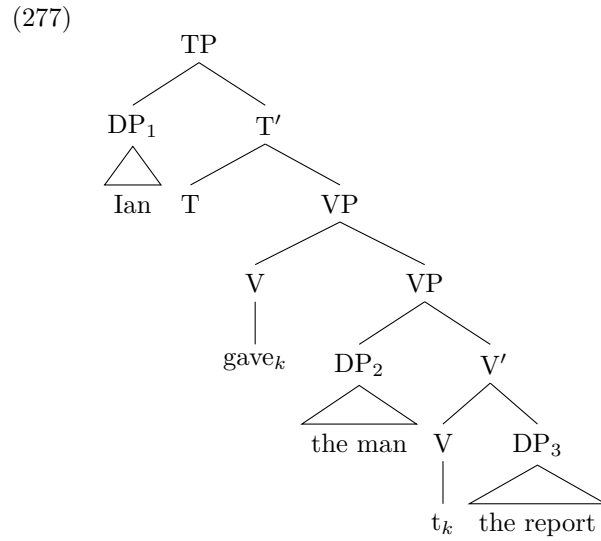

After reanalysis, the following structure is computed:

(278)

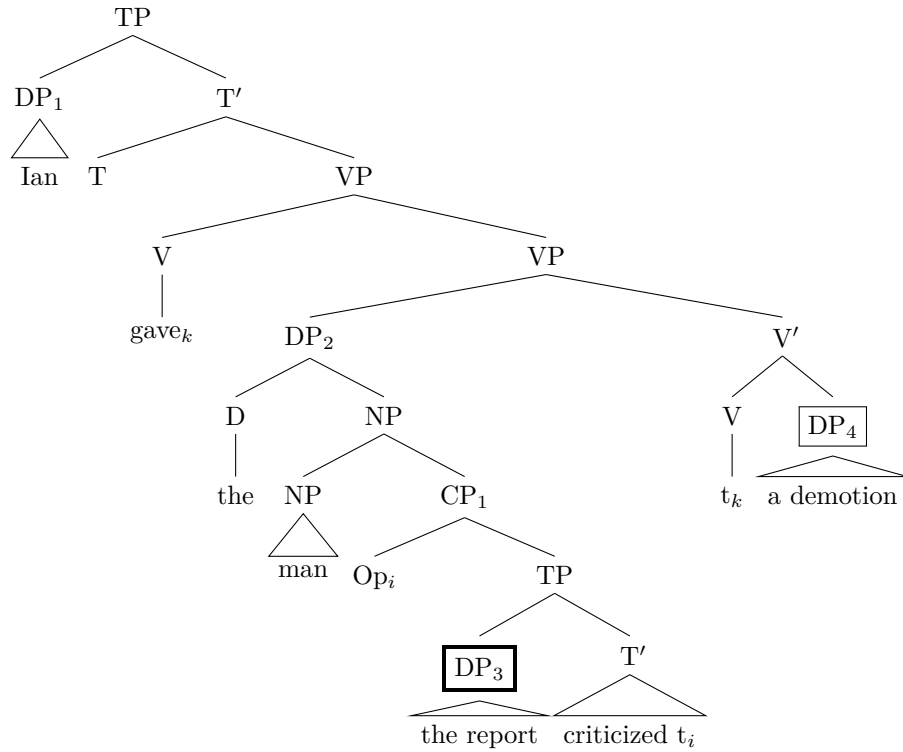

The relation  $\text{dom}(V', DP_3)$  that held prior to reanalysis has been falsified, and is not deleted according to Unconscious Deletion. It is unnecessary to rely on falsifying a precedence relation if we assume a VP-shell.

### 8.3.3 Oblique-comp/NP-modifier

Consider the following sentence:

- (279) <sub>CP</sub>Ian put the candy on the table in his mouth.  
 -Gorrell (1995), p. 115, (30a)

Prior to reanalysis, the structure is as follows:

(280)

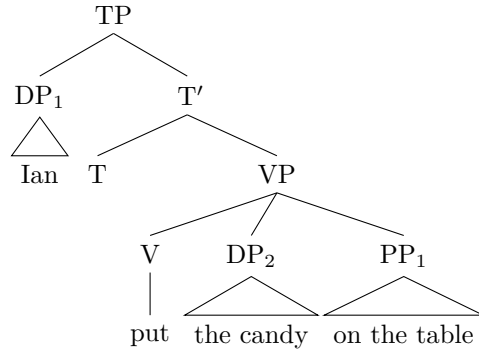

To accomplish reanalysis, the parser would have to compute the structure below:

(281)

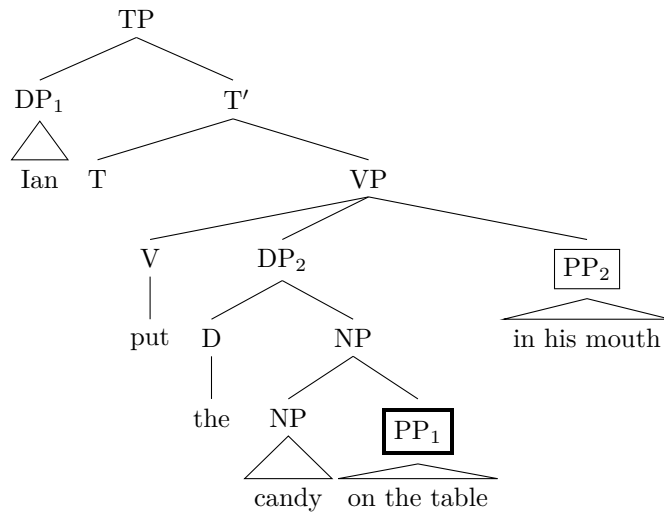

After the reanalysis depicted above, the relation  $\text{prec}(\text{DP}_2, \text{PP}_1)$ , that held prior to reanalysis, is no longer valid. No dominance relations seem to have been falsified given the analysis above.

However, again, on a VP-shell structure a dominance relation has been falsified. Before performing the reanalysis, the parser yields the following structure:

(282)

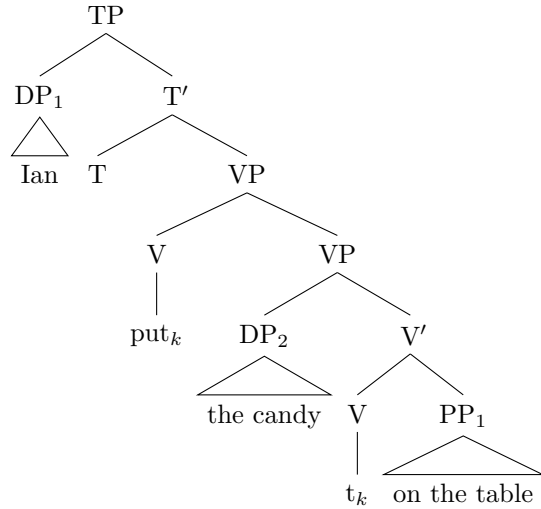

After reanalysis, the following structure would be computed:

(283)

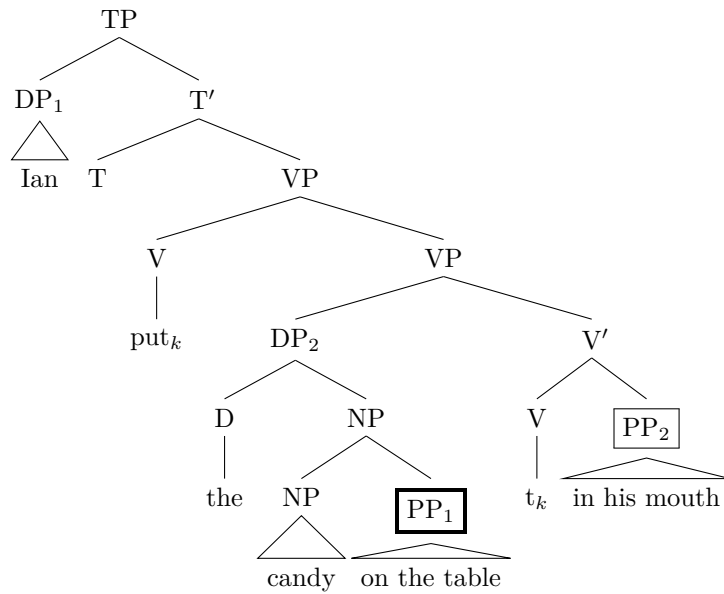

Given the VP-shell analysis, the relation  $\text{dom}(V', PP_1)$  that held in (282) is falsified in (283).

### 8.3.4 Matrix-verb/Reduced-relative

Gorrell (1995) discusses the following sentence, originally from Bever (1970):<sup>70</sup>

<sup>70</sup>(284) is equivalent to (20a) discussed in section 3.2.

- (284)  $_{GP}$ The horse raced past the barn fell.  
 -Gorrell (1995), p. 114, (28a)

Prior to reanalysis, the parser pursues an active reading of the verb *raced*, yielding the following structure:

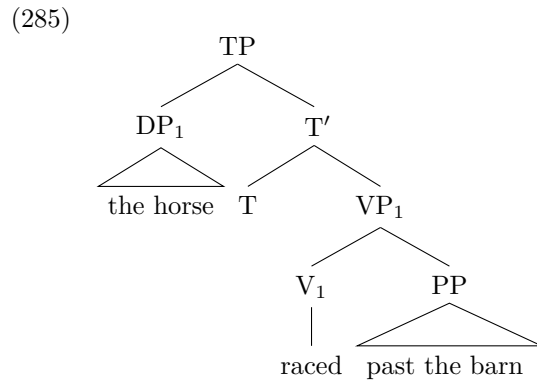

Upon encountering the verb *fell*, a reanalysis is necessary, and the following structure has to be constructed:

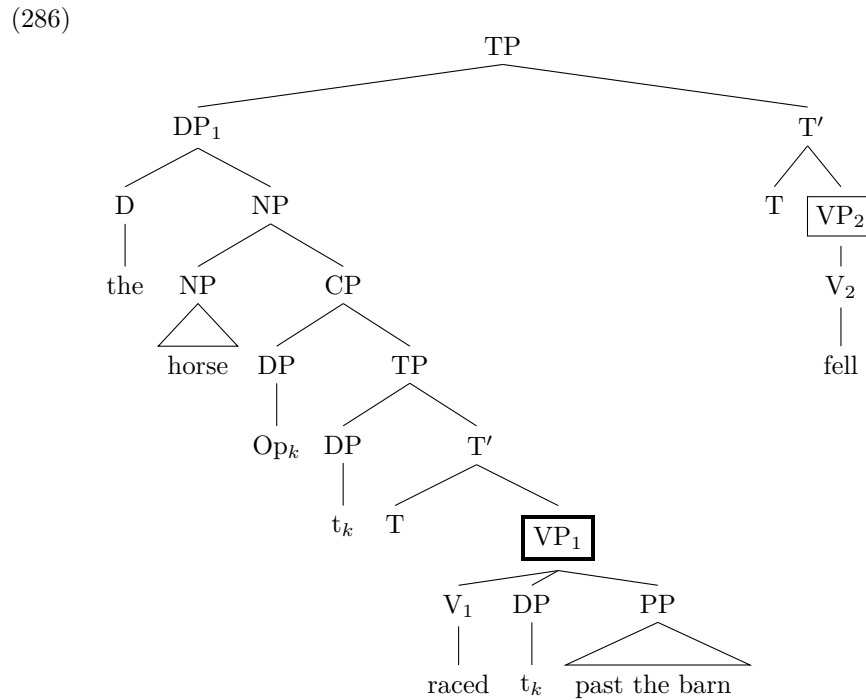

After reanalysis,  $DP_1$  no longer precedes  $VP_1$ , but rather dominates it. Hence, the relation  $prec(DP_1, VP_1)$  that was evident in (285) is invalid following the reanalysis. Yet, as Gorrell (1995) notes in a footnote, assuming



a VP-Internal Subject offers an alternative account for the garden path effect induced by (284). Under such an analysis, the structure prior to reanalysis involves a trace of DP<sub>1</sub> in [Spec VP<sub>1</sub>], as follows:

(287)

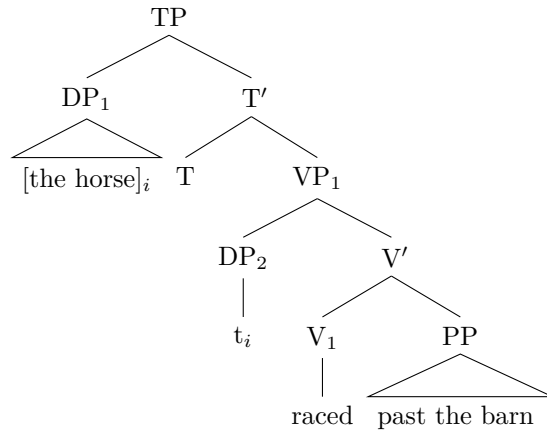

Reanalysing VP<sub>1</sub> to be a part of a CP modifying *the horse* requires the deletion of DP<sub>2</sub> above, and thus also the deletion of the relation dom(VP<sub>1</sub>, DP<sub>2</sub>). That is, the garden path effect is accounted for by falsifying dominance relations only.

### 8.3.5 Possible implications

In section 7.2, we have shown that Unconscious Deletion can account for the easiness of parsing sentences such as in (261), repeated below as (288):

- (288)
- a. The daughter<sub>1</sub> of the colonel<sub>2</sub> who shot herself<sub>1/\*2</sub> on the balcony had been very depressed.
  - b. The daughter<sub>1</sub> of the colonel<sub>2</sub> who shot himself<sub>\*1/2</sub> on the balcony had been very depressed.
  - c. The son<sub>1</sub> of the colonel<sub>2</sub> who shot himself<sub>1/2</sub> on the balcony had been very depressed.

The explanation in section 7.2 relied on the preference for low attachment attested in English. That is, native English speakers first attach the relative clause as a modifier of the *colonel*, and then modify their attachment if necessary.

In languages other than English, the initial attachment preference may be different. For example, Cuetos & Mitchell (1988) have reported that Spanish speakers prefer high attachment in ambiguous cases similar to (288c).<sup>71</sup> Yet, Spanish speakers are not led down the garden path in such examples.

<sup>71</sup>Hemforth et al. (2015) tested attachment preferences in relative clauses in German, English, Spanish, and French. They claim that the between-language differences (e.g., between English and Spanish) are limited in scope, and other factors can account for the data. For example, they found that longer relative clauses favor higher attachment, whereas thematic-

This fact can be accounted for if we do not specify precedence relations in the tree description (and thus falsifying a precedence relation does not result in a garden path effect according to the Condition on Description Validity). Assuming an initial high attachment preference, the parser will compute the following structure upon encountering *who*:

(289)

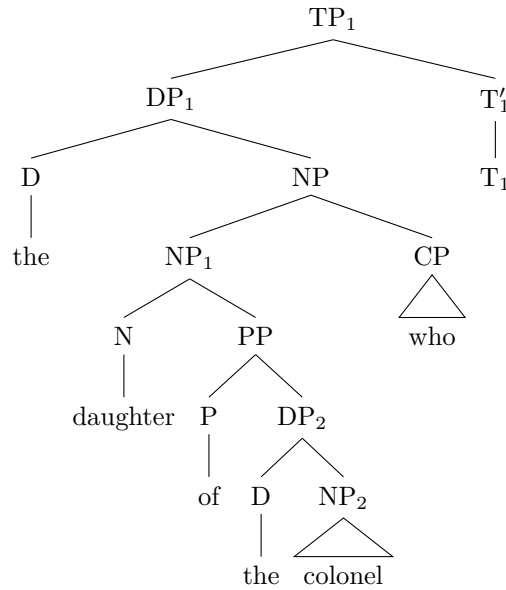

The structure above is compatible with the continuation in (288a), yet not with the one in (288b). In the latter case, a reanalysis would be required, relocating the relative clause as below:

---

role assigning prepositions favor low attachment to their objects. For our concern, it is enough to note that parsers may prefer either high or low attachment, and neither seems to cause a garden path effect. Note that the variance in attachment is compatible with Order of Attachment presented in section 6.1.

(290)

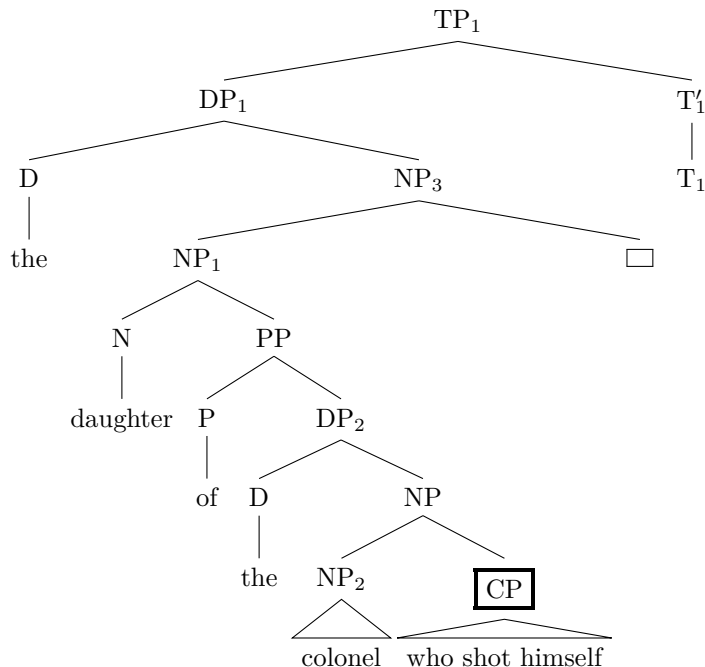

In this case, CP's position after reanalysis (marked by a bold box) does not c-command its position prior to reanalysis (marked by a box). Hence,  $\text{prec}(\text{NP}_1, \text{CP})$  is not erased according to Unconscious Deletion, and it has been falsified. Yet, if the tree description does not include precedence relations, this sentence is not predicted to result in a processing breakdown (as no dominance relations have been falsified).

### 8.3.6 Conclusion

In this section I have closely inspected every case that Gorrell (1995) noted in favor of the need to specify precedence relations in the tree-description. All of these cases can be explained by falsification of *dominance* relations, if we adopt VP-shells and the VP-internal Subject hypothesis.<sup>72</sup>

Therefore, there seems to be no reason to explicitly include precedence relations in the definition of Unconscious Deletion (or Structural Determinism) under these assumptions. Moreover, section 8.3.5 demonstrated a case where *not* specifying a precedence relation allows us to account for additional data.

<sup>72</sup>This holds for other examples described in this paper as well. A VP-shell analysis removes the need for specifying precedence relation in the Korean example (234) depicted in section 6.4.2. In addition, a VP-internal Subject analysis accounts for the garden path effect in (191) described in section 6.3, without relying on precedence relations.

## 9 Summary

In this work, we have investigated the underlying mechanisms of the human sentence processor. For that purpose, we have examined the garden path phenomenon, and provided a comprehensive theory of sentence processing. We started by describing the garden path phenomenon in section 2, and then considered two major questions (originally in (6)):

- (291) a. When facing an ambiguous segment, which analysis does the parser pursue?
- b. When a reanalysis is required, when will it result in a garden path effect?

Section 3, included a review of a suggestion made in Pritchett (1992), namely Theta Attachment, as a possible answer to the question posited in (291a). Later, in section 4, we reviewed three different theories that aim to account for the garden path phenomenon - OLLC, Structural Determinism and reanalysis by movement. We were able to provide counterexamples for each one of these proposals.

Section 5 discussed the incremental nature of the parser. We have concluded that the human parser is not a head-driven licensing parser, and argued for a parser employing Strict Incrementality, as in (131) repeated below:

- (292) **Strict Incrementality:** Each word must be connected to the current tree description at the point at which it is encountered through the addition of a non-empty set of relations to the description.  
-Sturt & Crocker (1996), Chapter 3, (1)

In section 6, I described my own proposal regarding the garden path phenomenon. Section 6.2 summarizes my assumptions regarding what drives structure building by the parser. I claimed that the parser projects positions in advanced, but only *licensed* positions. Positions are either licensed *lexically* or *functionally*, and the parser projects these positions as follows:

- (293) **Licensed Lexical Projection:** When a lexical head is encountered, the parser projects the minimal set of nodes that are required to satisfy the head's lexical requirements.
- (294) **Licensed Functional Projection:** When a functional head is projected, the parser projects its complement.

In general, the parser operates in the following manner:

- (295) **Incremental Projection and Attachment:** at every step, the parser:
  - a. Reads an element from the input.
  - b. Attaches this element to the structure.
  - c. Projects new licensed positions (according to Licensed Lexical Projection and Licensed Functional Projection).

While attaching an element to the structure, the parser works in the following order:

- (296) **Order of Attachment:**
- a. Attach to an empty projected position.
  - b. Attach within a phrasal unit whose lexical head has been read.
  - c. Attach to a new argument position whose head has not yet been projected.

I have also demonstrated that the parser follows the MCP introduced by De Vincenzi (1991, 2000):

- (297) **Minimal Chain Principle (MCP):** Postulate required chain members at the earliest point grammatically possible but postulate no potentially unnecessary chain members.

With all these assumptions, as well as some details described in section 6.1 and omitted from this summary, we have provided a possible answer to question (291a) above.

In section 6.3, I described my suggested answer for question (291b) - namely, what types of reanalysis will result in a garden path effect. Throughout my research, I have not been able to find a sentence that results in a processing breakdown even though Structural Determinism is maintained. This led me to state observation (94), repeated below:

- (298) **Observation:** When Structural Determinism is maintained during reanalysis, the reanalysis does not result in a processing breakdown.

However, I have discussed a few examples where Structural Determinism is violated, and nonetheless a garden path effect is not sensed. Therefore, I concluded that Structural Determinism should be replaced by a less constrained principle:

- (299) **Unconscious Deletion (UD):** A structural relation  $R(\alpha, \beta)$  is deleted iff the position of  $\beta$  after reanalysis c-commands its position prior to reanalysis.

In addition, I stated when a garden path effect would be sensed:

- (300) **Condition on Description Validity (CDV):** A garden path effect is sensed iff a relation in the tree description is invalid.

Assuming Unconscious Deletion and the Condition on Description Validity, it is possible to account for the data regarding a large variety of sentences discussed in this paper, including the ones who proved to be problematic for the three reviewed proposals (OLLC, Structural Determinism and reanalysis by movement).

In section 6.4, I considered various sentences in light of the proposal suggested here in order to examine its validity. I have specifically considered

Japanese sentences where a reanalysis is invoked by a theta-assigner, and Korean sentences which include scrambling. Section 6.5 discussed the consequences of the current proposal for processing phenomena other than garden path - specifically, processing ambiguous pronouns in German. Section 6.6 describes further predictions of the current proposal that should still be tested.

Section 7 discussed the application of Unconscious Deletion in head-initial languages. In section 8 I discussed some issues that arise from the findings presented in this paper. Specifically, I claimed that the current findings suggest that the same structural notions are relevant in both production and processing.

## 10 Appendix - Sentence Types

This appendix lists sentences that yield a garden path effect, as well as sentences that are very similar to garden path sentences, but that do not cause a processing breakdown. This resource should allow a researcher to both validate existing suggestions in the literature (considering the different sentences and the predictions that the proposal in question yields), as well as validate his or her own assumptions when suggesting a new theory. I extend the tables provided in Lewis (1992), Appendix A.

Table 1: GP Sentences

| Type                                                         | Source                       | Example                                                                                                                                                                                                        |
|--------------------------------------------------------------|------------------------------|----------------------------------------------------------------------------------------------------------------------------------------------------------------------------------------------------------------|
| Matrix-verb /<br>Reduced-relative                            | Bever (1970)                 | The boat floated down the river sank.<br>(cf. The boat that was floated down the river sank.)                                                                                                                  |
| NP-modifier /<br>NP                                          | Marcus (1980)                | The Russian women loved died.<br>(cf. The Russian that women loved died.)                                                                                                                                      |
| Object /<br>Reduced-relative                                 | Pritchett (1988)             | John gave the boy the dog bit a dollar.<br>(cf. John gave a dollar to the boy that the dog bit.)                                                                                                               |
| Oblique-comp /<br>NP-modifier                                | Gibson (1990a)               | I put the candy on the table in my mouth.<br>(cf. I put the candy that was on the table into my mouth.)                                                                                                        |
| Embedded-<br>object / Object                                 | Pritchett (1988)             | Sue gave the man who was reading the book.<br>(cf. Sue gave the book to the man who was reading.)                                                                                                              |
| Verb / Noun                                                  | Milne (1982)                 | The building blocks the sun faded are red.<br>(cf. The building blocks that the sun faded are red.)                                                                                                            |
| Clausal-<br>complementizer<br>/ Relative-clause<br>Ambiguity | Crain & Steed-<br>man (1985) | John told the man that Mary kissed that Bill saw Phil.<br>(cf. The man that Mary kissed was told by John that Bill saw Phil.)                                                                                  |
| Object/Subject<br>Ambiguity                                  | Frazier & Rayner<br>(1982)   | While Mary was mending the clock started to chime.<br>(cf. While Mary was mending, the clock started to chime.)                                                                                                |
| Predicate-comp<br>/ Noun                                     | Pritchett (1988)             | The boy got fat melted.<br>(cf. The boy got some fat melted for the cook.)                                                                                                                                     |
| Object / Subject<br>w/relative                               | Warner & Glass<br>(1987)     | Before the boy kills the man the dog bites strikes.<br>(cf. Before the boy kills, the man that the dog bites strikes.)                                                                                         |
| Tense ambiguity                                              | Warner & Glass<br>(1987)     | The boys put out the dogs that are strong when the man who is very<br>ugly strikes the clock.<br>(cf. The boys put out the dogs when the man struck the clock.)                                                |
| Clausal-object<br>ambiguity                                  | Warner & Glass<br>(1987)     | The girls believe the man who believes the very strong ugly boys<br>struck the dog killed the cats.<br>(cf. The man who believes the boys struck the dog is believed by the<br>girls to have killed the cats.) |
| Complementizer<br>/ Pronoun                                  | Lewis (1992)                 | Before she knew that she went to the store.<br>(cf. Before she knew that, she went to the store.)                                                                                                              |
| Matrix-verb /<br>Relative (short)                            | Pritchett (1988)             | The boat floated sank.<br>(cf. The boat that was floated sank.)                                                                                                                                                |

|                                                                                  |                         |                                                                                                                                                                                                                                          |
|----------------------------------------------------------------------------------|-------------------------|------------------------------------------------------------------------------------------------------------------------------------------------------------------------------------------------------------------------------------------|
| Throughout ambiguity                                                             | Allen (1987)            | Throughout the plan structure that serves as the expectation will be called the e-plan.<br>(cf. Throughout, the plan structure that serves as the expectation will be called the e-plan.)                                                |
| Direct-object / Clausal-subject as second complement                             | Pritchett (1988)        | John warned the man cheated.<br>(cf. John warned that the man cheated.)                                                                                                                                                                  |
| Adjective / Noun Ambiguity                                                       | Just & Carpenter (1987) | The old train the young.<br>(cf. The old people train the young people.)                                                                                                                                                                 |
| NP/Possessor Ambiguity                                                           | Pritchett (1992)        | Without her contributions failed to come in.<br>(cf. Without her the contributions failed to come in.)                                                                                                                                   |
| Noun-Noun / Relative clause                                                      | Marcus (1980)           | The cotton clothing is made of grows in Mississippi.<br>(cf. The cotton with clothing is made of grows in Mississippi.)                                                                                                                  |
| Hebrew Noun / Passive verb                                                       | Siloni (2004)           | xulca metayelet b-a-vadi.<br>shirt travels in-the-wadi<br><br>'A shirt travels the wadi.' (cf.<br><br>xulca metayelet b-a-vadi.<br>was.rescued hiker[Fem] in-the-wadi<br><br>'A (female) hiker was rescued in the wadi.')                |
| Hebrew Noun / Verb heterophonic homograph                                        | Current paper, (23)     | bi-zman še-ra'iti yeled ŠOVR higi'a b-a-do'ar.<br>in-time that-I.saw boy coupon/breaking arrived in-the-mail<br><br>'When I saw a boy, a coupon arrived in the mail.'                                                                    |
| Japanese relative with overt subject and object, canonical order                 | Mazuka & Itoh (1995)    | Yoko-ga kodomo-o koosaten-de mikaketa takusii-ni<br>Yoko-NOM child-ACC intersection-LOC saw taxi-DAT<br>noseta.<br>put-on<br><br>'Yoko put the child on the taxi she saw at the intersection.'                                           |
| Japanese relative with overt subject and object, canonical order, theta-assigner | Mazuka & Itoh (1995)    | Huruhasi-ga Yumiko-o yobidasita kissaten-ni nagai koto<br>Huruhasi-NOM Yumiko-ACC summoned tearoom-LOC long time<br>mata-seta.<br>wait-made<br><br>'Huruhasi made Yumiko wait for a long time at the tea room to which he summoned her.' |



|                                                         |                      |                                                                                                                                                                                                                                                                                                                                                                |
|---------------------------------------------------------|----------------------|----------------------------------------------------------------------------------------------------------------------------------------------------------------------------------------------------------------------------------------------------------------------------------------------------------------------------------------------------------------|
| Japanese locative                                       | Mazuka & Itoh (1995) | Yamasita-ga yuuzin-o hoomonsita kaisya-de mikaketa<br>Yamasita-NOM friend-ACC visited company-LOC saw<br><br>'Yamasita saw his friend at the company he visited.'                                                                                                                                                                                              |
| Chinese Object of PP-adjunct / Subject of matrix clause | Lee (2006)           | Weile huanbao yundong bixu shenhua<br>for environment-protection campaign must deepen<br><br>'For the sake of the environmental protection, the campaign must deepen.'                                                                                                                                                                                         |
| Chinese Complement-clause / Relative-clause             | Lee (2006)           | Wang jingli xihuan he Faguo putaojiu de guyuan<br>Wang manager like drink French wine NOM employee<br><br>'Manager Wang likes employees that drink French wine.'                                                                                                                                                                                               |
| Chinese Subject / Object                                | Lee (2006)           | Zhe jibaige gongren, jingli jueding jieping gongsi<br>This several-hundred worker, manager decide fire company<br>gupiao jiu dadie le<br>stocks then fall asp<br><br>'As for these several hundred workers, (once) the manager decided to fire (them), the company stocks fell (in prices).'                                                                   |
| Chinese Verb-particle / Verb lexical ambiguity          | Lee (2006)           | Zhe jige nianqingren ai shang mingxing de<br>This few young people love RESULT/experience movie-star<br>dang<br>NOM trick<br><br>'These several young people loved to experience movie stars' tricks.'                                                                                                                                                         |
| Chinese Verb-particle / Adjective lexical ambiguity     | Lee (2006)           | Zhubanren xiangjin banfa zuzhi hao ban de<br>Sponsor think-all ways organize RESULT/good class NOM<br>tongxue, zhoumo wanhui zhiliang cai you baozheng<br>student, weekend party quality then have guarantee<br><br>'Only if the sponsors thought of all ways to organize the students of the good class will the quality of the weekend party be guaranteed.' |

|                                                    |                        |                                                                                                                                                                                                                                                           |
|----------------------------------------------------|------------------------|-----------------------------------------------------------------------------------------------------------------------------------------------------------------------------------------------------------------------------------------------------------|
| Chinese Locative particle / Verb lexical ambiguity | Lee (2006)             | <p>Women zai bieshu xia mian xiang haiyang<br/> We at villa under face toward ocean</p> <p>'We, below the villa, face toward the ocean.'</p>                                                                                                              |
| Korean Scrambled / Base-generated subject          | Suh (2005)             | <p>Kiho-nun Mina-eykey Yumi-ka ecey sokayhayssta<br/> Kiho-TOP Mina-DAT Yumi-NOM yesterday introduced</p> <p>'As for Kiho, Yumi introduced him to Mina yesterday.'</p>                                                                                    |
| Korean Modifier / Object                           | Hwang & Schafer (2009) | <p>Phigules-i Lopin-eykey Phwuwu-ka ttacwu-n pelcip-ul<br/> Piglet-NOM Robin-DAT Pooh-NOM pick-REL honeycomb-ACC<br/> Thige-eykey phalapelyessta<br/> Tigger-DAT sold</p> <p>'Piglet sold Tigger [the honeycomb [that Pooh picked for Robin]].'</p>       |
| German sie ambiguity active / passive              | Bader & Lasser (1994)  | <p>daß sie nach dem Ergebnis zu fragen tatsächlich erlaubt<br/> that she/her for the result to ask indeed permitted<br/> worden ist<br/> has been</p> <p>'that to ask her for the result has been permitted'</p>                                          |
| German Theta-assigner noun                         | Crocker (1990)         | <p>... dass der Entdecker von Amerika erst im 18. Jahrhundert<br/> ... that the discoverer of America first in 18th century<br/> erfahren hat.<br/> learned-of has</p> <p>'...that the discoverer learned of America originally in the 18th century.'</p> |
|                                                    |                        |                                                                                                                                                                                                                                                           |

Table 2: Non-GP Sentences

| Type                                             | Source                                            | Example                                                                                                              |
|--------------------------------------------------|---------------------------------------------------|----------------------------------------------------------------------------------------------------------------------|
| Matrix-verb /<br>Reduced-relative                | Ferreira &<br>Clifton (1986),<br>Pritchett (1992) | The defendant examined the evidence.<br>The defendant examined by the lawyer shocked the jury.                       |
| Clausal-modifier<br>/ Noun-modifier              | Taraban & Mc-<br>Clelland (1988)                  | The spy saw the cop with the binoculars.<br>The spy saw the cop with the revolver.                                   |
| Direct-object /<br>Clausal-subject               | Pritchett (1988)                                  | I knew the man.<br>I knew the man hated me passionately.                                                             |
| Plural / Posses-<br>sive                         | Pritchett (1988)                                  | The woman kicked her sons.<br>The woman kicked her sons' dogs' houses' doors.                                        |
| Noun-modifier /<br>Noun                          | Pritchett (1988)                                  | Without her we failed.<br>Without her contributions we failed.                                                       |
| Theta-role<br>switch                             | Pritchett (1988),<br>Gibson (1990b)               | They gave her books.<br>They gave her books to Ron.                                                                  |
| Verb / Noun                                      | Milne (1982),<br>Pritchett (1992)                 | The building blocks are red.<br>The building blocks the sun.                                                         |
| Object / Subject                                 | Warner & Glass<br>(1987)                          | When the boys strike the dog kills.<br>When the boys strike the dog the cat runs away.                               |
| Have-question /<br>imperative                    | Marcus (1980)                                     | Have the boys taken the exam today?.<br>Have the boys take the exam today.                                           |
| Adjective sense<br>ambiguity                     | Lewis (1992)                                      | The deep pit was scary.<br>The deep philosopher was kind.                                                            |
| Question-<br>predicate /<br>NP-modifier          | Marcus (1980)                                     | Is the block in the box?<br>Is the block in the box red?                                                             |
| Coordinate am-<br>biguity                        | Lewis (1992)                                      | I went to the mall and the drugstore.<br>I went to the mall and the drugstore was closed.                            |
| Direct-object /<br>Clausal-object<br>(long)      | Warner & Glass<br>(1987)                          | The girls believe the man who struck the dog.<br>The girls believe the man who struck the dog killed the cats.       |
| Matrix-verb /<br>Reduced-relative                | Lewis (1992)                                      | The defendant carefully examined the evidence.<br>The defendant carefully examined by the prosecutor looked nervous. |
| Predicate-comp<br>/ Describer                    | Lewis (1992)                                      | The boy got fat.<br>The boy got fat mice for his pet snake.                                                          |
| Object / prep-<br>object-gap                     | Lewis (1992)                                      | John saw the ball the boy hit.<br>John saw the ball the boy hit the window with.                                     |
| Singular / plural<br>noun                        | Lewis (1992)                                      | The sheep seem very happy.<br>The sheep seems very happy.                                                            |
| Verb / Verb+<br>particle                         | Lewis (1992)                                      | John picked the boy for this team.<br>John picked the boy up yesterday.                                              |
| Reduced rel-<br>atives with a<br>transitive verb | Pritchett (1992)                                  | The spaceship destroyed in the battle disintegrated.                                                                 |

|                                                                  |                      |                                                                                                                                                                                                                                                                                                                                                                                                                                                                                                                                   |
|------------------------------------------------------------------|----------------------|-----------------------------------------------------------------------------------------------------------------------------------------------------------------------------------------------------------------------------------------------------------------------------------------------------------------------------------------------------------------------------------------------------------------------------------------------------------------------------------------------------------------------------------|
| Hebrew Noun / Verb heterophonic homograph                        | Current paper, (25)  | <p>okbi-zman še-ra'iti yeled ŠOVR xalon mixtav<br/> in-time that-I.saw boy coupon/breaking window letter<br/> higi'a b-a-do'ar.<br/> arrived in-the-mail</p> <p>'When I saw a boy breaking a window, a coupon arrived in the mail.'</p>                                                                                                                                                                                                                                                                                           |
| Japanese yatta-kureta                                            | Mazuka & Itoh (1995) | <p>Nakamura-ga tyuuko-no pasokon-o katta toki<br/> Nakamura-NOM second-hand PC-ACC bought when<br/> syuuri-site-kureta.<br/> repaired(for-me)</p> <p>'Nakamura<sub>i</sub>, when (I<sub>j</sub>) bought a second-hand PC, repaired (it) for me<sub>j</sub>.'</p> <p>Nakamura-ga tyuuko-no pasokon-o katta toki<br/> Nakamura-NOM second-hand PC-ACC bought when<br/> syuuri-site-yatta.<br/> repaired(for-him)</p> <p>'When Nakamura<sub>i</sub> bought a second-hand PC, (I<sub>j</sub>) repaired (it) for him<sub>i</sub>.'</p> |
| Japanese object with subject relative                            | Mazuka & Itoh (1995) | <p>Yamasita-ga yuuzin-o hoomonsita siriai-ni<br/> Yamasita-NOM friend-ACC visited acquaintance-DAT<br/> tegami-o kaita<br/> letter-ACC wrote</p> <p>'Yamasita wrote a letter to an acquaintance who visited his friend.'</p>                                                                                                                                                                                                                                                                                                      |
| Japanese relative with covert subject                            | Mazuka & Itoh (1995) | <p>∅ kodomo-o koosaten-de mikaketa takusii-ni noseta.<br/> ∅ child-ACC intersection-LOC saw taxi-DAT put-on</p> <p>'∅ put the child on the taxi (s)he saw at the intersection.'</p>                                                                                                                                                                                                                                                                                                                                               |
| Japanese relative with overt subject and object, scrambled order | Mazuka & Itoh (1995) | <p>kodomo-o Yoko-ga koosaten-de mikaketa takusii-ni<br/> child-ACC Yoko-NOM intersection-LOC saw taxi-DAT<br/> noseta.<br/> put-on</p> <p>'Yoko put the child on the taxi she saw at the intersection.'</p>                                                                                                                                                                                                                                                                                                                       |

|                                                                                  |                      |                                                                                                                                                                                                                                          |
|----------------------------------------------------------------------------------|----------------------|------------------------------------------------------------------------------------------------------------------------------------------------------------------------------------------------------------------------------------------|
| Japanese relative with overt subject and object, scrambled order, theta-assigner | Mazuka & Itoh (1995) | Yumiko-o Huruhasi-ga yobidasita kissaten-ni nagai koto<br>Yumiko-ACC Huruhasi-NOM summoned tearoom-LOC long time<br>mata-seta.<br>wait-made<br><br>'Huruhasi made Yumiko wait for a long time at the tea room to which he summoned her.' |
| Japanese relative with covert subject, theta-assigner                            | Mazuka & Itoh (1995) | ∅ Yumiko-o yobidasita kissaten-ni nagai koto mata-seta.<br>∅ Yumiko-ACC summoned tearoom-LOC long time wait-made<br><br>'∅ made Yumiko wait for a long time at the tea room to which he summoned her.'                                   |
| Japanese relative with overt subject and object, modifying animate NP            | Mazuka & Itoh (1995) | Yoko-ga kodomo-o koosaten-de mikaketa uma-ni<br>Yoko-NOM child-ACC intersection-LOC saw horse-DAT<br>noseta.<br>put-on<br><br>'Yoko put him/her on the horse that saw the child at the intersection.'                                    |
| Japanese subject relative                                                        | Mazuka & Itoh (1995) | Yoko-ga kodomo-o koosaten-de mikaketa onnanoko-ni<br>Yoko-NOM child-ACC intersection-LOC saw girl-DAT<br>koe-o-kaketa.<br>called<br><br>'Yoko called the girl who saw the child at the intersection.'                                    |
| Chinese Object of PP-adjunct / Subject of matrix clause                          | Lee (2006)           | Weile huanbao yundong bixu choukuan<br>for environment-protection campaign must fund-raise<br><br>'For the sake of the environmental protection campaign, (we) must fundraise.'                                                          |
| Chinese Complement-clause / Relative-clause                                      | Lee (2006)           | Wang jingli xihuan he Faguo putaojiu de weidao<br>Wang manager like drink French wine NOM taste<br><br>'Manager Wang likes to drink (for) the French wine's taste.'                                                                      |

|                                                     |                        |                                                                                                                                                                                                                                                                                                                                                   |
|-----------------------------------------------------|------------------------|---------------------------------------------------------------------------------------------------------------------------------------------------------------------------------------------------------------------------------------------------------------------------------------------------------------------------------------------------|
| Chinese Subject / Object                            | Lee (2006)             | <p>Zhe jibaige gongren, jingli jueding jieping wushiming<br/> This several-hundred worker, manager decide fire fifty<br/> gongsi gupiao jiu dadie le<br/> company stocks then fall asp</p> <p>'As for these several hundred workers, (once) the manager decided to fire fifty (of them), the company stocks fell (in prices).'</p>                |
| Chinese Verb-particle / Verb lexical ambiguity      | Lee (2006)             | <p>Zhe jige nianqingren ai shang mingxing de<br/> This few young people love RESULT/experience movie-star<br/> rongmao<br/> NOM appearance</p> <p>'These several young people fell in love with the movie stars' looks.'</p>                                                                                                                      |
| Chinese Verb-particle / Adjective lexical ambiguity | Lee (2006)             | <p>Zhubanren xiangjin banfa zuzhi hao gao nianji<br/> Sponsor think-all ways organize-RESULT upper year NOM<br/> de tongxue, wanhui zhiliang cai you baozheng<br/> student, party quality then have guarantee.</p> <p>'Only if the sponsors thought of all ways to organize upper year students will the quality of the party be guaranteed.'</p> |
| Chinese Locative particle / Verb lexical ambiguity  | Lee (2006)             | <p>Women zai bieshu xia-mian bu pangxie<br/> We at villa below catch crab</p> <p>'We fish for crabs below the villa.'</p>                                                                                                                                                                                                                         |
| Korean Scrambled / Base-generated subject           | Suh (2005)             | <p>Kiho-nun Mina-eykey Yumi-ka ecey swuswul-ul<br/> Kiho-TOP Mina-DAT Yumi-NOM yesterday operation-ACC<br/> hayssta-ko malhayssta<br/> did-COMP said</p> <p>'Kiho told Mina that Yumi underwent an operation yesterday.'</p>                                                                                                                      |
| Korean Modifier / Object                            | Hwang & Schafer (2009) | <p>Phigules-i Lopin-eykey Phwuwu-ka ttacwu-n pelcip-ul<br/> Piglet-NOM Robin-DAT Pooh-NOM pick-REL honeycomb-ACC<br/> unkunsulccek phalapelyessta<br/> stealthily sold</p> <p>'Piglet stealthily sold [the honeycomb [that Pooh picked]] to Robin.'</p>                                                                                           |

|                                       |                       |                                                                                                                                                                                                                                                                                                                                                                                                                                                                  |
|---------------------------------------|-----------------------|------------------------------------------------------------------------------------------------------------------------------------------------------------------------------------------------------------------------------------------------------------------------------------------------------------------------------------------------------------------------------------------------------------------------------------------------------------------|
| German sie ambiguity active / passive | Bader & Lasser (1994) | <p>daß sie nach dem Ergebnis zu fragen tatsächlich erlaubt<br/> that she/her for the result to ask indeed permitted<br/> hat<br/> has</p> <p>'that she indeed has permitted to ask for the result'</p>                                                                                                                                                                                                                                                           |
| German sie subject / object ambiguity | Bader & Meng (1999)   | <p>Die Direktorin hat erzählt, daß sie einige der Kollegen<br/> The director has said, that she some the colleagues<br/> angerufen hat.<br/> phoned has</p> <p>'The director said that she phoned some of the colleagues.'</p> <p>Die Direktorin hat erzählt, daß sie einige der Kollegen<br/> The director has said, that she some the colleagues<br/> angerufen haben.<br/> phoned have</p> <p>'The director said that some of the colleagues phoned her.'</p> |
| Dutch PP ambiguity                    | Frazier (1987)        | <p>... dat het meisje van Holland houdt.<br/> ... that the girl from Holland likes</p> <p>'...that the girl likes Holland.'</p> <p>... dat bet meisje van Holland glimlachte.<br/> ... that the girl from Holland smiled</p> <p>'...that the girl from Holland smiled.'</p>                                                                                                                                                                                      |
| Spanish Subject / Object with pro     | Jegerski (2012)       | <p>Como José siempre corre una milla <math>\emptyset</math> le parece poca distancia.<br/> Since José always jogs a mile to.him <math>\emptyset</math> seems little distance</p> <p>'Since José always jogs a mile (it) seems like a short distance to him.'</p>                                                                                                                                                                                                 |

## References

- [1] Abney, S. (1987). Licensing and parsing. In Proceedings of NELS (Vol. 17, No. 1, p. 1). Amherst, MA: University of Massachusetts.
- [2] Abney, S. P. (1989). A computational model of human parsing. *Journal of psycholinguistic Research*, 18(1), 129-144.
- [3] Allen, J. F. (1987). *Natural language understanding*. Benjamin/Cummings series in computer science.
- [4] Altmann, G. (1988). Ambiguity, parsing strategies, and computational models. *Language and Cognitive Processes*, 3(2), 73-97.
- [5] Aoshima, S., Phillips, C., & Weinberg, A. (2004). Processing filler-gap dependencies in a head-final language. *Journal of memory and language*, 51(1), 23-54.
- [6] Aoshima, S., Yoshida, M., & Phillips, C. (2009). Incremental processing of coreference and binding in Japanese. *Syntax*, 12(2), 93-134.
- [7] Bader, M., & Lasser, I. (1994). 10 German Verb-Final Clauses and Sentence Processing: Evidence for Immediate Attachment. *Perspectives on sentence processing*.
- [8] Bader, M., & Meng, M. (1999). Subject-object ambiguities in German embedded clauses: An across-the-board comparison. *Journal of Psycholinguistic Research*, 28(2), 121-143.
- [9] Barton Jr, G. E., & Berwick, R. C. (1985). Parsing with Assertion Sets and Information Monotonicity. In *IJCAI* (pp. 769-771).
- [10] Carreiras, M., & Clifton, C. (1999). Another word on parsing relative clauses: Eyetracking evidence from Spanish and English. *Memory & cognition*, 27(5), 826-833.
- [11] Chomsky, N. (1981). *Lectures on Government and Binding*. Dordrecht: Foris Publications.
- [12] Chomsky, N. (1986a). *Barriers* (Vol. 13). MIT press.
- [13] Chomsky, N. (1986b). *Knowledge of language: Its nature, origin, and use*. Greenwood Publishing Group.
- [14] Chomsky, N. (1995). *The minimalist program*. MIT press.
- [15] Chow, W. Y., Lewis, S., & Phillips, C. (2014). Immediate sensitivity to structural constraints in pronoun resolution. *Frontiers in Psychology*, 5, 630.



- [16] Crain, S., & Steedman, M. (1985). On not being led up the garden path: The use of context by the psychological parser. *Natural language parsing*, 320-358.
- [17] Crocker, M. W. (1990). Principle-based sentence processing: A cross-linguistic account. HCRC Publications, University of Edinburgh.
- [18] Crocker, M. W. (1999). Mechanisms for sentence processing. *Language processing*, 191-232.
- [19] Crocker, M. W. (2012). Computational psycholinguistics: An interdisciplinary approach to the study of language (Vol. 20). Springer Science & Business Media.
- [20] Cuetos, F., & Mitchell, D. C. (1988). Cross-linguistic differences in parsing: Restrictions on the use of the Late Closure strategy in Spanish. *Cognition*, 30(1), 73-105.
- [21] De Vincenzi, M. (1991). Filler-gap dependencies in a null subject language: Referential and nonreferential WHs. *Journal of Psycholinguistic Research*, 20(3), 197-213.
- [22] De Vincenzi, M., & Job, R. (1995). An investigation of late closure: The role of syntax, thematic structure, and pragmatics in initial interpretation. *Journal of Experimental Psychology: Learning, Memory, and Cognition*, 21(5), 1303.
- [23] De Vincenzi, M. (2000). Cross-linguistic psycholinguistics. *Architectures and mechanisms for language processing*, 282-300.
- [24] Dillon, B., Mishler, A., Sloggett, S., & Phillips, C. (2013). Contrasting intrusion profiles for agreement and anaphora: Experimental and modeling evidence. *Journal of Memory and Language*, 69(2), 85-103.
- [25] Eshghi, A., Purver, M., & Hough, J. (2013). Dylan: Parser for dynamic syntax.
- [26] Ferreira, F., & Clifton, C. (1986). The independence of syntactic processing. *Journal of memory and language*, 25(3), 348-368.
- [27] Filip, H. (1998, August). Reduced relatives: Lexical constraint-based analysis. In *Annual Meeting of the Berkeley Linguistics Society* (Vol. 24, No. 1, pp. 57-68).
- [28] Fodor, J., Bever, A., & Garrett, T. G. (1974). *The psychology of language: An introduction to psycholinguistics and generative grammar*.
- [29] Fodor, J. D. (1979). *Superstrategy. Sentence Processing.*, Hillsdale, NJ: Lawrence Erlbaum.

- [30] Frazier, L. (1978). On comprehending sentences: Syntactic parsing strategies.
- [31] Frazier, L., & Fodor, J. D. (1978). The sausage machine: A new two-stage parsing model. *Cognition*, 6(4), 291-325.
- [32] Frazier, L., & Rayner, K. (1982). Making and correcting errors during sentence comprehension: Eye movements in the analysis of structurally ambiguous sentences. *Cognitive psychology*, 14(2), 178-210.
- [33] Frazier, L. (1987). Syntactic processing: evidence from Dutch. *Natural Language & Linguistic Theory*, 5(4), 519-559.
- [34] Friedmann, N., & Lukov, L. (2008). Developmental surface dyslexias. *Cortex*, 44(9), 1146-1160.
- [35] Gerth, S. (2015). Memory limitations in sentence comprehension.
- [36] Gibson, E. (1990a). Memory capacity and sentence processing. In *Proceedings of the 28th annual meeting on Association for Computational Linguistics* (pp. 39-46). Association for Computational Linguistics.
- [37] Gibson, E. (1990b). Recency preference and garden-path effects. In *Proceedings of the Twelfth Annual Conference of the Cognitive Science Society*, pages 372-379.
- [38] Gorrell, P. (1995). *Syntax and parsing* (Vol. 76). Cambridge University Press.
- [39] Grove, K. (2011). Why Unaccusatives Have it Easy: Reduced Relative Garden Path Effects and Verb Type. *University of Pennsylvania Working Papers in Linguistics*, 17(1), 16.
- [40] Hemforth, B., Fernandez, S., Clifton Jr, C., Frazier, L., Konieczny, L., & Walter, M. (2015). Relative clause attachment in German, English, Spanish and French: effects of position and length. *Lingua*, 166, 43-64.
- [41] Hwang, H., & Schafer, A. J. (2009). Constituent length affects prosody and processing for a dative NP ambiguity in Korean. *Journal of Psycholinguistic Research*, 38(2), 151-175.
- [42] Hwang, H., & Steinhauer, K. (2011). Phrase length matters: the interplay between implicit prosody and syntax in Korean “garden path” sentences. *Journal of Cognitive Neuroscience*, 23(11), 3555-3575.
- [43] Inoue, M. (1990). Kouzou-teki aimai bun-no rikai-ni okeru gaaden pasuka. *Proceedings of the 32nd Nippon Kyouiku Shinri Gakkai*, 1990.
- [44] Inoue, A. (1991). A comparative study of parsing in English and Japanese.

- [45] Inui, T., Otsu, Y., Tanaka, S., Okada, T., Nishizawa, S., & Konishi, J. (1998). A functional MRI analysis of comprehension processes of Japanese sentences. *NeuroReport*, 9(14), 3325-3328.
- [46] Jegerski, J. (2012). The processing of subject–object ambiguities in native and near-native Mexican Spanish. *Bilingualism: Language and Cognition*, 15(4), 721-735.
- [47] Joshi, A. K., Levy, L. S., & Takahashi, M. (1975). Tree adjunct grammars. *Journal of computer and system sciences*, 10(1), 136-163.
- [48] Just, M. A., & Carpenter, P. A. (1987). *The psychology of reading and language comprehension*. Allyn & Bacon.
- [49] Kamide, Y., & Mitchell, D. C. (1997). Relative clause attachment: Non-determinism in Japanese parsing. *Journal of Psycholinguistic Research*, 26(2), 247-254.
- [50] Kamide, Y., & Mitchell, D. C. (1999). Incremental pre-head attachment in Japanese parsing. *Language and cognitive processes*, 14(5-6), 631-662.
- [51] Kazanina, N., Lau, E. F., Lieberman, M., Yoshida, M., & Phillips, C. (2007). The effect of syntactic constraints on the processing of backwards anaphora. *Journal of Memory and Language*, 56(3), 384-409.
- [52] Kazanina, N., & Phillips, C. (2010). Differential effects of constraints in the processing of Russian cataphora. *Quarterly Journal of Experimental Psychology*, 63(2), 371-400.
- [53] Kiaer, J. (2007). *Processing and interfaces in syntactic theory: The case of Korean* (Doctoral dissertation, King's College London (University of London)).
- [54] Koh, S. (1997). The resolution of the dative NP ambiguity in Korean. *Journal of Psycholinguistic Research*, 26(2), 265-273.
- [55] Konieczny, L. (1996). *Human sentence processing: A semantics-oriented parsing approach*. PhD thesis, University of Freiburg, Freiburg, Germany.
- [56] Konieczny, L., Hemforth, B., & Strube, G. (1991). Psychologisch fundierte Prinzipien der Satzverarbeitung jenseits von Minimal Attachment. *Kognitionswissenschaft*, 1(2), 58-70.
- [57] Konieczny, L., Scheepers, C., Hemforth, B., & Strube, G. (1994). Semantikorientierte Syntaxverarbeitung. In *Kognitive Linguistik* (pp. 129-158). VS Verlag für Sozialwissenschaften, Wiesbaden.
- [58] Kush, D., Lidz, J., & Phillips, C. (2017). Looking forwards and backwards: The real-time processing of Strong and Weak Crossover. *Glossa* (London), 2(1).

- [59] Larson, R. K. (1988). On the double object construction. *Linguistic inquiry*, 19(3), 335-391.
- [60] Lasnik, H., & Kupin, J. J. (1990). A Restrictive Theory of Transformational Grammar. In *Essays on Restrictiveness and Learnability* (pp. 17-41). Springer Netherlands.
- [61] Lasnik, H., & Saito, M. (1994). *Move alpha: Conditions on its application and output* (No. 22). MIT press.
- [62] Lee, T. T. (2006). A note on garden path sentences in Chinese. *Linguistic studies in Chinese and neighboring languages: Festschrift in honor of Professor Pang-Hsin Ting on his seventieth birthday*, 491-518.
- [63] Lewis, R. L. (1992). Recent developments in the NL-Soar garden path theory (No. CMU-CS-92-141). CARNEGIE-MELLON UNIV PITTSBURGH PA DEPT OF COMPUTER SCIENCE.
- [64] MacDonald, M. C., Pearlmutter, N. J., & Seidenberg, M. S. (1994). The lexical nature of syntactic ambiguity resolution. *Psychological review*, 101(4), 676.
- [65] Marcus, M. P. (1980). *Theory of syntactic recognition for natural languages*. MIT press.
- [66] Marcus, M. P., Hindle, D., & Fleck, M. M. (1983, June). D-theory: Talking about talking about trees. In *Proceedings of the 21st annual meeting on Association for Computational Linguistics* (pp. 129-136). Association for Computational Linguistics.
- [67] Mazuka, R., & Itoh, K. (1995). Can Japanese Speakers Be Led Down the Garden Path? In R. Mazuka, & N. Nagai (Eds.), *Japanese Sentence Processing* (pp. 295-329). Hillsdale, NJ: Lawrence Erlbaum Associates.
- [68] Milne, R. W. (1982). Predicting garden path sentences. *Cognitive Science*, 6(4), 349-373.
- [69] Mobbs, I. J. (2015). *Minimalism and the Design of the Language Faculty* (Doctoral dissertation, Ph. D. dissertation: University of Cambridge).
- [70] Mulders, I. C. M. C. (2002). *Transparent parsing: Head-driven processing of verb-final structures* (Doctoral dissertation).
- [71] Phillips, C. (1996). *Order and structure* (Doctoral dissertation, Massachusetts Institute of Technology).
- [72] Phillips, C., Wagers, M. W., & Lau, E. F. (2011). Grammatical illusions and selective fallibility in real-time language comprehension. *Experiments at the Interfaces*, 37, 147-180.

- [73] Pritchett, B. L. (1988). Garden path phenomena and the grammatical basis of language processing. *Language*, 539-576.
- [74] Pritchett, B. L. (1991). Head position and parsing ambiguity. *Journal of Psycholinguistic Research*, 20(3), 251-270.
- [75] Pritchett, B. L. (1992). *Grammatical competence and parsing performance*. University of Chicago Press.
- [76] Reinhart, T. M. (1976). *The syntactic domain of anaphora* (Doctoral dissertation, Massachusetts Institute of Technology).
- [77] Reinhart, T. (2006). *Interface strategies*. Cambridge, MA: Mit Press.
- [78] Ross, J. R. (1967). *Constraints on variables in syntax*.
- [79] Sadeh-Leicht, O. (2007). The psychological reality of grammar: The theta principle in parsing performance (Vol. 152). *LOT*.
- [80] Schriefers, H., Friederici, A. D., & Kuhn, K. (1995). The processing of locally ambiguous relative clauses in German. *Journal of Memory and Language*, 34(4), 499-520.
- [81] Siloni, T. (2004). *Grammatical Processing: Down the Garden Path*. In Aboh, E. O., Guasti, M. T., & Roberts, I. (Eds.). (2014). *Locality*. Oxford University Press. 274-302.
- [82] Stabler, E. P. (1994). *Parsing for incremental interpretation*. Ms. UCLA.
- [83] Stevenson, S. (1994). Competition and recency in a hybrid network model of syntactic disambiguation. *Journal of Psycholinguistic Research*, 23(4), 295-322.
- [84] Stevenson, S. and Merlo, P. (1997). Lexical structure and parsing complexity, *Language and cognitive processes* 12(2/3): 349-399.
- [85] Stevenson, S. A. (1998). *A Competitive Attachment Model for Resolving Syntactic Ambiguities in Natural Language Parsing*.
- [86] Stowe, L. A. (1986). Parsing WH-constructions: Evidence for on-line gap location. *Language and cognitive processes*, 1(3), 227-245.
- [87] Stowell, T. A. (1981). *Origins of phrase structure* (Doctoral dissertation, Massachusetts Institute of Technology).
- [88] Sturt, P., & Crocker, M. W. (1996). Monotonic syntactic processing: A cross-linguistic study of attachment and reanalysis. *Language and Cognitive Processes*, 11(5), 449-494.
- [89] Sturt, P., Pickering, M. J., & Crocker, M. W. (1999). Structural change and reanalysis difficulty in language comprehension. *Journal of Memory and Language*, 40(1), 136-150.

- [90] Suh, S. (1994). *The Syntax of Korean and Its Implications for Parsing Theory*, Ph.D. dissertation, University of Maryland, College Park.
- [91] Suh, S. (2003). The distribution of multiple subject constructions in Korean. *LANGUAGE RESEARCH-SEOUL-*, 39(4), 839-858.
- [92] Suh, S. (2005). The minimal chain principle and parsing Korean. *LANGUAGE RESEARCH-SEOUL-*, 41(2), 363.
- [93] Szterman, R., & Friedmann, N. (2014). Relative clause reading in hearing impairment: different profiles of syntactic impairment. *Frontiers in psychology*, 5, 1229.
- [94] Taraban, R., & McClelland, J. L. (1988). Constituent attachment and thematic role assignment in sentence processing: Influences of content-based expectations. *Journal of memory and language*, 27(6), 597-632.
- [95] Tokimoto, S. (2004). Reanalysis costs in processing Japanese sentences with complex NP structures and homonyms: Individual differences and verbal working memory constraints. *Japanese Cognitive Science Society Technical Report*, 53.
- [96] Traxler, M. J., Pickering, M. J., & Clifton, C. (1998). Adjunct attachment is not a form of lexical ambiguity resolution. *Journal of Memory and Language*, 39(4), 558-592.
- [97] Van Gompel, R. P., Pickering, M. J., Pearson, J., & Liversedge, S. P. (2005). Evidence against competition during syntactic ambiguity resolution. *Journal of Memory and Language*, 52(2), 284-307.
- [98] Wagers, M. W., & Phillips, C. (2009). Multiple dependencies and the role of the grammar in real-time comprehension. *Journal of Linguistics*, 45(2), 395-433.
- [99] Wanner, E. (1988). *Psychology and linguistics in the sixties. The Making of Cognitive Science*. Cambridge (Mass.), 143.
- [100] Warner, J., & Glass, A. L. (1987). Context and distance-to-disambiguation effects in ambiguity resolution: Evidence from grammaticality judgments of garden path sentences. *Journal of Memory and Language*, 26(6), 714-738.
- [101] Weinberg, A. (1993). Parameters in the theory of sentence processing: Minimal commitment theory goes east. *Journal of Psycholinguistic Research*, 22(3), 339-364.
- [102] Weinberg, A. (1995). Licensing constraints and the theory of language processing.

## תקציר

בתזה זו חקרתי את מנגנוני העבודה של המעבד התחבירי האנושי. לשם כך, השתמשתי במשפטים כגון אלו מתוך (Siloni 2004):

- (1) כיוון שההנהלה מפטרת עובדים המשתתפים במחאה זעמו.
- (2) ללא תורם דם קשה להשגה.

המשפטים לעיל נקראים משפטי garden path. המעבד האנושי מצליח לנתח משפטים כאלו רק לאחר קושי משמעותי וניתוח מחדש של המשפט, המתבצע באופן מודע. תופעת ה-garden path מעוררת שתי שאלות עיקריות:  
ראשית, בהינתן רצף מילים רב משמעי (כגון "ללא תורם דם"), מה מכריע איזה ניתוח המעבד יאמץ? מדוע המעבד מעדיף באופן עקבי את הניתוח לפיו "דם" הינו חלק מהצירוף "תורם דם", על פני הניתוח לפיו הוא הנושא של הפסוקית העיקרית, כמו במשפט (2)?  
שנית, אילו משפטים יגרמו לאפקט garden path? במשפטים רבים בשפה טבעית ישנה רב משמעות מקומית, ובחלק מהמשפטים המעבד אף מבצע ניתוח מחדש של המבנה התחבירי, ובכל זאת איננו חווים קושי מודע כאשר אנו מעבדים אותם. מה מבדיל משפטי garden path ממשפטים אחרים?

מרבית המחקר בנושא זה הסתמך על עדויות משפות head-initial כגון אנגלית. בעבודה זו, אני בוחן שלוש תאוריות שמנסות לספק תשובות לשאלות שתוארו לעיל: התאוריות של Pritchett (1992), של Gorrell (1995) ושל Siloni (2004), ומראה כי כל השלוש מתקשות להסביר נתונים שעולים משפות head-final כגון יפנית.

לאחר מכן, אני מציג את הצעתי לגבי מנגנון הפעולה של המעבד האנושי. אני בוחן את האופי האינקרמנטלי של המעבד, ומספק עדויות לעיבוד אינקרמנטלי הכרחי, כלומר, עיבוד המצריך בהכרח כל אלמנט למבנה התחבירי ללא דיחוי. באופן ספציפי, אני מסתמך על משפטי garden path בשפות head-final בכדי להמחיש שהמעבד מצריך אלמנטים לצירופים עוד בטרם מופיע הראש של הצירופים האלו.

אני טוען שהמעבד בונה תאור עץ מבני במהלך העיבוד, ומציע אלגוריתם שמסביר כיצד המעבד מתמודד עם ריבוי משמעות מבנית. ניתוח מחדש של המבנה התחבירי אפשרי במהלך העיבוד רק אם הוא כולל הוספה של יחסים לתאור העץ, או מחיקת יחסים בקונפיגורציה מבנית מסויימת מאוד. היחסים והקונפיגורציה המבנית הם יחסים מבניים בסיסיים כמו שליטה ו-c-command. מן הממצא הזה עולה שיש שימוש באותם יחסים מבניים גם בייצור וגם בעיבוד של משפטים.

ההצעה הנוכחית מסבירה בהצלחה נתונים הן משפות head-initial כמו אנגלית ועברית, והן משפות head-final כגון יפנית, קוראנית וסינית.

אוניברסיטת תל אביב

הפקולטה למדעי הרוח ע"ש לסטר וסאלי אנטין

החוג לבלשנות

## **עיבוד אינקרמנטלי הכרחי, מחיקה בלתי מודעת**

### **c-command-1**

חיבור זה הוגש כעבודת גמר לקראת התואר  
"מוסמך אוניברסיטה" באוניברסיטת ת"א

על ידי:

**עומר רוזנבוים**

בהנחיית:

**פרופ' טל סילוני**

יולי 2018